

EasyMax 402

Personal Synthesis Workstation



METTLER TOLEDO

Table of Contents

1	Introduction	3
1.1	Scope of delivery	3
1.2	Check on arrival	4
2	Safety Information	5
2.1	Definition of signal warnings and symbols.....	5
2.2	Intended use	5
2.3	Product-specific safety.....	5
3	Design and Function	8
3.1	Overview.....	8
3.2	Operating principle.....	9
3.2.1	Thermostat	9
3.3	Temperature modes	9
3.3.1	Tr mode	9
3.3.2	Tj mode	9
3.3.3	Distill / Reflux mode (Tj-Tr)	10
3.4	Safety system	10
3.4.1	Chemical safety	10
3.4.2	Intrinsic safety	10
3.4.3	Emergency program A	11
3.4.4	Emergency program E	11
4	Installation	12
4.1	Installation requirements.....	12
4.2	Unpacking and transporting device	12
4.3	Connecting power to the device	12
4.4	Connecting a flowmeter	13
4.5	Installing instrument cooling	13
4.5.1	Connecting in-house coolant supply.....	14
4.5.2	Connecting cryostat cooling	14
4.6	Connecting instrument purge.....	15
4.7	Connecting reactor purge	15
4.8	Connecting touchscreen to EasyMax	16
4.9	Assembling the stirrer	16
4.10	Installing a Tr sensor.....	17
4.11	Installing a two-piece 400 mL reactor	17
4.12	Installing a PTFE cover	17
4.13	Installing one-piece reactors.....	18
4.13.1	Installing a half moon stirrer blade	18
4.14	Turn on Device	19
5	Operation	20
5.1	Change safety settings.....	20
5.1.1	Change safety temperature (T safe)	20
5.1.2	Change reaction temperature limits (Tr)	20
5.1.3	Change range of jacket temperature (Tj)	21
5.1.4	Change T diff max.....	21
5.1.5	Change Rsafe	22
5.1.6	Change Rmax.....	22
5.2	Experiment.....	22
5.2.1	Select Reactor Type	22
5.2.2	Start an experiment	23
5.2.3	Stirring.....	23
5.2.3.1	Change stirrer speed.....	23
5.2.3.2	Create a stirrer speed ramp.....	24
5.2.4	Add a time marker.....	24
5.2.5	Manual sampling.....	26
5.2.6	Manual add.....	26

5.2.7	End an experiment	27
5.2.8	Export data from a defined time frame	27
5.2.9	Export single experiments	28
5.3	Heating and cooling.....	28
5.3.1	Change Tj	28
5.3.2	Create a Tj Ramp	28
5.3.3	Change Tr	29
5.3.4	Create a Tr Ramp	29
5.3.5	Disable Tr	30
5.3.6	Create a distill / reflux operation	31
5.4	Trend graph	31
5.4.1	Enter trend graph screen	31
5.4.2	Select trend graph	31
5.4.3	Navigation in trend graphs	32
5.4.4	Add notes in trend graph view	32
5.4.5	Change color of trend graphs	33
5.4.6	Take snapshot	33
5.4.7	Export snapshot.....	33
5.4.8	Experiment time and time of day	33
5.5	Task sequence	34
5.5.1	Preparing a task sequence	34
5.5.2	Edit steps in a task sequence	35
5.5.3	End a task sequence	35
5.6	Settings	35
5.6.1	Change network settings	35
5.6.2	Change time settings	36
5.6.2.1	Change date and time.....	36
5.6.2.2	Change time zone	36
5.6.2.3	Change date format	37
5.6.2.4	Change time format	37
5.6.3	Change language.....	37
5.6.4	Change keyboard layout	38
5.6.5	System information	38
5.6.5.1	Export logfiles	39
6	Maintenance	40
6.1	Update Firmware.....	40
6.2	Checking the Reactor.....	40
6.3	Cleaning the Instrument	40
6.4	Replacing O-ring and sealing ring of the stirrer adapter	40
6.5	Replacing the upper coupling of the stirrer motor	41
6.6	Changing coolant	42
6.7	Disposal	42
7	Troubleshooting	43
8	Accessories	44
9	Technical Data	46
9.1	Thermostat.....	48
9.2	Reactors	48
9.3	Stirrer	49
9.4	Cooling	49
9.5	Purge gas.....	49

1 Introduction







The METTLER TOLEDO EasyMax 402 is an easy-to-use personal synthesis workstation that allows you to run two reactions simultaneously in an accurate and reproducible way. The EasyMax 402 has two reactor positions that can be controlled independently designed for a variety of reactors and vials. The unique cooling principle allows to run experiments from -40 °C to 180 °C without the use of oil or ice baths, or a bulky cryostat. Additionally, control your experiments with an intuitive touchscreen.

The main features of the EasyMax 402 are:

- Two independently controlled reactor zones (for 100 mL and/or 400 mL one or two-piece reactors with glass or PTFE covers)
- Overhead stirring
- No oil or ice baths
- Easy touchscreen control
- Full compatibility with selected METTLER TOLEDO devices, including the DU SP-50, ECB, EasySampler and the SevenExcellence pH meter

1.1 Scope of delivery

The following items are included in the EasyMax 402 Basic and EasyMax 402 Advanced thermostat set:

Order number		Description	Quantity
		EasyMax 402 thermostat	1
51161883		TFT touchscreen 7", 1 m cable	1
11132570		Protective cover for touchscreen	1
51191125		PVC hose, soft, for reflux condenser, 5 m	1
51161187		PVC industrial hose for coolant, 15 bar, 2.5 m	2
51192239		PVC industrial hose for purge gas, 18 bar, 2 m	1
51161186		PVC hose for purge gas, 2 m	2
51191373		Y-piece for gas tubing	2

51191916		Reducing connector for purge gas tubing	1
51161827		Flowmeter set	1
51190324		Quick connect coupling for purge gas inlet	4
51192126		Hose clamp for PVC tube	8
51191915		Flow indicator for coolant	1
51191914		Knurled screw, M6 x 10 (already mounted)	3
		User Manual	1

If an item is missing, please contact your local support team.

1.2 Check on arrival

Check the following conditions once the package has arrived:

- The package is in good condition.
- The contents show no signs of damage (e.g. broken covers, scratches, etc.)
- The content is complete (see [Scope of delivery Page 3]).

If any one of these condition is not fulfilled, please contact your local support team.

2 Safety Information

This thermostat has been tested for the intended purposes described in this document. However, this does not absolve you from the responsibility of performing your own tests of the product supplied by us regarding its suitability for the methods and purposes you intend to use it for. You should therefore observe the following safety measures.







We, Mettler-Toledo GmbH, accept no liability whatsoever if you do not observe the following rules and safety notes for safe operation of the thermostat.

2.1 Definition of signal warnings and symbols

Safety notes are indicated by signal words and warning symbols and contain warnings and information about safety issues. Ignoring safety notes can lead to personal injury, damage to the instrument, malfunctions and erroneous results.

WARNING	A hazardous situation with medium risk, possibly resulting in death or severe injury if not avoided.
CAUTION	A hazardous situation with low risk, resulting in minor or moderate injury if not avoided.
NOTICE	A hazardous situation with low risk, resulting in damage to the instrument, other material damage, malfunctions and erroneous results, or loss of data.
Note	(no symbol) for useful information about the product.

Meaning of safety symbols

	Electrical Hazard		Explosion		Burns / Hot Surface
	Rotating parts		Heavy load		General note

2.2 Intended use

The METTLER TOLEDO EasyMax 402 is a reactor system for performing parallel synthesis, with 100-mL and 400-mL glass reactors.

The device is designed to be used in a laboratory environment and operated in a fume hood. All users should be trained to work in a laboratory and with this device.

Always operate and use your device in accordance with the instructions contained in this manual; use it only together with equipment specified in this documentation.

Any other type of use and operation beyond the limits of these technical specifications without the written consent from Mettler-Toledo GmbH is considered as not intended.

2.3 Product-specific safety



WARNING

Risk of electric shock

- 1 Make sure to plug the power cable supplied into a power supply outlet that is grounded. A technical fault could otherwise result in serious injury or death.
- 2 Only use the METTLER TOLEDO power supply cable and AC power adapter designed for your instrument.



WARNING

Power failure

A power failure can lead to explosion with possibly fatal consequences.

- Implement appropriate measures like an uninterruptible power supply (UPS).



WARNING

Risk of explosion with critical reactions

Performing critical reactions could lead to explosions.

- Perform a safety analysis before starting an experiment with high hazardous potential for example by using a Differential Scanning Calorimeter.



WARNING

Risk of explosion due to damaged reactors

Explosion of a reactor could cause serious injury.

- Check the reactor before each use for damage (scratches, formation of cracks).



CAUTION

Hot parts when working above 50 °C

Touching hot parts can cause burns.

- Do not touch the cover plate of the device, the fixing ring, the reactor covers, attachments of the reactor or the overhead stirrer if you work above 50 °C.



CAUTION

Rotating parts of stirrer

Rotating parts of a running stirrer may lead to injuries.

- 1 Do not touch rotating parts of a stirrer.
- 2 Do not wear loose clothing and make sure jewellery and long hair do not get entangled in the stirrer.



NOTICE

Wrong coolant used

High chloride concentration or some additives in the coolant can lead to corrosion of the thermostat.

- 1 Do not use solutions of NaCl, CaCl₂ or DW-Therm.
- 2 Check compatibility with the wetted parts of the coolant system.



NOTICE

Wrong connection or disconnection of cables

A wrong connection or disconnection of cables during operation could lead to instrument damage.

- 1 Before switching the device on, connect the cables of stirrers and sensors to their respective inputs and outputs.
- 2 Do not disconnect the cables while the instrument is operating.



NOTICE

Condensation of atmospheric moisture

The condensation of atmospheric moisture can cause corrosion of the instrument.

- 1 Always purge the instrument when it is in use. This removes any condensation that has formed.
- 2 Purge it with dry air, nitrogen or argon.



NOTICE

Reactor breaking due to freezing

The reactor can break or get stuck in the reactor zone of the thermostat when atmospheric moisture or any liquids freeze on the outside of the reactor or in the reactor zone of the thermostat.

- 1 Make sure the reactor zone of the thermostat and the reactor itself are clean and dry before inserting.
- 2 Make sure that when cooling below 0 °C, there is enough purge to minimize condensation.



NOTICE

Thermal shock

Glass parts of the instrument or the reactor could get damaged.

- Do not pour cold liquids into hot glassware and vice versa.



NOTICE

Risk of reactor breakage when sealed hermetically

Hermetical sealing could lead to pressure build-up when using gas or when the reactor is heated.

- Make sure venting is always possible.

3 Design and Function

3.1 Overview

Front view

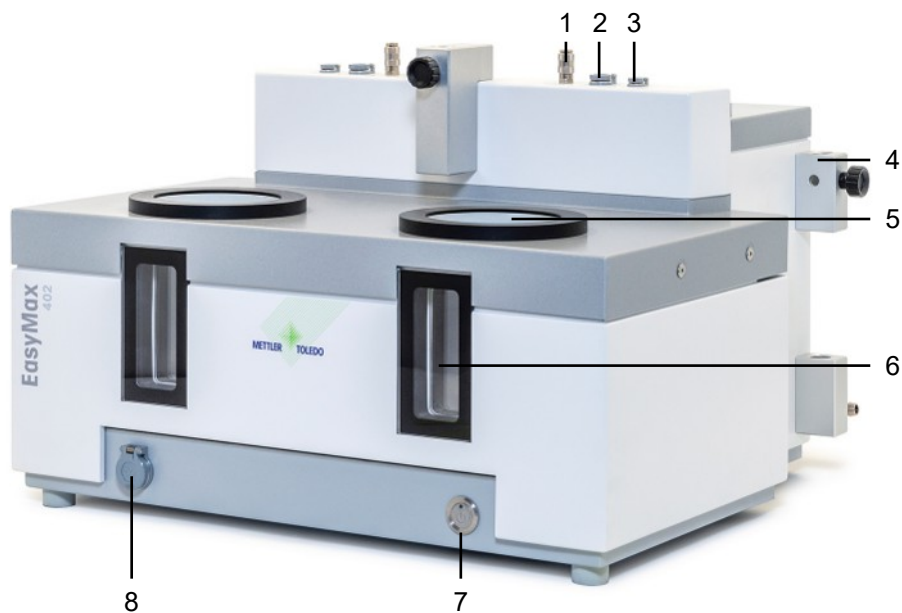

1	Reactor purge gas outlet (quick connect coupling)	2	Stirrer socket
3	Tr sensor socket	4	Holder for lab bars
5	Opening for reactors	6	Window (with backlight)
7	Power button	8	USB Socket

Back view

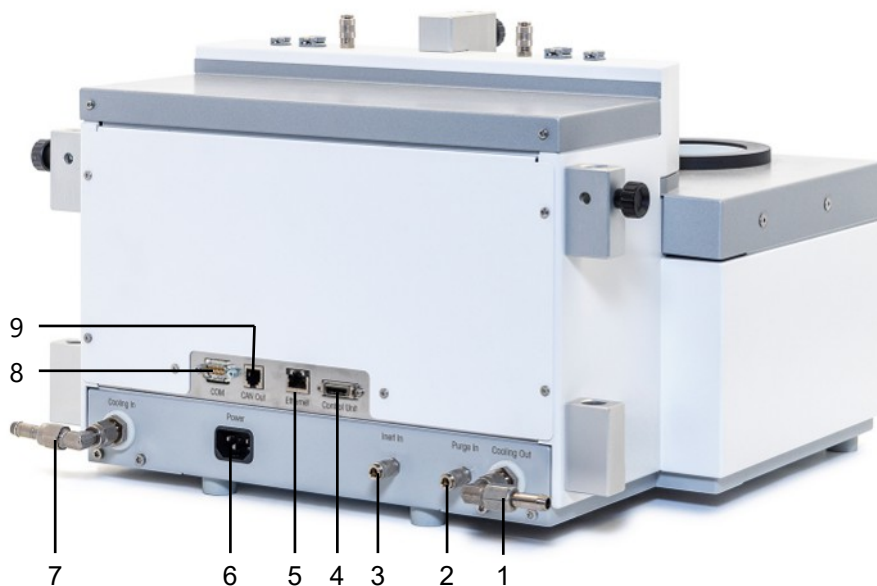

1	Cooling Out	2	Purge In connection
3	Inert In connection	4	Touchscreen connection
5	Ethernet connection	6	Power supply
7	Cooling In	8	RS232
9	CAN out		

3.2 Operating principle

The device consists of four modules:

- Electronic control unit
- Thermostat
- Measurement system
- Touchscreen

The touchscreen is used to control the device, perform experiments and managing data (storage and export of data).

For the following values the measurement system calculates the set value and acquires the actual value every 2 seconds:

- Temperature of the reaction mass (T_r)
- Temperature of the thermostat (T_j)
- Temperature of coolant (T_c)
- Stirrer speed (R)

These values are used for controlling the instrument and to trigger warnings and emergency programs.

3.2.1 Thermostat

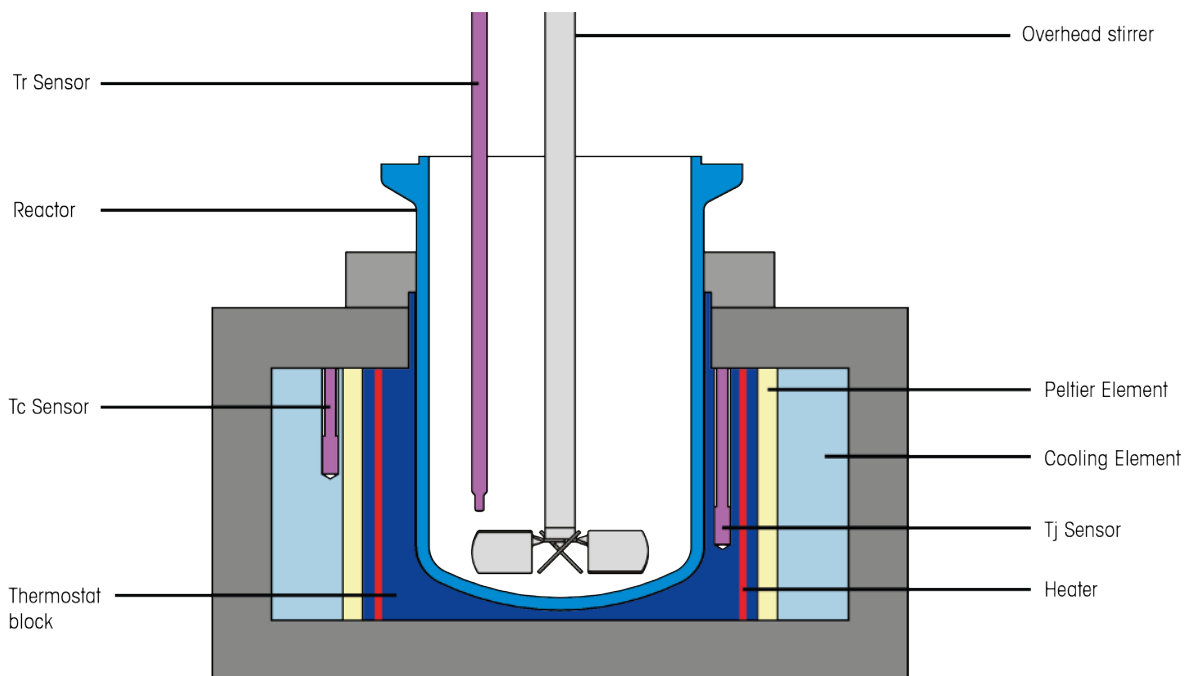

- The T_r sensor measures the temperature of the reactor contents.
- The T_j sensor measures the temperature of the reactor shell.
- The T_c sensor measures the temperature of the cooling element.

3.3 Temperature modes

3.3.1 T_r mode

The temperature of the reactor contents is controlled. Thereby T_r is held constant or changed with a ramp. Deviations of the temperature of the reactor contents from the set value (through heat of reaction) are compensated by appropriate correction of the thermostat temperature, i.e. the heat generated is dissipated.

3.3.2 T_j mode

The temperature of the thermostat is controlled. T_j is held at a specific value or changed with a temperature ramp.

3.3.3 Distill / Reflux mode (Tj-Tr)

Distill / Reflux mode can be used if you want to distill or reflux a solvent or a mixture of solvents, especially when the boiling point(s) are unknown. This mode ensures that when a boiling point is reached, the system will not continue to increase the jacket temperature but will hold the temperature when a certain difference in Tj-Tr is reached.

The value entered for the desired temperature difference between the thermostat and the reactor contents (Tj - Tr) is added to the measured temperature of the reactor contents (Tr) and gives the set value for the control of Tj. For this mode, you have to enter:

- the desired temperature difference, Tj - Tr,
- the upper limit of the jacket temperature, Tj end.

As a result, during the time when the solvent is not boiling, the temperature of the reactor contents, Tr, rises in accordance with the value entered for Tj - Tr. When the reaction mixture is boiling, Tr and hence also Tj remain approximately constant. As soon as Tj end is reached, the final (end) temperature is held.

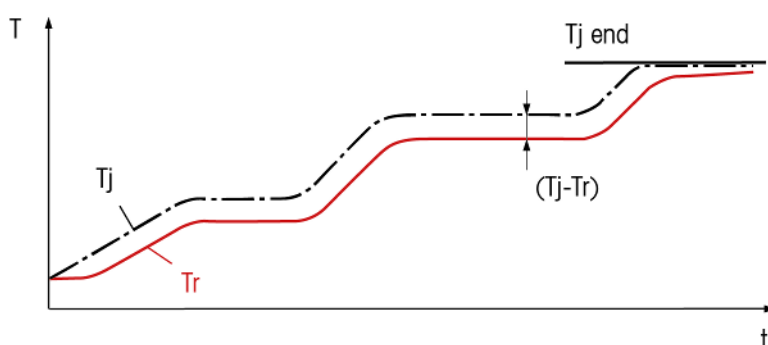

3.4 Safety system

3.4.1 Chemical safety

The safety with chemical reactions is assured by monitoring the limit values of the temperatures, the stirrer speed and the measured values of the sensors.

You should define the limit values for each new application after careful consideration of all criteria.

Measures to ensure chemical safety

- Limitation of the Tj set value to Tj end in the distillation or reflux mode.
- Monitoring the limit values for Tr, Tj and Rmax defined by you; triggering emergency programs if limit values are exceeded.
- The safety temperature Tsafe you have defined is used as set temperature for emergency program E
- Monitoring of the plausibility of your entries (prevention of typing errors that could have serious consequences).

3.4.2 Intrinsic safety

Safe operation is assured by continuously checking all the functions of the system.

For every instrument configuration, you are responsible for ensuring that the entire system is safe in case of a power-failure. Ensure that any reaction in progress can not run away.

Measures to ensure intrinsic safety

Electronics

- Monitoring the microprocessor for breakdown (watchdog).
- Monitoring of the stirrer motor.

Software

- Self-test of the microprocessor system after switching on.
- Monitoring all measured values for plausibility and failure.

- Restriction of the temperature difference " $T_j - T_r$ " to maximum 60 K in the Tr and distillation / reflux mode to avoid glass breakage.
- Error recognition and triggering of emergency programs.

3.4.3 Emergency program A

As long as emergency program A is active, errors which trigger this program cannot be reset, i.e. you have to switch off the instrument and rectify the error. An exception is the emergency program "Tc higher than Tc max". The cause for an emergency program A will most likely be a hardware issue that needs to be fixed.

Error causes and measures

Error causes	Measures to take
No connection	Switch off the instrument and restart it.
A/D converter defective	Call METTLER TOLEDO Service.
Power PIC error	Call METTLER TOLEDO Service.
Tj sensor defective	Call METTLER TOLEDO Service.
Tc sensor defective	Call METTLER TOLEDO Service
$T_c > T_c \text{ max}$ (The temperature of the coolant, T_c , is higher than the defined safety limit value , $T_c \text{ max}$)	Check the flow rate of the coolant. Press Reset, when T_c is lower than $T_c \text{ max}$ again and continue the interrupted experiment.

3.4.4 Emergency program E

Errors which trigger emergency program E can be reset, i.e. you can continue the experiment when you have rectified the error.

The cause for an emergency program E will most likely be an application fault that can be fixed by the user.

Error causes and measures

Error causes	Measures to take
Tr sensor defective or not connected	Connect the Tr sensor or connect a new one.
$T_r > T_r \text{ max}$ (The temperature of the reactor contents, T_r , is higher than the defined safety limit value $T_r \text{ max}$)	<ol style="list-style-type: none"> 1 Tap Reset. 2 Wait until $T_r < T_r \text{ max}$. 3 Continue the experiment.
$T_r < T_r \text{ min}$ (The temperature of the reactor contents, T_r , is lower than the defined safety limit value $T_r \text{ min}$)	<ol style="list-style-type: none"> 1 Tap Reset. 2 Wait until $T_r > T_r \text{ min}$. 3 Continue the experiment.
$T_j > T_j \text{ max}$ (The temperature of the thermostat, T_j , is higher than the defined safety limit value $T_j \text{ max}$)	<ol style="list-style-type: none"> 1 Tap Reset. 2 Wait until $T_j < T_j \text{ max}$ 3 Continue the experiment.
$T_j < T_j \text{ min}$ (The temperature of the thermostat, T_j , is lower than the defined safety limit value $T_j \text{ min}$)	<ol style="list-style-type: none"> 1 Tap Reset. 2 Wait until $T_j > T_j \text{ min}$. 3 Continue the experiment.

4 Installation

4.1 Installation requirements

- The device should be installed in a fume hood.
- Make sure you install the device in accordance with the technical data.

Site requirements

The instrument has been developed for indoor operation in a well-ventilated area. Avoid the following environmental influences:

- Conditions outside of the ambient conditions specified in the technical data
- Powerful vibrations
- Direct sunlight
- Corrosive gas atmosphere
- Explosive atmosphere of gases, steam, fog, dust and flammable dust
- Powerful electric or magnetic fields

4.2 Unpacking and transporting device



⚠ CAUTION

Risk of injury due to heavy load

You can injure yourself by carrying the instrument alone.

- Never try to carry the instrument alone. At least two people are needed to carry the instrument.

Unpack the device

- 1 Grip the device under the base plate.
- 2 Lift the device up and out of the foam packing material.
- 3 Place the device on the lab bench.

Transport the device

- 1 Unplug the power adapter.
- 2 Disconnect the device properly from the cooling media.
- 3 Grip the device under the base plate.

4.3 Connecting power to the device



⚠ WARNING

Risk of electric shock

- 1 Make sure to plug the power cable supplied into a power supply outlet that is grounded. A technical fault could otherwise result in serious injury or death.
- 2 Only use the METTLER TOLEDO power supply cable and AC power adapter designed for your instrument.

- 1 The power supply connection is on the back side of the device.
- 2 Connect the instrument to the power supply using the included country-specific cable.
- 3 Insert the plug of the power cable into a grounded power outlet that is easily accessible.



4.4 Connecting a flowmeter



NOTICE

Damage of Flowmeter

The flowmeter is not resistant to any liquids other than water! Do not use it with other coolants.

- 1 Screw the flowmeter with the knurled screw onto the metal holder.
- 2 Insert the holder into the space between the lab bar holders.
- 3 Slide the lab bar through the lab bar holes and the holes of the metal holder.
- 4 Tighten the screw on the lab bar holder to fasten the lab bar.

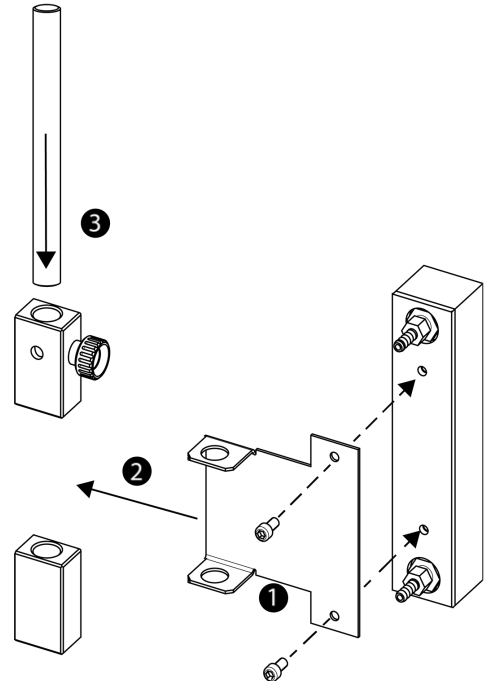

4.5 Installing instrument cooling

There are two possibilities to cool the instrument:

- Connect to in-house coolant supply
- Connect to cryostat



NOTICE

Damage of Flowmeter

The flowmeter is not resistant to any liquids other than water! Do not use it with other coolants.



NOTICE

Wrong coolant used

High chloride concentration or some additives in the coolant can lead to corrosion of the thermostat.

- 1 Do not use solutions of NaCl, CaCl₂ or DW-Therm.
- 2 Check compatibility with the wetted parts of the coolant system.

4.5.1 Connecting in-house coolant supply

The instrument needs a constant flow of the cooling medium.

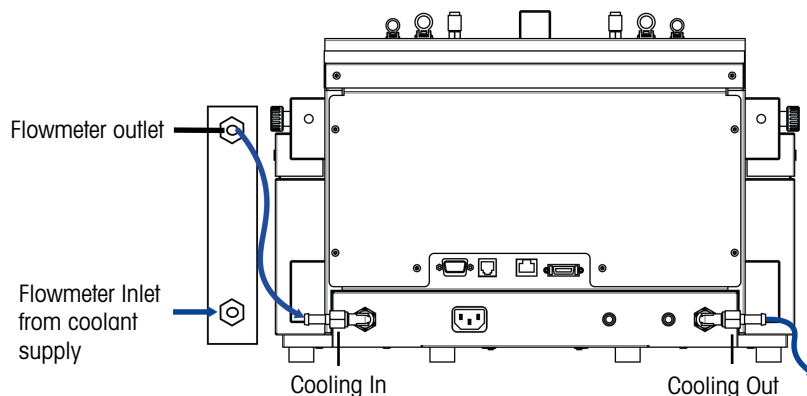

The instrument is delivered with two PVC industrial tubes. If you use the flowmeter, you need a third piece which can be cut away from one of the delivered tubes.

- 1 Push one piece of the PVC industrial hose (51161187) over the cooling inlet of the coolant flowmeter.
- 2 Secure it with a hose clamp.
- 3 Connect it to the coolant supply.
- 4 Push the cut piece of the PVC tube over the outlet of the coolant flowmeter.
- 5 Connect the other end to the elbow coupling of the **Cooling In** on the back side of the instrument.
- 6 Secure both connections with a hose clamp.
- 7 Push the other PVC tube over the elbow coupling of the **Cooling Out** on the back side of the instrument.
- 8 Secure it with a hose clamp.
- 9 Connect it to the cooling outlet of the fume hood.

4.5.2 Connecting cryostat cooling



NOTICE

Damage of Flowmeter

The flowmeter is not resistant to any liquids other than water! Do not use it with other coolants.



NOTICE

Risk of device malfunctioning

When using silicone oil as coolant adding the antistatic additive is required. It is recommended to renew the antistatic additive after a year.

- Ensure sufficient purging of the cryostat with dry nitrogen (check also instructions on purging of cryostat manufacturer).

Do not use the flowmeter with the cryostat in order to have full capacity.

The instrument needs a constant flow of the cooling medium.

- 1 Screw the insulated connection tube over the **Cooling In** on the back of the instrument.
- 2 Use a wrench to tighten the connection to the instrument.
- 3 Screw the second insulated connection tube over the **Cooling Out** on the back of the instrument.
- 4 Use a wrench to tighten the connection to the instrument.

4.6 Connecting instrument purge



NOTICE

Condensation of atmospheric moisture

The condensation of atmospheric moisture can cause corrosion of the instrument.

- 1 Always purge the instrument when it is in use. This removes any condensation that has formed.
- 2 Purge it with dry air, nitrogen or argon.

To prevent corrosion by condensed atmospheric moisture, purge the instrument with a dry gas, e.g. dry air (humidity less than 10 ppm of water), dry nitrogen or dry argon.

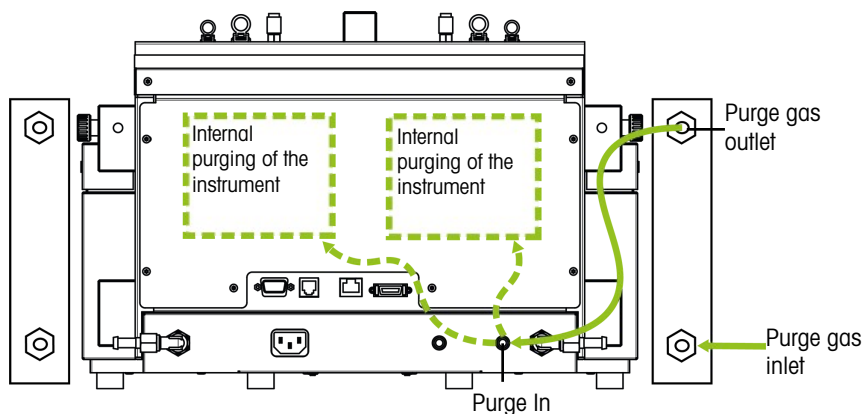

- 1 Install the quick connect coupling (51190324) with the PVC tubing (51161186) on the purge gas inlet connector.
- 2 Secure it with a hose clamp.
- 3 Connect the PVC tubing to the gas supply.

4.7 Connecting reactor purge

If you want to perform reactions, for example under nitrogen

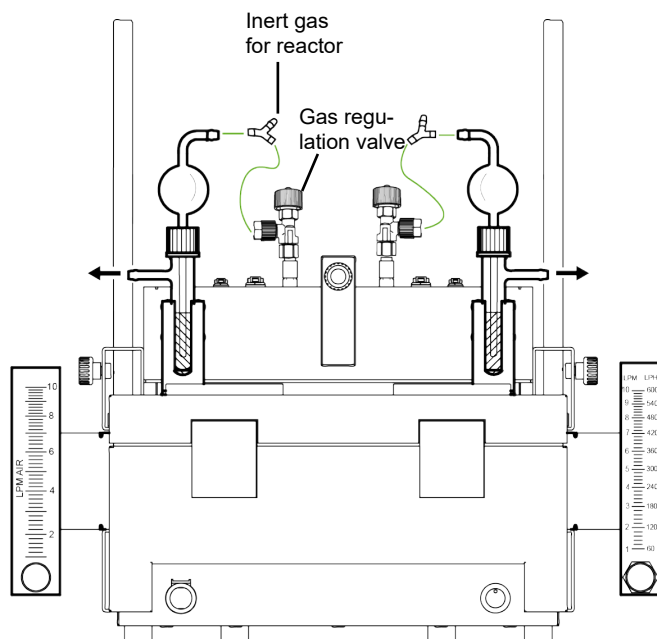

- 1 Install a quick connect coupling (51190324) with the PVC tube (51161186) on the **Inert In** connector on the back side of the instrument and secure it with a hose clamp.
- 2 Connect the other end of the PVC tube to the gas supply.

3 Connect the gas regulation valve to the purge connector on the top of the instrument.

4 Loosen the nut (4) and ferrule (2) of the gas regulation valve.

5 Slide the nut (4) and the ferrule (2) over the tubing (3).

6 Connect the tubing (3) to the gas regulation valve with the ferrule (2) sitting tightly on the outlet of the valve (1).

7 Screw the nut (4) onto the gas regulation valve outlet (1).

8 Install the bubble counter (51161802, optional available as set) to the device as shown.

9 Install the tubing and the Y-piece (51191373) as shown in the drawing. (The Y-piece guarantees an uncritical pressure for the reactor while the gas flow can be monitored with the bubble counter.)

10 Always leave a small opening in the reactor to allow a flow of the purge gas.

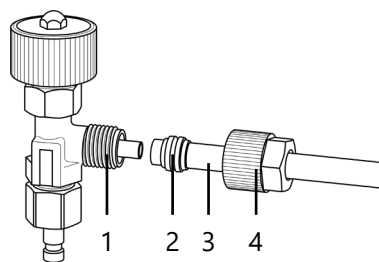

4.8 Connecting touchscreen to EasyMax

1 The touchscreen connection is on the back side of the instrument (see picture).

2 Connect the touchscreen cable to the socket.

3 Position the touchscreen so that it is always readable.



4.9 Assembling the stirrer

The overhead stirrer consists of the stirrer motor and a stirrer shaft that can be equipped with several stirrer elements (see Synthesis Workstation Catalog).

1 Screw the pitched-blade element (7) onto the stirrer shaft (6).

2 Push the stirrer shaft (6) or the glass stirrer from below through the opening of the reactor cover.

3 Push the adapter (5) with the height adjustment unit (4) over the stirrer shaft and insert it into the tapered opening of the cover.

4 Place the PA washer (3) over the stirrer shaft onto the adjustment unit (4).

5 Push the lower coupling (2) onto the stirrer shaft.

6 Push the stirrer motor (1) over the adjustment unit (4) in such a way that it snaps into its three pins.

7 Check that the stirrer blade does not touch any inserts.

8 Secure the adapter on the reactor with a Keck clamp.

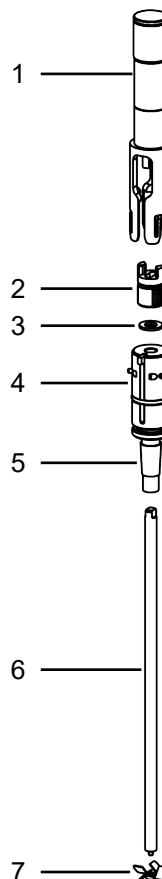

4.10 Installing a Tr sensor

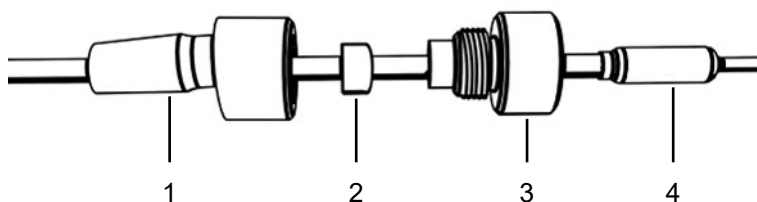

- 1 Slide a UNF 1/4" G 28 nut (**3**) over the sensor (**4**).
- 2 Slide a UNF 1/4" G 28 ferrule (**2**) over the sensor with the narrow end facing the nut.
- 3 Screw the nut lightly into the adapter (**1**) to press the ferrule into the nut.
- 4 Check that the Tr sensors does not touch the stirrer blades or other inserts.

Note Make sure the temperature sensor shows a sufficient immersion depth.

4.11 Installing a two-piece 400 mL reactor

- 1 Push the glass stirrer or the stirrer shaft with anchor or pitched-blade element through the central opening of the reactor cover before you place the cover onto the reactor.
- 2 Connect the stirrer shaft to the stirrer motor.
- 3 Place the reactor in the reactor holder.
- 4 Place the O-Ring on the cover rim and place the cover on the reactor.
- 5 Place the clamp chain carefully around the cover and the reactor flanges.
- 6 Screw the hook in or out so that the buckle can be easily closed (with one finger).

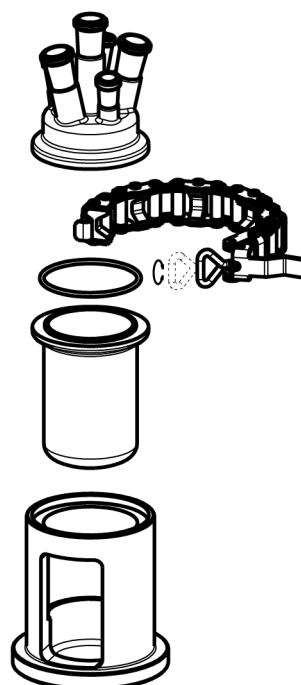

4.12 Installing a PTFE cover

PTFE covers are mainly used to run crystallization experiments. For reproducible stirring results we recommend to screw in the standard taper of the stirrer adapter in such a way that the total height of the cover is approximately 85 mm.

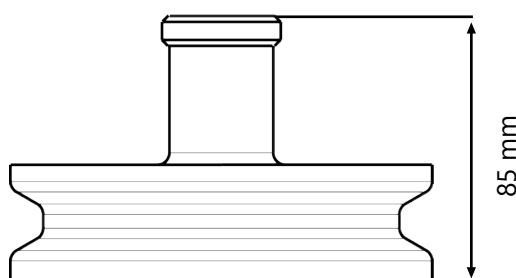

- 1 Push the glass stirrer or the stirrer shaft with anchor or pitched-blade element through the central opening of the reactor cover before you place the cover onto the reactor and connect it to the stirrer motor.
- 2 Place the reactor in the reactor holder.
- 3 Place the O-Ring on the cover rim and place the cover on the reactor.
- 4 Place the clamp chain carefully around the cover and the reactor flanges.
- 5 Screw the hook in or out so that the buckle can be easily closed (with one finger).
- 6 Close the chain/hook.

4.13 Installing one-piece reactors

The 400 mL one-piece reactor can be inserted directly into the thermostat. For the 100 mL one-piece reactor the corresponding receptacle has to be used. If not in use, the reactors can be stored in the respective reactor holder.



NOTICE

Glass breakage due to expanding material

The stirrer adapter is made of PEEK. This material can swell in combination with certain solvents, which may cause the glass to break.

- Use a PTFE stirrer adapter when working with these solvents.

- 1 Install the stirrer with a half-moon blade.
- 2 Connect the stirrer shaft to the stirrer.
- 3 Carefully insert the stirrer through the central opening.
- 4 Install the Tr sensor.
- 5 Fill the reactor with the reagents and solvents needed for the first fill.
- 6 Place the reactor in the reactor zone or place smaller reactors in a receptacle.

4.13.1 Installing a half moon stirrer blade

Glass shaft with half moon stirrer blade and PTFE shaft with half moon stirrer blade.

Install half moon blade on glass shaft

- 1 Slide the half moon blade over the glass shaft and slide it to the bottom.

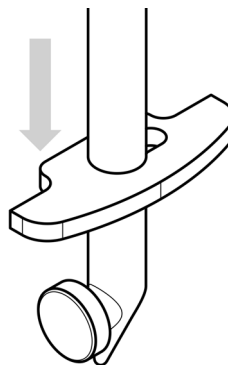

- 2 Turn the stirrer blade so that its cut-out aligns with the glass spike and move it over the glass spike.

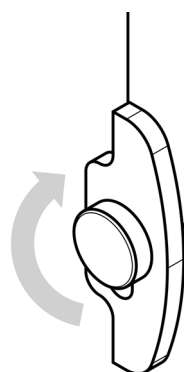

- 3 Turn the half moon blade to a horizontal position.

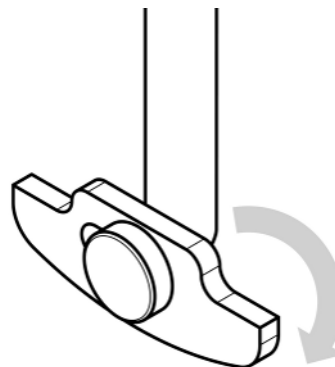

Install half moon blade on PTFE shaft

- 1 Fit the half moon blade to the bottom of the stirrer shaft.

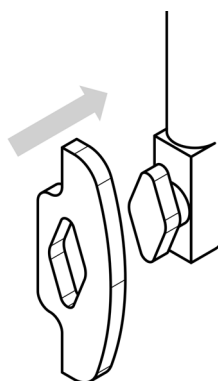

- 2 Turn the stirrer blade to a horizontal position.

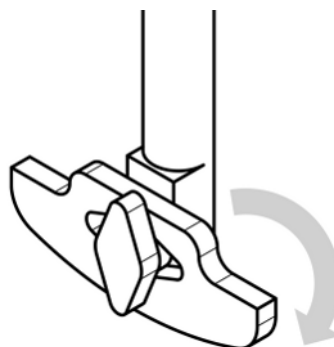

4.14 Turn on Device

- Power is connected.
- Cooling is connected and running.
- Purging of instrument is connected and running.
- Touchscreen is connected
- Press the ON/OFF button on the front side of the instrument.
 - ➔ You should hear an audible click and the LED illuminates.
 - ➔ The touchscreen shows a splash screen during start up phase.
- ➔ You can use the device as soon as the mainscreen appears.

5 Operation

5.1 Change safety settings

- 1 Tap the Reactor button.
- 2 Tap on the **Safety** field.
- 3 Change the necessary parameters according to your experiment and setup.



5.1.1 Change safety temperature (T safe)

- 1 Tap on **T safe**.
- 2 Enter a value for **T safe** that is valid for your experiment.
- 3 Tap **OK**.



Parameter	Description	Values
Tsafe	Defines the temperature to which the reaction will be cooled in case of an emergency program E.	According to your chemistry

5.1.2 Change reaction temperature limits (Tr)

- 1 Tap on **Tr max** or / and **Tr min**.
- 2 Enter a value for **Tr max** and **Tr min** that is valid for your experiment.
- 3 Tap **OK**.



Parameter	Description	Values
Trmax	Defines the maximum temperature Tr value can reach during an experiment and the user can enter in the Reactor view. If the temperature rises above that value the Emergency program E is triggered	Tsafe + 3K...183 °C
Trmin	Defines the minimum temperature the Tr value can reach during an experiment and the user can enter in the Reactor view. If the temperature falls below that value the Emergency program E is triggered.	-43 °C...Tsafe - 3K

5.1.3 Change range of jacket temperature (Tj)

- 1 Tap on **Tj min** or / and **Tj max**.
- 2 Enter a value for **Tj min** and **Tj max** that is valid for your experiment.
- 3 Tap **OK**.



Parameter	Description	Values
Tj max	Defines the maximum temperature a Tj value can reach during an experiment and the user can enter in the reactor view. If the temperature rises above that value the emergency program E is triggered.	Tsafe + 3K...183 °C
Tj min	Defines the minimum temperature the Tj value can reach during an experiment and the user can enter in the reactor view. If the temperature falls below that value the emergency program E is triggered.	-43 °C...Tsafe - 3K

5.1.4 Change T diff max

- 1 Tap on **T diff max**.
- 2 Enter a value for **T diff max** that is valid for your experiment.
- 3 Tap **OK**.



Parameter	Description	Values
T diff max	Defines the temperature difference that is allowed between Tj and Tr.	Dependent on: <ul style="list-style-type: none"> Reactor type

5.1.5 Change Rsafe

- 1 Tap on **Rsafe**.
- 2 Enter a value for **Rsafe** that is valid for your experiment.
- 3 Tap **OK**.



Parameter	Description	Values
Rsafe	Determines the stirrer speed in case of an emergency.	<ul style="list-style-type: none"> Hold rpm User-defined rpm: 0 -1000 rpm

5.1.6 Change Rmax

If you use any glass stirrer or metal anchor stirrer blade, please ensure that the Rmax is reduced to 500 rpm.

- 1 Tap on **Rmax**.
- 2 Enter a value for **Rmax** that is valid for your experiments.
- 3 Tap **OK**.

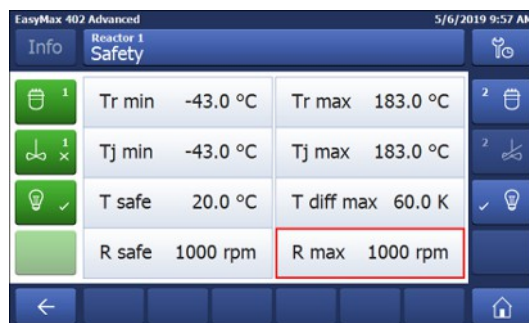

5.2 Experiment

5.2.1 Select Reactor Type

- 1 Tap the button **Reactor 400 mL**.
- 2 Tap the **Reactor type** field.

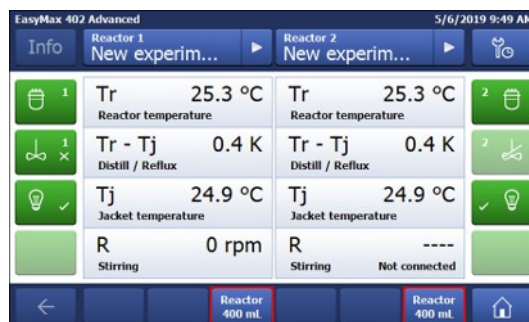

- 3 Select the reactor type that is installed.



- ➔ Make sure the safety settings for the reactor are still within the range.

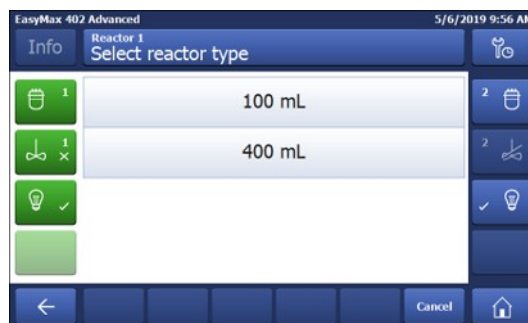

5.2.2 Start an experiment

Data that is stored outside of an experiment is lost when turning off the device. Data within the experiment is stored on the device for 10 days.

- 1 Tap the experiment button on the main screen.
 - 2 Enter an **experiment name**.
 - 3 Tap **Start** to start the experiment.
- ➔ All tasks that are executed will be saved under the experiment and available for export.

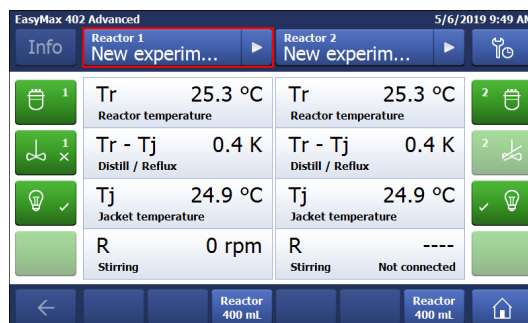

5.2.3 Stirring

5.2.3.1 Change stirrer speed

Note The value cannot be higher than the safety limit value.

- A stirrer is connected.
- 1 Tap on the **R** field.

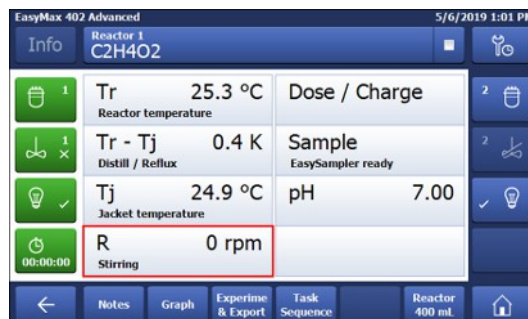

- 2 Enter the desired value.
 - 3 Tap **Start**.
- ➔ The stirrer will immediately start stirring.



5.2.3.2 Create a stirrer speed ramp

- A stirrer is connected.

- 1 Tap the **R** field.
- 2 Tap **Advanced**.

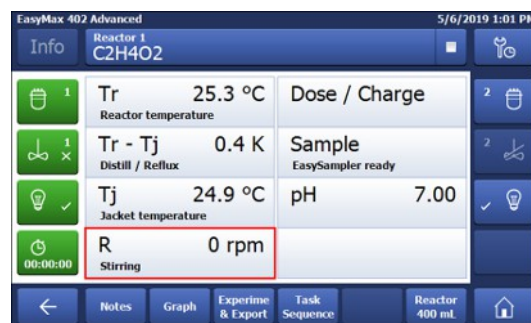

- 3 Enter a stirrer end speed (R end).
 - 4 Enter the duration of the ramp.
 - 5 Tap **Start**.
- ➔ The stirrer will immediately start stirring.



5.2.4 Add a time marker

The time marker is only active if an experiment is running.

Time markers can be added on the touchscreen with two possibilities:

- Action button in green on the left side of main screen.
- In the Trend graph viewer by tapping on the trend graph.

Parameters	Description
Time marker	The time marker allows users to define a specific moment within an experiment which he wants to refer to a time "zero" e.g. the addition of a catalyst or the nucleation of the first crystal. Once a first time marker is set, the user has an additional option to shift the timeline, setting time zero on the time marker. A user may choose to set multiple time markers, allowing to shift time zero to different spots throughout the experiment.

Add time marker on main screen

- 1 Tap on the time marker symbol on the main screen.

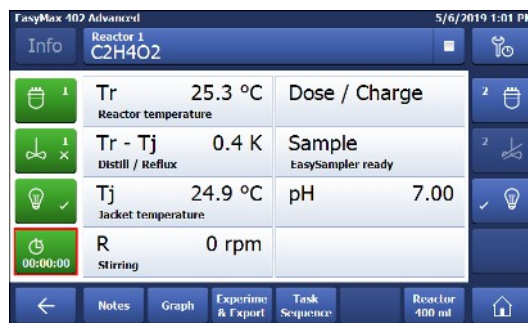

- 2 Enter a name for the time marker.
- 3 Tap **OK** to add the time marker to the experiment.



Add time marker in the trend graph

- 1 Tap on the **Graph** button.
- 2 Tap in the graph area where you would like to set a time marker.



- 3 Choose time marker from the options.

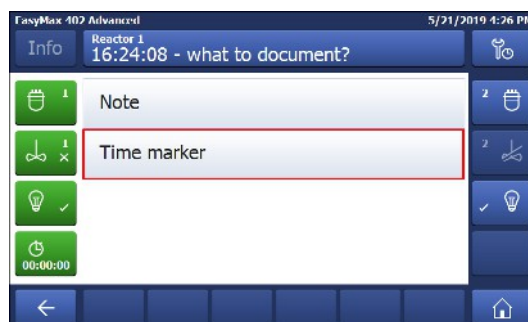

- 4 Enter a name for the time marker.
- 5 Tap **OK** to add the time marker to the experiment.



5.2.5 Manual sampling

- 1 Tap on **Sample** on the mainscreen.
- 2 Change the name of the sample or use the default name.
- 3 Tap **OK**.

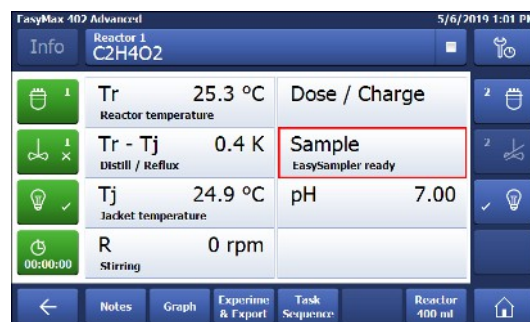

Check manual samples

- 1 Tap **Sample** on the main screen.
 - 2 Tap **List** at the bottom left of the screen.
- ➔ All samples are shown with name and time stamp.

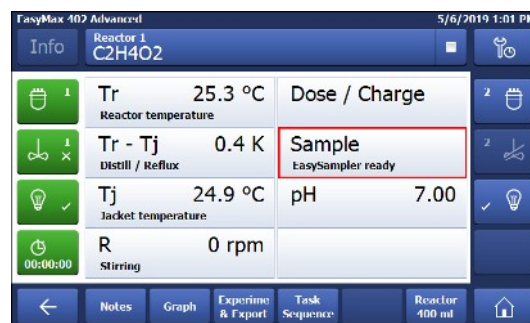

5.2.6 Manual add

- 1 Tap **Dose / Charge**.
- 2 Select **Manual Add**.

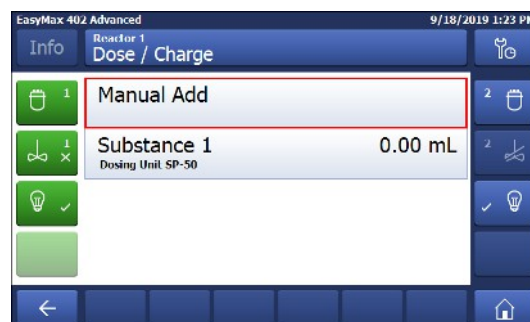
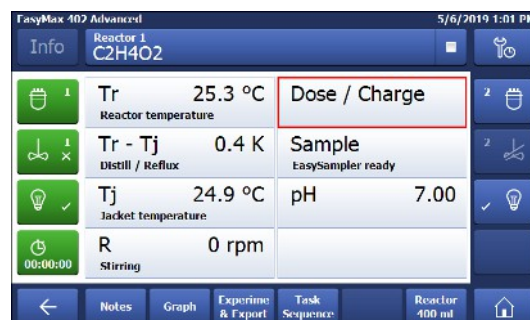

- 3 Enter the correct parameters. Per default the manual add is set to dose everything at once. If you want to change that enter a duration or rate.

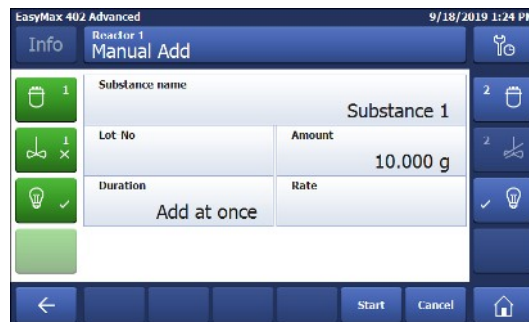

5.2.7 End an experiment

- 1 Tap on the Stop button on the mainscreen.

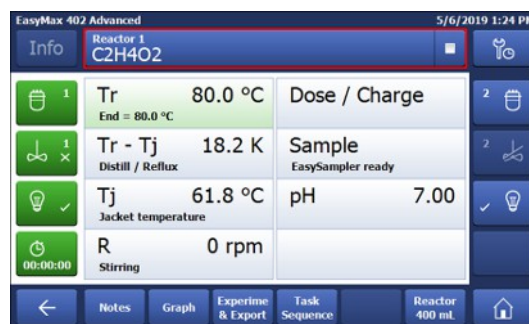

- 2 Select your preferred option for experiment end conditions.
- 3 Tap **OK**.
 ➔ Your experiment is stored on the device and can be exported.



5.2.8 Export data from a defined time frame

- An USB stick is inserted in the USB port.
- 1 Change to single reactor view.
 - 2 Tap on **Experiment & Export**.
 - 3 Choose **Export time period**.
 - 4 You can change the time period by tapping on Time period start / Time period end.
 - 5 Tap on **Start Export**.
 ➔ The touchscreen will show a message when export is finished and successful.

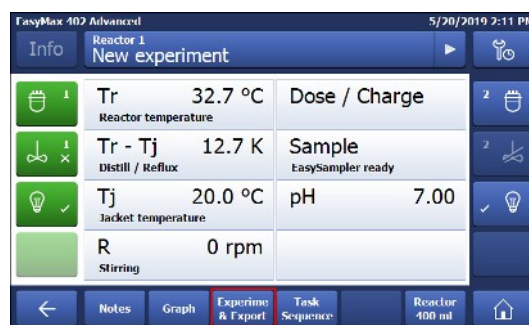

5.2.9 Export single experiments

- An USB stick is inserted in the USB port.
- 1 Change to single reactor view.
 - 2 Tap on **Experiment & Export**.

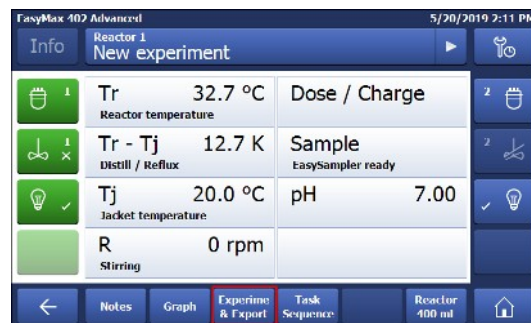

- 3 Choose **Experiment List**.
 - 4 From the **Experiment List** choose the experiment you want to export.
 - 5 Tap on **Start Export**.
- ➔ The touchscreen will show a message when export is finished and successful.

Interval time can be changed in order to minimize data volume and time for export.

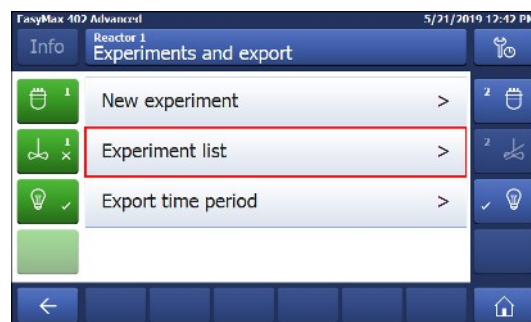

5.3 Heating and cooling

5.3.1 Change Tj

Note The value cannot be higher than the safety limit value.

- 1 Tap the **Tj** value field on the main screen.
 - 2 Enter the end temperature for **Tj**.
 - 3 Tap **Start** to initiate the task.
- ➔ The task will start immediately.

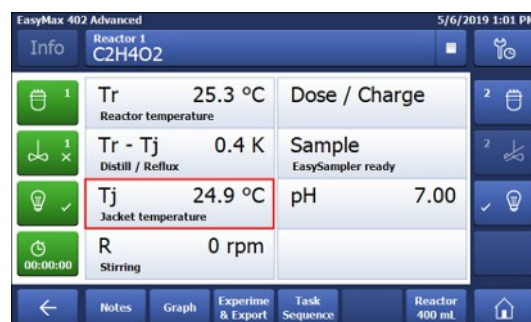

5.3.2 Create a Tj Ramp

- 1 Tap the **Tj** value field on the main screen.

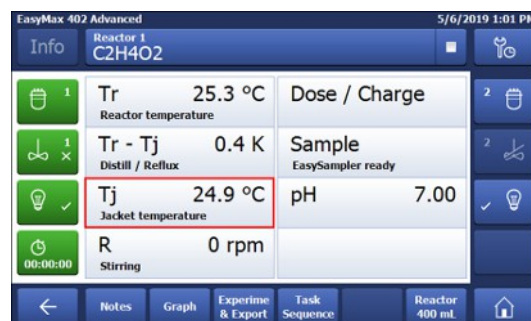

- 2 Tap **Advanced** to enter the ramp settings.

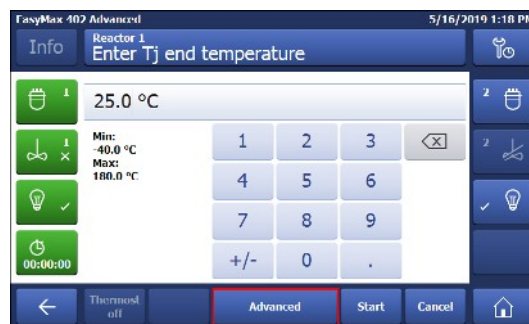

- 3 Enter the end temperature for **Tj**.
- 4 You can choose between **Duration** or **Rate**.
- 5 Tap **Start** to initiate the task.

➔ The Tj ramp will start immediately.

Using the task sequence, you can also have your ramp starting at a certain point in the reaction.



Parameters	Description
Tj end	Defines heating or cooling the reactor jacket over a certain duration or by rate.
Duration	Defines the end temperature at the end of the timespan you have entered.
Rate	Defines the end temperature is reached through the centigrade per minute you have defined.
Linear ramp	The exponent defines the shape of the curve, you can get an estimate of how the curve will look from the graphic.

5.3.3 Change Tr

Note The value cannot be higher than the safety limit value.

- A Tr sensor is connected to the thermostat.

- 1 Tap the **Tr** value field on the main screen.
- 2 Enter the end temperature for Tr.
- 3 Tap **Start** to initiate the task.

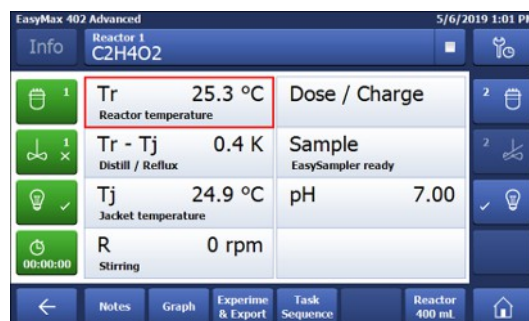

5.3.4 Create a Tr Ramp

- A Tr sensor is available.

- 1 Tap the **Tr** value field on the main screen.

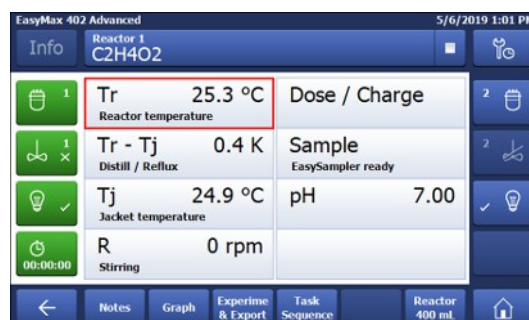

- 2 Tap **Advanced** to enter the ramp settings.

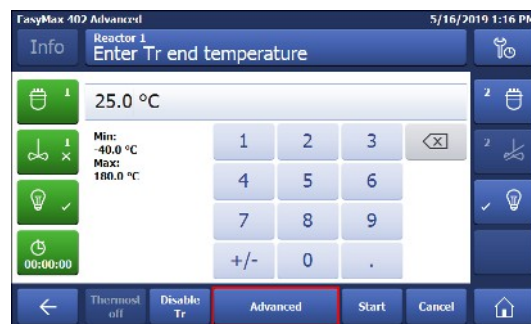

- 3 Enter the end temperature for Tr.
 - 4 You can chose between **Duration** or **Rate**.
 - 5 Tap **Start** to initiate the task.
- ➔ The Tr ramp will start immediately.



Parameters	Description
Tr end	Defines heating or cooling the reactor jacket over a certain duration or by rate.
Duration	Defines the end temperature at the end of the timespan you have entered.
Rate	Defines the end temperature is reached through the centigrade per minute you have defined.
Linear ramp	The exponent defines the shape of the curve, you can get an estimate of how the curve will look from the graphic.

5.3.5 Disable Tr

The Tr sensor can be disabled. Disabling the Tr sensor will also disable the Reflux / Distillation mode.

- 1 Tap the **Tr** value field on the main screen.

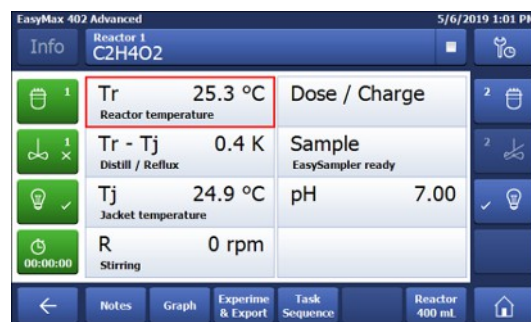

- 2 Tap **Disable Tr**.
- ➔ The Tr sensor is now disabled and will no longer show values.



5.3.6 Create a distill / reflux operation

- Tr sensor has to be connected and enabled.
- 1 Tap the Tr-Tj field.

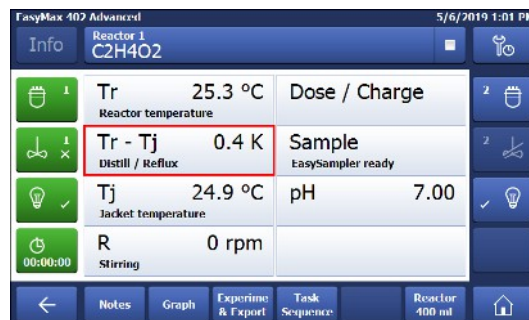

- 2 Enter a Tj end temperature.
- 3 Tap **OK**.
- 4 Tap **Distill / Reflux** and enter a Tj-Tr value appropriate for your reaction. For more details [Distill / Reflux mode (Tj-Tr) Page 10]
- 5 Tap **OK**.
- 6 When all parameters are entered correctly tap **Start**.
 - ➔ The action will start immediately.



5.4 Trend graph

5.4.1 Enter trend graph screen

- Tap on the **Graph** button.

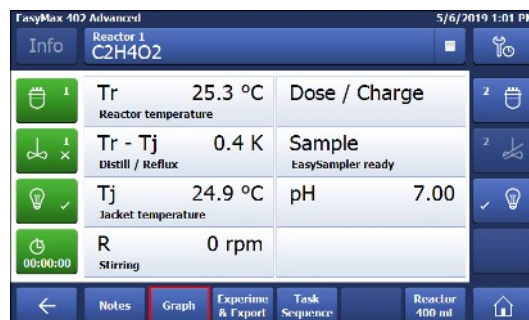

- ➔ The trend graph viewer is displayed.



5.4.2 Select trend graph

You can display four trend graphs in the trend graph viewer.

- 1 Tap on one of the parameters in the upper part of the trend graph viewer.



- 2 Tap on **Shown trend** to change the displayed trend.
- 3 Select the trend you want to display.
- 4 Tap **Apply** to display the trend graph.



5.4.3 Navigation in trend graphs

In the graph you can navigate in two ways:

- Going left or right on the time axis
- Zooming

Navigation on time axis

- Use the arrows to navigate on the time axis.



Zooming

- 1 Touch the screen with your finger and move it diagonally on the area you want to zoom on the graph.
- 2 To end the zoom tap **No zoom** to return to the normal view.

5.4.4 Add notes in trend graph view

- 1 Enter the trend graph view.
 - 2 Tap on **Note**.
 - 3 Enter your note.
 - 4 Tap **OK**.
- ➔ Notes are shown on the trend graph as red triangles.



Adding a note in the trend graph screen

- 1 Tap on the trend screen where you want to have the note.
 - 2 Choose **Note**.
 - 3 Enter your note.
 - 4 Tap **OK**.
- ➔ Notes are shown on the trend graph as red triangles.

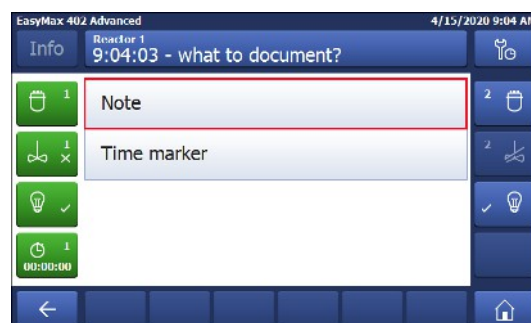

5.4.5 Change color of trend graphs

- 1 Tap on the trend graph that you want to change.
- 2 Tap on **Color**.
- 3 Select the new color of the trend graph.
- 4 Tap on **Apply**.

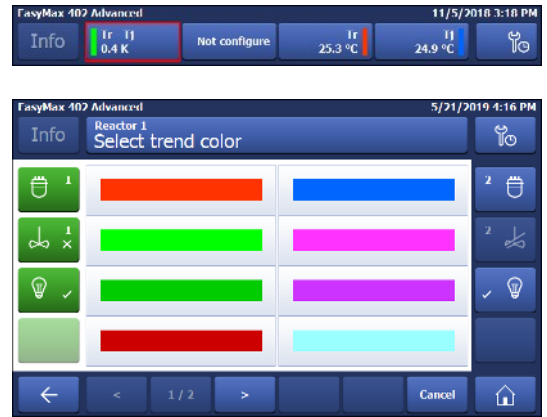

5.4.6 Take snapshot

The snapshot is taken from the whole trend graph area, if you want to have a specific part of the experiment as a snapshot you can use the zoom function.

- Tap on **Take Snapshot**.



5.4.7 Export snapshot

- An empty USB stick is inserted.
- 1 Tap **Export Snapshot**.
 - 2 Select the Snapshot you want to export from the list.
- ➔ The Snapshot is stored on the USB stick.



5.4.8 Experiment time and time of day

You can choose between two time displays:

- Time of day
 - Relative time
- You can toggle between the two time displays by tapping the button on the right bottom of the screen.



5.5 Task sequence

5.5.1 Preparing a task sequence

It is possible to preprogram a task sequence with up to 6 steps.

The following operations can be used:

- Tr (only if connected)
- Tj
- Tr - Tj
- R
- Wait
- Dosing with a DU SP-50 (only if connected)
- Dosing via an ECB (only if connected)

1 Tap on button **Task Sequence**.

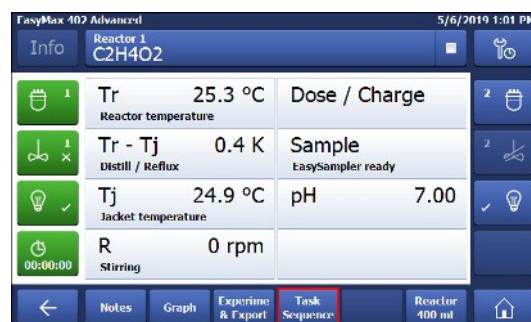

2 Tap on button **Step 1**.

3 Choose an action from the list of parameters.

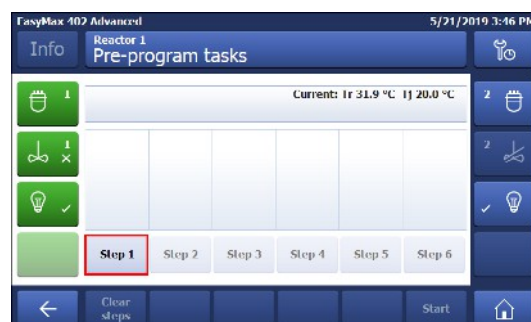

4 Enter desired values for the parameter.

5 Tap **OK**.

6 Repeat as often as needed or up to 5 times.



7 Tap **Start** to initialize your task sequence.

➔ The **Task Sequence** will start immediately.

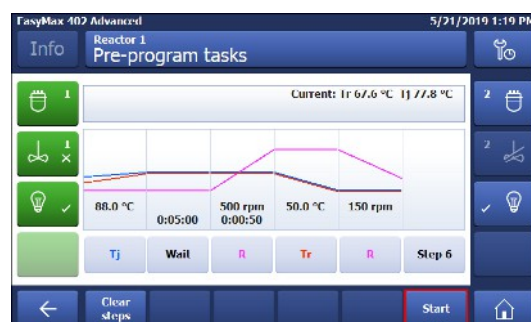

5.5.2 Edit steps in a task sequence

You can edit a step as long as it has not run yet or is not active.

- 1 Tap on the step you want to change.
 - 2 Select the correction task from the list.
 - 3 Enter the correct parameters for your experiment.
 - 4 Tap on **OK**.
- ➔ The edited step is shown in the **Task sequence**.

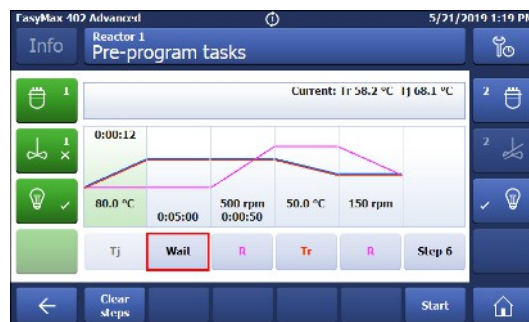

5.5.3 End a task sequence

- The task sequence is running.
 - Tap in the task sequence window on the **End Steps** button.
- ➔ The sequence will stop immediately.
- You can reactivate the steps by pressing start or delete all steps by pressing clear steps.



5.6 Settings

5.6.1 Change network settings

This function may be needed if you want to connect the instrument to the software.

The DHCP allows to automatically integrate a device into an existing network without manual configuration. When the system is started, it obtains the IP address and the subnet mask from the DHCP server.



If a DHCP server is not available, the IP address and the subnet must be manually entered.

Note Instruct the person responsible for IT to make the following settings.

For further details on how to connect the device to the network, please also check the iControl Quick Install Guide (51710672)

- 1 Tap .
- 2 Tap on **System Settings**.
- 3 Tap on **Network settings**.
- 4 Select IP-Address to enter the IP-address manually. In case DHCP is enabled, a warning screen asks you to disable it.
- 5 Enter the IP-Address and confirm it with **OK**.
- 6 Select Subnet Mask and enter the subnet mask.
- 7 Confirm your entry with **OK**.

The following icons appear in the statusbar when the device is connected to applications or a data export is in progress.

Icon	Description
	Export of experiment currently executed. This icon represents an export through USB or LAN
	iControl connection established

Icon	Description
	iC Data Center connection established

5.6.2 Change time settings

You can change different parameters:

- Date and time
- Time zone
- Date format
- Time format



NOTICE

Changing time settings

Changing the Time zone or Date and Time can lead to loss of experiment data. A warning on the touchscreen will appear.

- Make sure you have exported your experiment data.

- 1 Tap .
- 2 Tap on **System settings**.
- 3 Tap **Time settings**.
- 4 Select the time setting you want to change.



5.6.2.1 Change date and time



NOTICE

Changing time settings

Changing the Time zone or Date and Time can lead to loss of experiment data. A warning on the touchscreen will appear.

- Make sure you have exported your experiment data.

- 1 Tap on **Date and time**.
- 2 You can change the values by tapping on the plus and minus buttons.
- 3 Tap **OK**.
- 4 Tap **Apply** if you have saved your data.

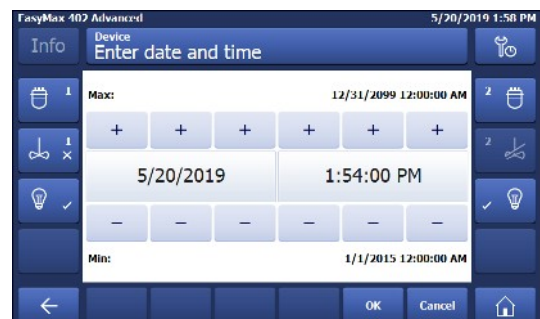

5.6.2.2 Change time zone

- 1 Tap on **Time zone**.

- 2 Select the time zone you are in. You can go through the pages by tapping the arrow button.
- 3 Tap **Apply**.



5.6.2.3 Change date format

- 1 Tap on **Date format**.
 - 2 Choose one of the formats.
 - 3 Tap **Apply**.
- ➔ The date format is changed. This change has no influence on the data storage.

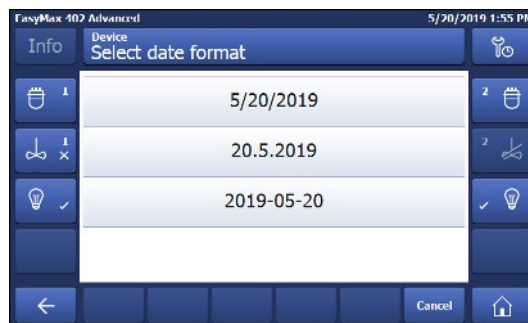

5.6.2.4 Change time format

- 1 Tap on **Time format** to toggle between the English version with AM/PM or the standard version with just the numbers.
- 2 If you change the Time format, the display of Date and Time will be updated accordingly.

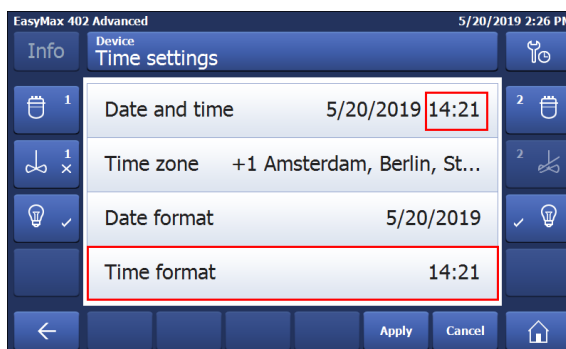
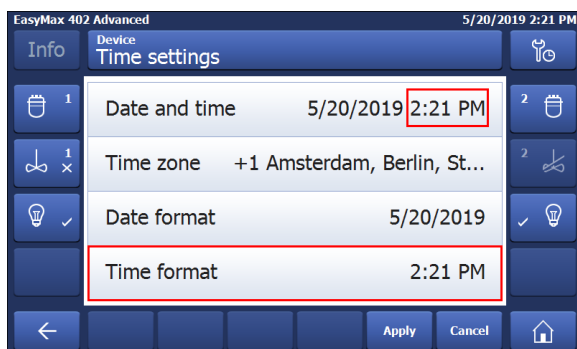

5.6.3 Change language

- 1 Tap .
- 2 Tap on **System settings**.
- 3 Tap **Language settings**.

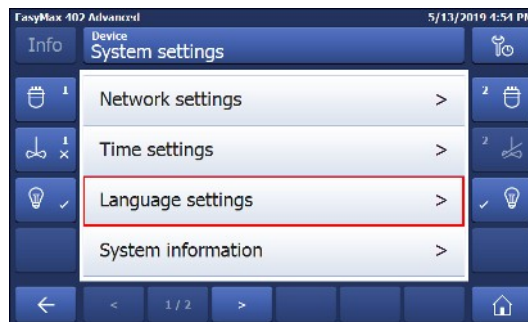

4 Tap **Language**.



5 Select the desired language. The following languages are available:

- English
- German
- Spanish
- French
- Japanese
- Chinese



5.6.4 Change keyboard layout

- 1 Tap .
- 2 Tap on **System settings**.
- 3 Tap **Language settings**.
- 4 Tap on **Keyboard**.

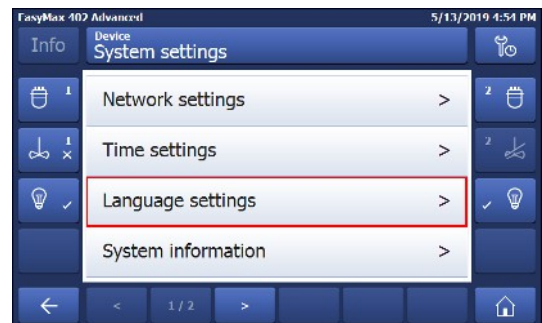

- 5 Choose one of the three layouts.
➔ The setting is automatically applied.



5.6.5 System information

- 1 Tap .
- 2 Tap on **System settings**.
- 3 Tap **System Information**.
- 4 The following information are displayed:
 - Firmware version
 - Serial number
 - Machine ID

5.6.5.1 Export logfiles

Exporting log files can be necessary if a problem with the device occurs. This helps our support to evaluate the problem.

- An USB stick is inserted in the device.
- 1 Tap .
- 2 Tap on **System settings**.
- 3 Tap **System Information**.
- 4 Tap the button **Export log files**.

6 Maintenance

Maintenance tasks have to be performed in accordance with the instructions given in this chapter. After performing any maintenance tasks, it should be ensured that the device still meets all safety requirements.

6.1 Update Firmware

The latest firmware versions and instructions for installation are available on the following website:
<https://community.autochem.mt.com/?q=software>

6.2 Checking the Reactor

To check the reactor vessel for possible damage (scratches and cracks), it must be empty, clean, dry and open. Small hairline cracks can be detected by refraction using an additional light source (focused, not dispersed light).

6.3 Cleaning the Instrument



CAUTION

Hot instrument parts

Touching hot parts of the instrument can result in burnings.

- Do not clean the instrument before all parts have reached room temperature.



NOTICE

Damage to the device due to incompatible cleaning agents

Inappropriate cleaning agents could damage the housing of the device.

- 1 Use the described cleaning agent.
- 2 Should you use other cleaning agents, ensure that they are compatible with the housing material.

The housing of the instrument is not watertight (i.e. splash proof). We therefore recommend that you clean it with a damp cloth using ethanol.

If you have questions about the compatibility of cleaning agents, contact your authorized METTLER TOLEDO dealer or service representative.

6.4 Replacing O-ring and sealing ring of the stirrer adapter

We recommend that you change the O-ring and the sealing ring at regular intervals, especially if you have to perform reactions under tight system conditions.

- 1 Press the locking lever of the height adjustment unit and pull the adapter completely down, turn it slightly to the left and remove it from the locking device.
- 2 Loosen the O-ring from the groove of the PTFE adapter by applying pressure to the inner circumference of the O-ring with a size 0 screwdriver as shown (see picture).
- 3 Remove the PTFE sealing ring and replace both rings. (The rings are delivered as a unit under 51191375.)
- 4 Press the ring unit into the adapter.
- 5 Push the height adjustment unit over the adapter again.
- 6 Push down the locking lever and turn the height adjustment unit until its lower pin is in the groove of the adapter; turn it slightly to the right, then push it upward and let go the locking device.

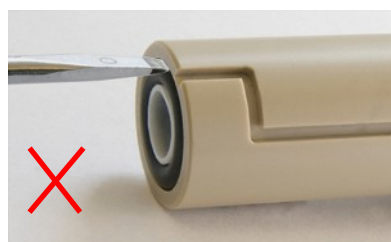
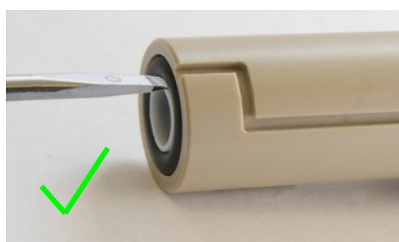

6.5 Replacing the upper coupling of the stirrer motor

If the upper coupling of the stirrer motor is damaged, for example by chemicals, you can replace it (51161360).

- 1 Disconnect the stirrer from the thermostat.
- 2 Pull the adapter with the height adjustment unit, stirrer shaft and lower coupling out of the stirrer motor.



- 3 Loosen the setscrew using a 2-mm Allen wrench and remove the coupling from the motor shaft.



- 4 Push the new coupling over the motor shaft with the round part in front so that its thread is on the flat part of the shaft.
- 5 Push the coupling over the motor shaft until it is flush with it.
- 6 Tighten the setscrew using the Allen wrench.



6.6 Changing coolant

If you change the coolant, you must rinse and dry the tubing in the instrument before you use the new coolant.

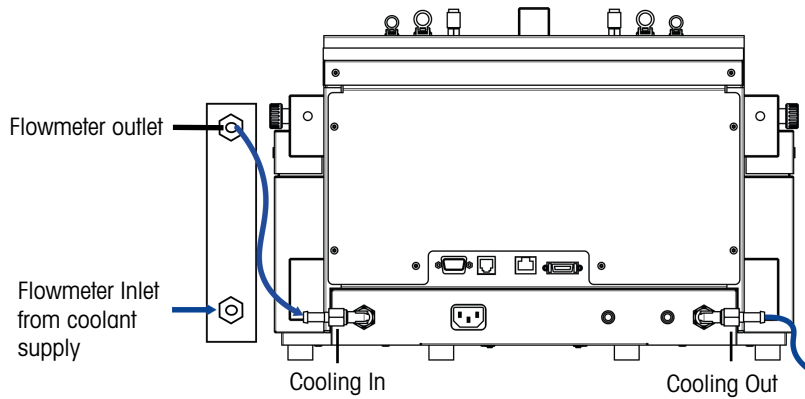

- The device is turned off.
- The device is disconnected from power.
- 1 Stop the flow from the coolant supply.
- 2 Remove the connection tube first at the **Cooling In** inlet, and then at the **Cooling Out** outlet.
- 3 Rinse and dry the tubing in the reverse direction (from the **Cooling Out** outlet).
- 4 Reconnect the connection tubing to the new coolant supply.
- 5 Make sure that your system is tight.

6.7 Disposal

In conformance with the European Directive 2012/19/EU on Waste Electrical and Electronic Equipment (WEEE) this device may not be disposed of in domestic waste. This also applies to countries outside the EU, per their specific requirements.

Please dispose of this product in accordance with local regulations at the collecting point specified for electrical and electronic equipment. If you have any questions, please contact the responsible authority or the distributor from which you purchased this device. Should this device be passed on to other parties, the content of this regulation must also be related.



7 Troubleshooting

Instrument inoperative	If the instrument does not start when you switch it on: <ol style="list-style-type: none"> 1 Check the power supply before 2 Call the METTLER TOLEDO Service.
No display on touchscreen	– Make sure the touchscreen cable is connected to the instrument before calling the METTLER TOLEDO Service.
Cooling below Tc not possible	– Call the METTLER TOLEDO Service.
Wrong Tr measurement value	<ol style="list-style-type: none"> 1 Check the immersion depth: The Tr sensor must be sufficiently immersed in the reaction mass. 2 Check the value with a reference thermometer. <p>➔ If its values are correct, the sensor is defective.</p>
Window of the thermostat fogged	– Make sure the thermostat is purged or increase the purge rate
Stirrer inoperative	If the stirrer does not operate after switching on the instrument: <ol style="list-style-type: none"> 1 Make sure the stirrer isn't blocked. 2 Call the METTLER TOLEDO Service.
Heating inoperative	If the heater is inoperative: – Call the METTLER TOLEDO Service.

8 Accessories

The synthesis workstation catalog provides a full overview of the available and compatible accessories to your device.

Temperature sensors



Tr sensor, FEP coated, 3.2x175 mm

51161730



Tr sensor, FEP coated, 3.2x250 mm

30111612



Tr sensor, glass, 6x260 mm

30099798



Tr sensor, Alloy C-22, 6.35x260 mm

30090590

Wear parts



PTFE sealing for stirrer adapter ST14

51191375



Upper coupling incl. 2 screws

51161360

Calorimetry



Upgrade Kit EasyMax HFCal:

30090576

- Module HFCal
- Temperature sensor, glass
- Calibration heater, Alloy C-22
- Adapter ST14/23 with sealing ring, PTFE
- CAN cable, 100 cm



Calibration heater, Alloy C-22, 6.35 x 260 mm, 10 W

30090579

Dosing and Sampling



ECB

30212440



Dosing unit SP-50

51161770



EasySampler

30083901

Software

Additional purchased software or upgrade licenses are sent out electronically by e-mail.

9 Technical Data

Certifications regarding this product can be found at <https://www.mt.com/us/en/home/search/compliance.html/>
The product name of your device is the model number.

Directives, standards and REACH regulation

SVHC candidate substances according to REACH (Article 33)

Material	CAS No.
Decamethylcyclopentasiloxane	541-02-6
Dodecamethylcyclohexasiloxane	540-97-6
Octamethylcyclotetrasiloxane	556-67-2

United States of America

This equipment has been tested and found to comply with the limits for a **Class B** digital device, pursuant to part 15 of the FCC Rules. These limits are designed to provide reasonable protection against harmful interference in a residential installation. This equipment generates, uses and can radiate radio frequency energy and, if not installed and used in accordance with the instructions, may cause harmful interference to radio communications. However, there is no guarantee that interference will not occur in a particular installation. If this equipment does cause harmful interference to radio or television reception, which can be determined by turning the equipment off and on, the user is encouraged to try to correct the interference by one or more of the following measures:

- Reorient or relocate the receiving antenna.
- Increase the separation between the equipment and receiver.
- Connect the equipment into an outlet on a circuit different from that to which the receiver is connected.
- Consult the dealer or an experienced radio/TV technician for help.

Changes or modifications not expressly approved by the party responsible for compliance could void the user's authority to operate the equipment.

Power supply

AC Power Adapter rating	Voltages	100 - 240 VAC
	Frequency	50 Hz / 60 Hz
	Permissible voltage fluctuation	±15%
Instrument rating	Power Consumption	Max. 1000 VA

Connections

USB	Support of USB 2.0
Electrical connectors	RS232, USB, CAN, Ethernet and touchscreen
Cable length	Limited to 3 m for RS232, USB, CAN

Ambient Conditions

Humidity	Max. relative humidity 80 % for temperatures up to 31 °C decreasing linearly to 50 % relative humidity at 40 °C, non-condensing
Altitude	Up to 2000 m
Overvoltage category	II
Pollution degree	2
Ambient temperature	5 °C...40 °C
Usage	For indoor use only

Materials

Cover plate	Stainless steel coated with PFA/FEP
Housing material	Powder-Coated stainless steel
Connectors for purge gas	Stainless steel, nickel-plated brass
Purge gas lines	PVC, FEP, PP, PVDF, PTFE, aluminum

Coolant system (wetted parts)	PVC, PTFE, PVDF, copper
Cooling connector	Nickel-plated brass
Holder for lab bars	Aluminium
LEMO connectors for Tr sensor and overhead stirrer	Chrome-plated brass with protection cap in PSU
Reactor window	Borosilicate glass 3.3
Receptacles for reactors	Anodized aluminum
Fixing rings of thermostats	PTFE C25
USB connector	Stainless steel with protection cap in PSU
On/Off switch	Stainless steel
Reactors	Borosilicate glass 3.3 and PTFE
Overhead stirrer shaft	Borosilicate glass 3.3, Alloy 22 or PTFE
Touchscreen	PA 12, aluminum
Protective cover for Touchscreen	Barex®

Device

Weight incl. Touchscreen	20 kg
Backlight	2 LED per reactor

Dimensions

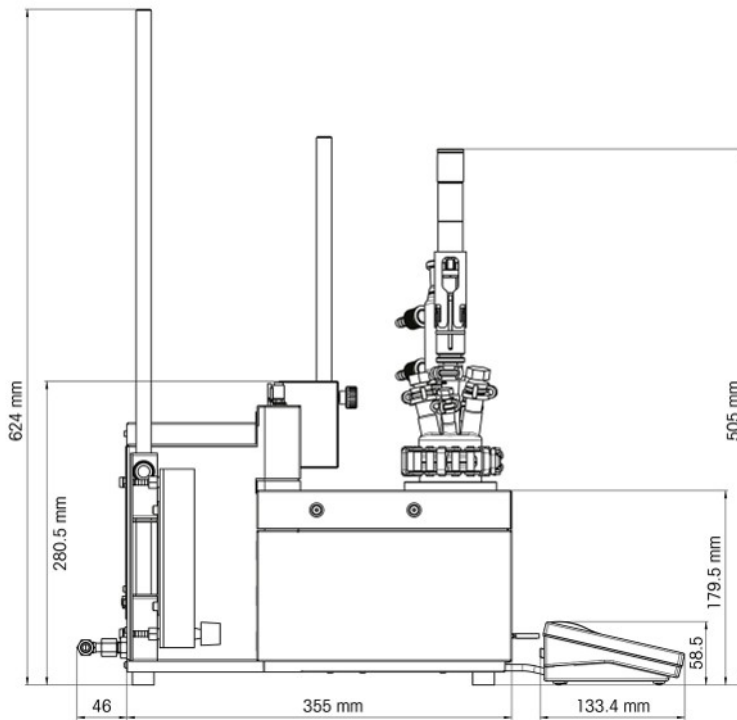

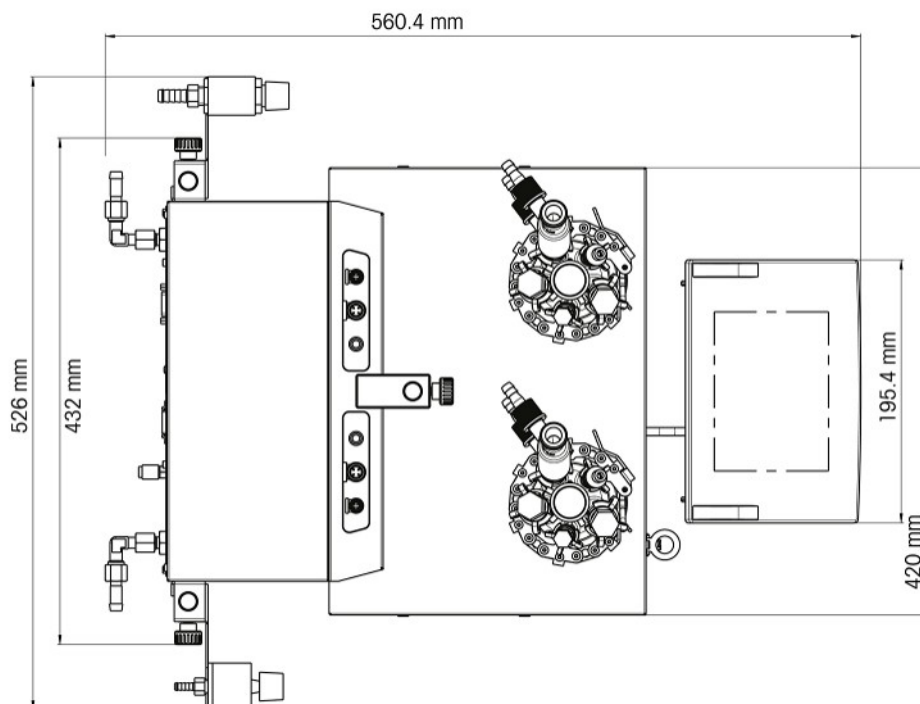

9.1 Thermostat

Power

Heating	360 W per thermostat
Cooling	Max. 150 W per thermostat

Temperatures

Range	Tj: - 40 °C (with Tc < -15 °C) to 180 °C Tr: - 40 °C (with Tc < -15 °C) to 180 °C* Tc: - 40 °C to 60 °C * The maximum and minimum Tr depends on heat transfer through the jacket and heat generated by the reaction.
Resolution	Tj: 0.1 K Tr: 0.1 K
Maximum permissible errors	±1.0 K for the whole range, for Tr and Tj sensor
Data recording interval	Every 2 seconds

9.2 Reactors

Volumes	400 mL 100 mL
Pressure	0.05 bar to ambient pressure

Cover of reactors

100 mL glass cover	<ul style="list-style-type: none"> • 2 x ST10/9 • 3 x ST14/23 <ul style="list-style-type: none"> – 1x ST14/23: Central port for stirrer
--------------------	---

100 mL PTFE cover	<ul style="list-style-type: none"> • 1 x ST10/9 • 3 x ST14/23 <ul style="list-style-type: none"> – 1x ST14/23: Central port for stirrer • 2 x ST19/26
100 mL PTFE 19 mm cover	<ul style="list-style-type: none"> • 1 x ST10/19 • 2 x ST14/23 • 1 x 1/2" NPT • 1 x 19.25 mm • 1 x ST14 with 3/8" NPT: Central port for stirrer
400 mL glass cover	<ul style="list-style-type: none"> • 4 x ST14/23 <ul style="list-style-type: none"> – 1x ST14/23: Central port for stirrer • 2 x ST19/26
400 mL PTFE cover	<ul style="list-style-type: none"> • 3 x 1/2" NPT • 2 x 3/4" NPT • 1 x ST 14/35: Central port for stirrer

9.3 Stirrer

Overhead stirrer

Operating mode	Control to constant value or ramp
Data recording interval	Every 2 seconds
Speed range	50 to 1000 rpm
Torque	Max 59 mNm (for continuous operation)

9.4 Cooling

Cooling medium	<ul style="list-style-type: none"> • Water (unpolluted); otherwise install a filter • Ethylene glycol • Silicone oil <p>Other cooling media have to be compatible with the wetted materials of the cooling system Technical Data</p>
Min. flow of cooling media	2 L/min
Cooling types	In-house coolant supply or cryostat
Max. pressure of cooling media	<ul style="list-style-type: none"> • Without flowmeter: 3.5 bar • With flowmeter: 2 bar

Temperature (Tj)	In-house coolant supply	Cooling power of cryostat
> - 10 °C	At 15 °C	1000 W at 20 °C
- 40 °C	Not possible	Min. 450 W at -10 °C

9.5 Purge gas

Instrument purge gas

Max. inlet pressure	7 bar
Min. gas flow	4 L/min
Connector on device	Purge In see [Connecting instrument purge Page 15]
Humidity of purge gas	Less than 10 ppm of water

Reactor purge gas

Max. inlet pressure	7 bar
Min. gas flow	As required by experiment
Connector on device	Inert In see [Connecting reactor purge Page 15]

To protect your product's future:
METTLER TOLEDO Service assures
the quality, measuring accuracy and
preservation of value of this product
for years to come.

Please request full details about our
attractive terms of service.

www.mt.com

For more information

Mettler-Toledo GmbH

Im Langacher 44
8606 Greifensee, Switzerland
www.mt.com/contact

Subject to technical changes.
© Mettler-Toledo GmbH 11/2021
30092610D



30092610