



Commander

Automatic Wrapper
User's Guide

METTLER TOLEDO

©2012 Mettler-Toledo, LLC

No part of this manual may be reproduced or transmitted in any form or by any means, electronic or mechanical, including photocopying and recording, for any purpose without the express written permission of Mettler-Toledo, LLC

U.S. Government Restricted Rights: This documentation is furnished with Restricted Rights.

Fold this flap first at line



NO POSTAGE
NECESSARY
IF MAILED
IN THE
UNITED STATES

BUSINESS REPLY MAIL
FIRST-CLASS MAIL PERMIT NO. 414 COLUMBUS, OH

POSTAGE WILL BE PAID BY ADDRESSEE

Mettler-Toledo, LLC
Retail Quality Manager - MTWR
P.O. Box 1705
Columbus, OH 43216
USA

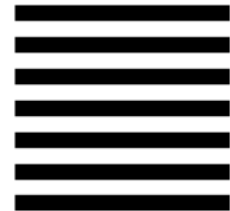

Fold at second line above and seal with tape.

Introduction

This publication is provided solely as a guide for individuals who have received Technical Training in servicing the METTLER TOLEDO product.

Information regarding METTLER TOLEDO Technical Training may be obtained by writing to:

Mettler-Toledo, LLC
1900 Polaris Parkway
Columbus, Ohio 43240
(614) 438-4511

FCC Notice

This device complies with Part 15 of the FCC Rules and the Radio Interference Requirements of the Canadian Department of Communications. Operation is subject to the following conditions: (1) this device may not cause harmful interference, and (2) this device must accept any interference received, including interference that may cause undesired operation.

This equipment has been tested and found to comply with the limits for a Class A digital device, pursuant to Part 15 of FCC Rules. These limits are designed to provide reasonable protection against harmful interference when the equipment is operated in a commercial environment. This equipment generates, uses, and can radiate radio frequency energy and, if not installed and used in accordance with the instruction manual, may cause harmful interference to radio communications. Operation of this equipment in a residential area is likely to cause harmful interference in which case the user will be required to correct the interference at their own expense.

**METTLER TOLEDO RESERVES THE RIGHT TO MAKE REFINEMENTS OR
CHANGES WITHOUT NOTICE.**

Precautions

READ this manual BEFORE operating or servicing this equipment.

FOLLOW these instructions carefully.



SAVE this manual for future reference.



DO NOT allow untrained personnel to operate, clean, inspect, maintain, service, or tamper with this equipment.

ALWAYS DISCONNECT this equipment from the power source before cleaning or performing maintenance.

CALL METTLER TOLEDO for parts, information, and service.

	NOTICE
	TO PREVENT EQUIPMENT DAMAGE Read and understand the operators manual before using the equipment. Failure to follow operating instructions could result in equipment damage.

	 WARNING
	ELECTRICAL SHOCK HAZARD Only permit qualified personnel to service this equipment. Exercise care when making checks, tests and adjustments that must be made with power on.

	 WARNING
	ELECTRICAL SHOCK HAZARD Connect to a properly grounded outlet only. Do not remove the ground prong. Power outlets must be easily accessible and located no further than the length of the power cord supplied with the product.

	 WARNING
	ELECTRICAL SHOCK HAZARD Disconnect and lock out all power to this unit before removing or installing the fuse, cleaning, or servicing.

	NOTICE
	ELECTROSTATIC SENSITIVE DEVICES Observe precautions for handling electrostatic sensitive devices.

	NOTICE
	EQUIPMENT DAMAGE Disconnect power before connecting or disconnecting any internal electronic components or interconnecting wiring between electronic equipment.

	 CAUTION
	BURN HAZARD Hot surface. Allow to cool before servicing or cleaning.

Publication Revision History

Part Number	Date	Revisions
64058950 Rev 00	08/07	New manual
64058950 Rev 01	04/08	Tray size update (ch4); Fusion GUI update (ch 6)
64058950 Rev 02	09/08	Fusion Added; Reports Chapter Added (9)
64058950 Rev 03	05/10	Images updated in Chapter 7
64058950 Rev 04	07/10	Expanded and updated Chapter 1, Chapter 2 Operation, Chapter 6 Controller, and 8 Troubleshooting. Added Fusion 4.2 enhancements. Added Chapter 10 label requirements.
64058950 Rev 05	3/11	General updates to all chapters for Version 4.2 OS. Updated screens in chapter 6 and added Linux information throughout. Updated Tray Ref Charts in Chapter 4.
64058950 Rev 06	6/11	Corrections to tray reference charts (mm) measurements Chapter 4.
64058950 Rev 06	2/12	LLC Name change and updated photos in Chapter 1 & 2.
64058950 Rev 07	4/12	Updates for Fusion 4.3 and 4.4. Updated warning labels to current ANSI standards.

Disposal



In conformance with the European Directive 2002/96/EC on Waste Electrical and Electronic Equipment (WEEE) this device may not be disposed of in domestic waste. This also applies to countries outside the EU, per their specific requirements.

Please dispose of this product in accordance with local regulations at the collecting point specified for electrical and electronic equipment.

If you have any questions, please contact the responsible authority or the distributor from which you purchased this device. Should this device be passed on to other parties (for private or professional use), the content of this regulation must also be related. Thank you for your contribution to environmental protection.

Contents

1	Overview	1-1
	Introduction	1-1
	General Specifications.....	1-2
2	Operation	2-1
	System Power Up	2-1
	317 Printer	2-2
	Safety Shut-offs.....	2-3
	Stop Switch	2-4
	Normal Shut-down.....	2-4
3	Film Loading.....	3-1
	Loading Instructions	3-1
4	Trays	4-1
	Loading the Trays	4-1
	Tray Specifications	4-2
	Tray Reference Chart – 11” Film	4-3
	Tray Reference Chart – 13” Film	4-4
5	Printers	5-1
	Introduction	5-1
	Loading Labels - 317.....	5-2
	Loading Labels – 710	5-5
6	Controller - Touchscreen	6-1
	Introduction	6-1
	Main Screen	6-2
	PLU Screen	6-3
	Options Button.....	6-4
	Tare Selector	6-5
	Place Label Button	6-6
	PLU Pricing Modes	6-7
	By-Weight PLU	6-7
	By-Count PLU.....	6-7
	Standard Pack PLU	6-7
	PLU Search Modes	6-8
	Country of Origin Labeling (COOL)	6-9
	Preconfigured COOL Statements	6-9
	Custom COOL Statements	6-11
	Forced COOL.....	6-12
	COOL PreText	6-12

Wrapper Control	6-13
Mode Buttons	6-14
Done Button	6-14
Film Setting	6-15
Status	6-16
Convey Package	6-16
Film Temperature	6-17
Error Logs	6-18
More Data	6-18
Operations Menu	6-20
Void Transactions	6-20
Verify Labels	6-21
Cutting Tests	6-21
Measure Label	6-22
Reset Printer	6-22
Setup	6-23
Unit Setup	6-23
Choose Department	6-24
Scale Mode	6-24
Price Settings	6-24
Manual Mode Keys	6-24
Tare to Use	6-24
Accumulators Setup	6-25
Void Available	6-25
Scale Settings	6-25
Printer & Label Setup	6-26
Choose Store Logo	6-26
Label Printer Setup	6-26
DayGlo Printer Setup	6-29
Bottom Label Printer Setup	6-30
Calibrate Printer Gap Sensor	6-31
Barcode Setup	6-31
Presets Setup	6-34
Preset Quick Key Editor	6-34
Pages	6-36
Keys	6-43
Backroom Setup	6-50
Choose Indexer	6-50
Date Forward Hour	6-50
Cycle Lifter, Cycle Xfer, Cycle Convey	6-50
Macros Setup	6-51
Macro Placement	6-53
Setup Passwords/Levels	6-54
Quick Edits	6-55
View Version Information	6-57
View Logs	6-57
Minimize Application	6-57

	Serial Devices Setup	6-57
	Load Cell Setup.....	6-58
	Launch External Program	6-58
	UC Editor	6-58
	UC Smartlabel	6-58
	Task Manager	6-58
	Production Reports	6-58
	Quit To Desktop.....	6-59
	Shutdown System.....	6-59
7	Cleaning and Maintenance	7-1
	Daily Cleaning	7-1
	Infeed Cleaning.....	7-5
	Controller Cleaning	7-6
	Printer Cleaning.....	7-7
8	Troubleshooting	8-1
	Printer Troubleshooting	8-1
	No Label Prints.....	8-1
	Pick/Apply Problems	8-1
	Label Placement Varies	8-2
	Label Applicator Won't Turn Labels	8-2
	Light/Mottled Print.....	8-2
	Extra Labels Print.....	8-3
	Incorrect Label Indexing.....	8-3
	Wrapper Troubleshooting	8-4
	Film Tears or Tracks Poorly.....	8-4
	Gaps in Film, Poor or No Overwrap.....	8-4
	Not Picking Film	8-4
	Error Logs	8-5
	Controller Error Log	8-5
	Wrapper System Error Log	8-6
	Wrapper Status Screens	8-7
	Commander Error Codes.....	8-7
	Commander Help.....	8-13
	Remote Access Assistance	8-13
9	Extra Programs	9-1
	Task Manager	9-1
	Overview	9-1
	Requirements and Installation.....	9-2
	Starting Task Manager.....	9-2
	Active Task View	9-3
	Add Task.....	9-4
	Edit Task.....	9-8
	Task Complete.....	9-8

Cancel a Task	9-9
Reports	9-9
Priority Escalation	9-10
Production Reports	9-11
Main Screen	9-11
Custom Production Report	9-12
Daily Production Report	9-14
Price Override Report.....	9-15
Detailed PLU Report	9-16
Department Summary.....	9-17
Setup: Configuring Reports.....	9-18
Additional Controls.....	9-22

10 Label Requirements	10-1
General Requirements	10-1
Label Paper	10-1
Adhesive.....	10-1
Release Liner	10-2
Total Thickness Label + Adhesive + Liner	10-2
Light Transmission for Gap Sensor Operation	10-2
Label Stripping	10-2
Finished Label Roll Requirements	10-3
Core and Method of Label Attachment.....	10-3
Die Cutting	10-3
Slitting	10-3
Winding	10-4
Label Curl	10-4
Splicing	10-5
Finished Label and Roll Dimensional Requirements	10-5
Preprinted Labels	10-7
Special Shaped Labels	10-9
Definition of Transmission Optical Density	10-9
Label and Liner Optical Density	10-10
Black Stripe Optical Density	10-10

METTLER TOLEDO

For your notes

1

Overview

Introduction

The METTLER TOLEDO Commander is an integrated prepack wrapper and labeling system designed to wrap items pre-placed into food grade trays. The Commander consists of three components: Model 648 Automatic Wrapper, Commander Controller Module, and Printer(s). The Commander system supports up to three printers for Data labels, DayGlo labels, and bottom labels.



Commander Automatic Wrapper

	<p>NOTICE</p> <p>TO PREVENT EQUIPMENT DAMAGE Read and understand the operators manual before using the equipment. Failure to follow operating instructions could result in equipment damage.</p>
---	--

General Specifications

The Commander wrapper is not designed to wrap loose and/or liquid products. This unit is not intended for washdown or hazardous area operation, or for operation in environments of extreme dust, heat, cold, or humidity.



Noise Level Specifications	Equivalent continuous weighted sound pressure level at the workstation is 74.4 dB. Tests performed in conformance with ISO 3746 Standard (UNI 7712-AFNOR S31-069)
Film	13 inch or 11 inch food grade stretch film from 58 to 72 gauge.
Packages Per Minute	20 maximum
Electrical and Certification	208/230 VAC, 14.1 Amps, 50/60 Hz. ETL #2002405 Conforms to UL Standard 763 and CSA C22.2 195
Voltage/Amperes	208 VAC/50-60 Hz, 20A Supply/2350 VA (default)
Internal Operating Voltage	75 VAC or 100 VAC
Operating Temperature Range	40°F to 70°F (5°C to 20°C)
Humidity	5% to 95% Non-condensing
Wrapper Weight	600 lbs
Shipping Weight with 2 printers	900 lbs

	WARNING
	<p>ELECTRICAL SHOCK HAZARD Connect to a properly grounded outlet only. Do not remove the ground prong. Power outlets must be easily accessible and located no further than the length of the power cord supplied with the product.</p>

2

Operation

System Power Up

There are two power switches on the Commander wrapper. The wrapper power switch (1) controls power to the wrapper electrical components and the printers. The controller power switch (2) is independent of the wrapper power switch and controls power only to the controller (3). Shown below are the power switch locations.



- Remove any items from the infeed belts and keep hands clear of the machine infeed and discharge areas.
- Turn the wrapper power switch to ON (1). Lift the top cover and turn the controller power switch (2) on. Check the printer(s) to make sure the LED on the front is green. If not open the door and check the printer's power switch to make sure it is on.
- After the Commander application starts, press the START button on the controller (3). The machine will initiate a Self Test and the belts and conveyors are in motion.
- Allow the sealing belt to reach programmed temperature before starting to wrap. To view the current temperature, press the Wrapper button on the controller. Adjust the temperature if needed. The temperature will display highlighted in blue if the belt is too cold and in red if the belt is too hot. When the belt reaches the assigned temperature the field will not be highlighted.

317 Printer

The printer's LED on the front of the unit will indicate the current status.

- Green** LED printer is ready.
- Orange** LED out of labels.



The 317 printer has a power switch located behind the side cover. It should be left ON for normal operation. The wrapper power switch will disconnect power to all of the printers.

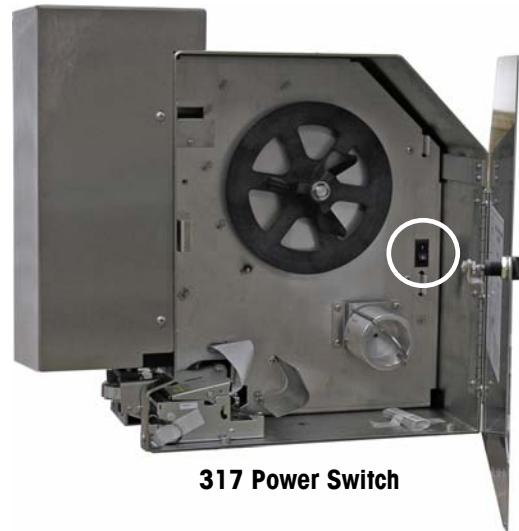

317 Power Switch

If the controller reports a printer communication error, you can sometimes clear the error by turning the printer power switch off and then back to on. In this case, you may have to reset the printer using the reset printer function on the Operations Menu (version 4.2 and later).



Safety Shut-offs

The Commander has three safety interlocks and one Stop Switch. All will stop operation of the unit if they are actuated. A safety interlock is located at the Infeed using photoeyes. Two are triggered if the top covers on the Canopy or Conveyor are opened. The Stop Switch is actuated by manually pushing it down with the palm of your hand.



	 CAUTION
	PINCH HAZARD Watch your fingers and hands. Do not put hands under or between the belts and rollers.

Stop Switch

The Commander will stop all wrapper movement immediately when the Stop Switch is pressed down.



Once depressed, the Stop Switch must be reset before operation can begin again. Follow the arrows turning the Stop Switch clockwise.

This will activate the Switch again. Then follow instructions on the controller screen to re-start the wrapper.



Normal Shut-down

The Wrapper Power Switch on the front of the Commander will turn off power to the wrapper electronics and the printers.



The Controller Switch is separate from the Wrapper Power Switch. The Controller Switch will perform a soft shut down of the operating system. The operating system can also be shut down using the Setup – Shutdown System functions on the controller. When using the machine daily, or for extended downtime, the following is recommended.

For daily use:

- Turn the Wrapper Power Switch OFF.
- Leave the Controller ON.

Extended down time (Two or more days):

- Turn the Wrapper Power Switch to OFF.
- Shut down the Controller.

3 Film Loading

Loading Instructions

The Commander is designed to work with either 11 inch (280mm) or 13 inch (330mm) food-grade stretch film from 58 to 72 gauge. For a list of approved film vendors, contact your Mettler Toledo representative. The film width of your choice will be set up at installation time by a qualified technician. Loading film is easy and once familiar with the machine, changing film will generally take less than a minute. To load film, perform the following steps. The power can be left on while loading film.



1 Open the top cover.

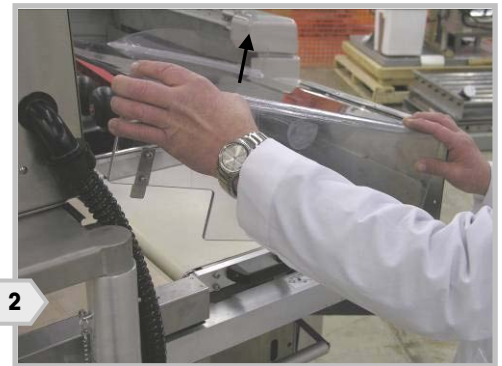

Open the transfer belt cover.

2



3 Lift the transfer belt using the handle until it locks in the raised position.

Note: if the unit has a DayGlo printer in place, remove the printer's lock pin and rotate the printer first to provide clearance to open the cover.

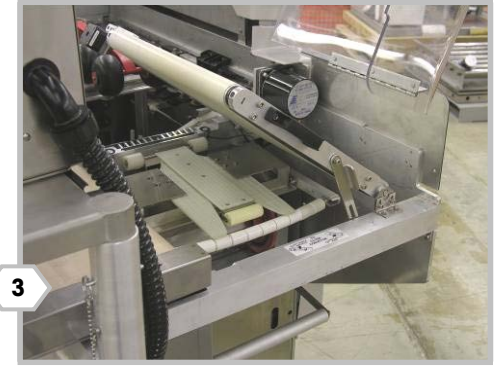

3



4 Release the film bobbin using the latch and pivot the bobbin outwards.

Hold the bobbin and rotate the hand wheel counter-clockwise to release the tension. Remove any empty film roll.

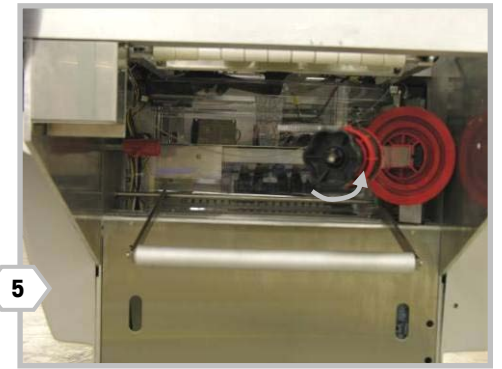

5



6 Position the new film roll so the film unrolls from the top and away from the machine.

Slide the new roll of film on the bobbin (7) until the roll contacts the stop disk.



7



8 Tighten the hand wheel (clockwise) to secure the film to the bobbin. Swing the bobbin back into the wrapper and latch film bobbin lock.

Start pulling the film and thread it first under the dancer roller.

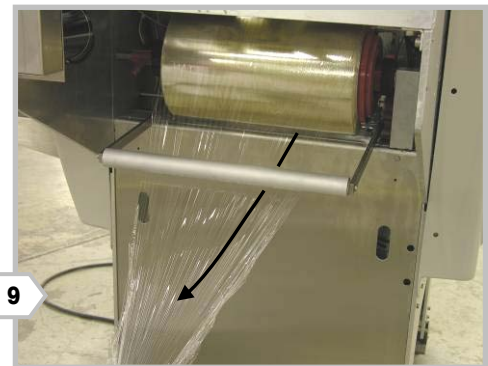

9



10 Continue pulling the film up over the curved rollers and into and through the film folders.

Lower the transfer belt by first lifting by the handle and using the tab on the locking lever to lift the lever up.

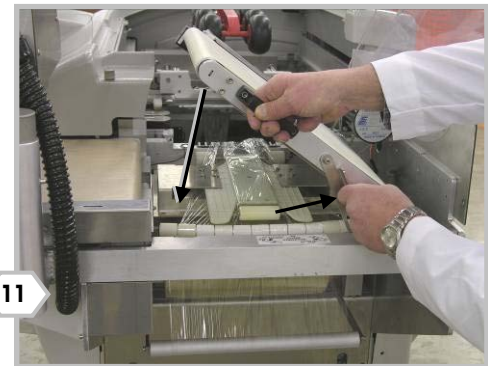

11



12 Make sure you have a firm hold on the handle while lowering the belt.

Close the transfer belt cover.



13



14

From the front of the machine, grab the film and pull it up. Unroll a few feet of film to ensure proper threading.

While continuing to hold the film, close the top cover.



15



16

On the Controller, press the CUT FILM button.

The Controller screen will return to the previous function and the machine is then ready to use.



17



18

After running a few packages, inspect the film where it is gripped by the center clamp. The film must be centered in the clamp.

If not, move the film roll on the bobbin. Re-thread the film if necessary.

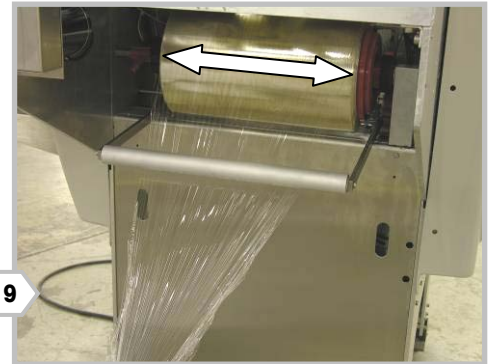

19

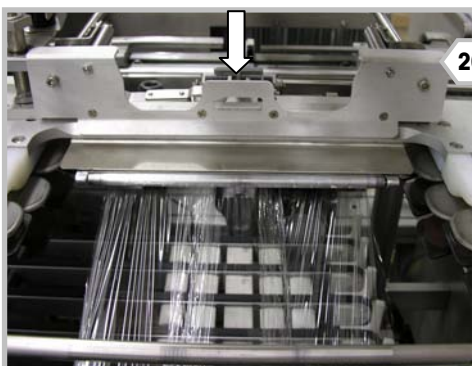

20

Release the film from the center clamp by pressing down on the release lever. Return to step 14.

METTLER TOLEDO

For your notes

4

Trays

Loading the Trays



The Commander wrapper is designed to wrap product contained in standard food trays, designed for automatic wrapping. A variety of standard foam and recycled fiber trays have been tested and proven to work on the Commander wrapper. For questions on trays, contact Mettler Toledo.

If the dimensions of the tray exceed the maximum allowed by the machine, the machine will stop and reject the tray.

1. Trays must be sufficiently rigid and the item must be contained completely within the dimensions of the tray.
2. Place the tray on the Infeed Belt against the black guide on the right side to start the machine.
3. Proper placement is when the red LED dot (A) appears on the upper right hand corner of the tray. Simultaneously, a short beep will sound when placement is correct.



A



4. The tray must pass through the photoeyes before the next package can be placed and weighed. Allow belts to stop before placing the next tray.

Tray Specifications

All products must be completely contained in the trays. If a product overhangs the tray damage can occur and the machine will not be able to properly wrap the product.

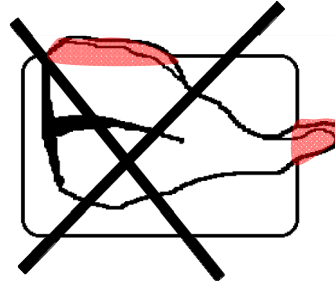

The trays must also be stiff enough to support the product properly. No water or liquid can be in the tray.

The tray dimensions used by the Commander must fall within the following limits. When the Commander is set up for 11 inch film, 10x14 trays are too large for the film and cannot be used.

Tray Specifications with 13" and 11" Film

13" Film	Minimum		Maximum	
	(mm)	(in)	(mm)	(in)
L	120	4.7	400	15.8
W	130	5.1	273	10.7
H	12	0.5	127	5.0

11" Film	Minimum		Maximum	
	(mm)	(in)	(mm)	(in)
L	120	4.7	400	15.8
W	115	4.5	235	9.3
H	12	0.5	102	4

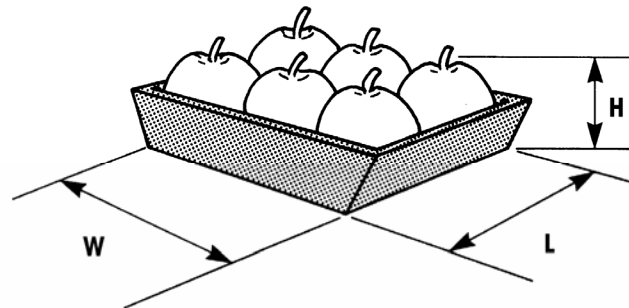

Maximum allowable dimensions will be less when using the machine with 11 inch film. Some trays will require loading a certain way, landscape or portrait. Refer to the following tray loading reference tables for 11 inch and 13 inch machines on the following pages.

Tray Reference Chart – 11" Film

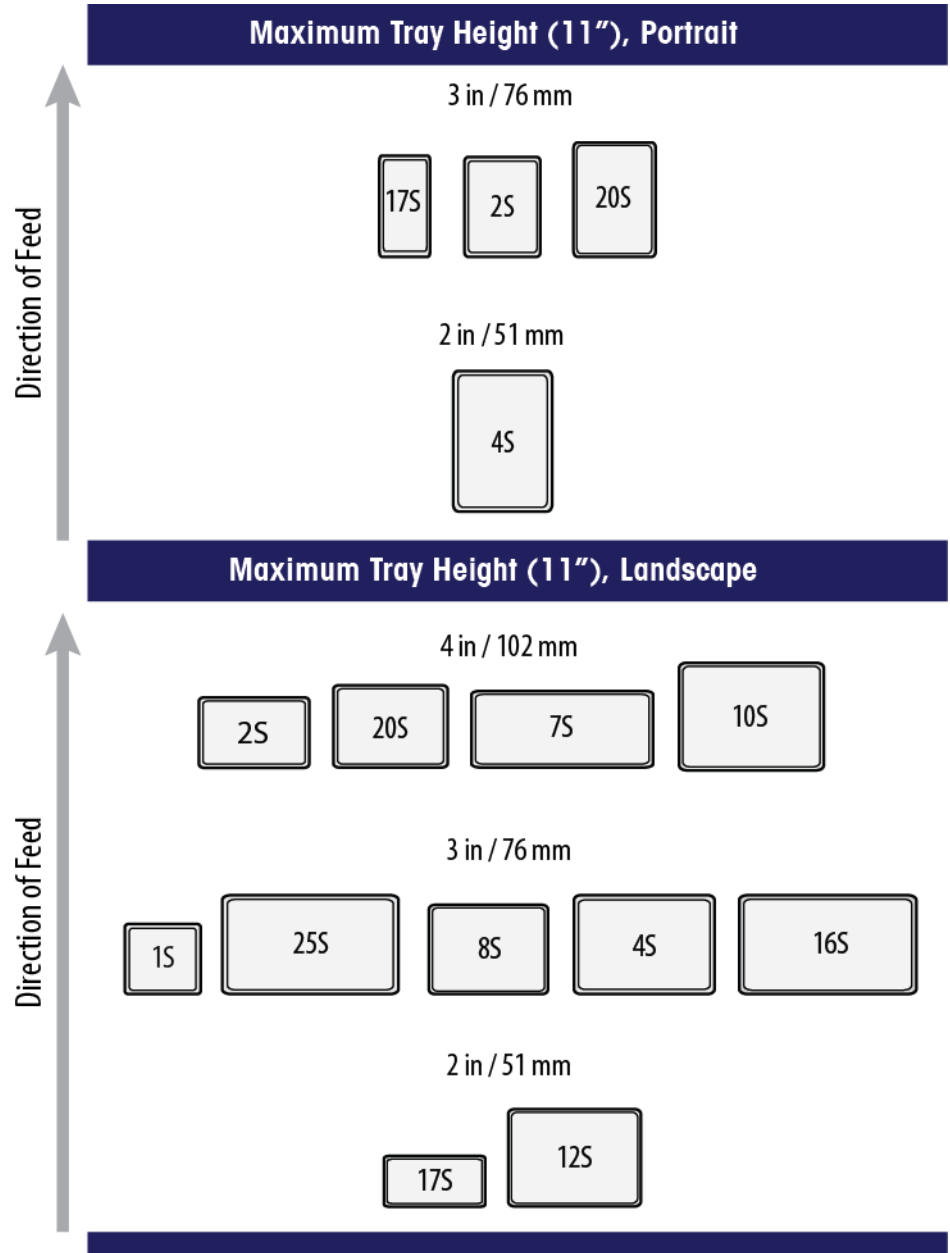

Tray Reference Chart – 13" Film

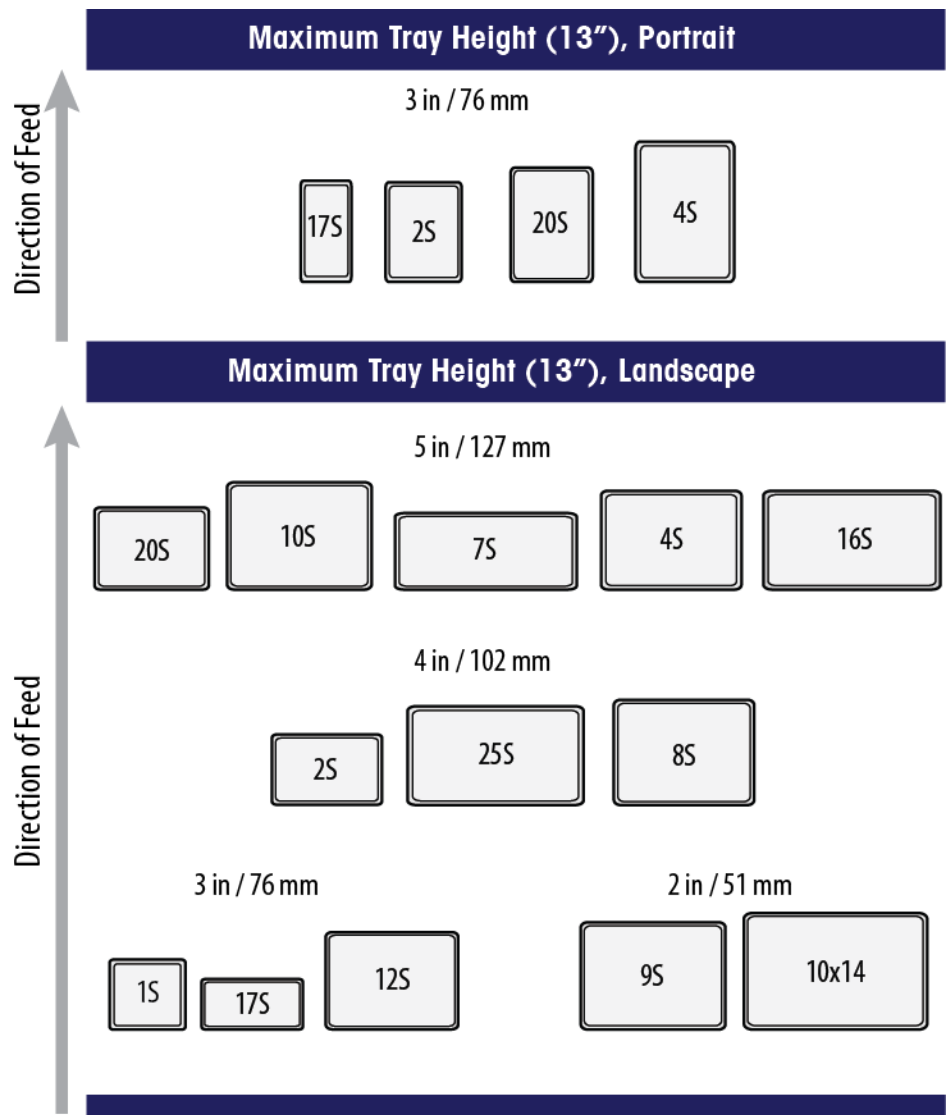

5

Printers

Introduction

Thermal label printers on the Commander have a large label capacity and are designed to print labels containing human-readable information, bar code symbols, and graphics. Your system may have up to three printers installed, a Model 317 Price Label Printer/Applicator, a Model 317 DayGlo Label Printer/Applicator, and a Model 710 Bottom Printer/Applicator.

- The Model 317 price label applicator can apply 2.63 in. (67mm) wide labels with lengths from 2.1 in. (53mm) to 4.2 in. (106mm).
- The Model 317 DayGlo label applicator can apply 1.56 in. (40mm) wide labels with lengths from 0.9 in. (23mm) to 1.5 in. (38mm).
- The Model 710 Bottom Printer can print and apply labels from 2.4" minimum to 4.2" maximum lengths, up to 3" Wide.
- The label print width range is from 1.57 in. (40mm) to 3.14 in. (80mm).



Loading Labels - 317



The power can be left ON when changing labels on the 317 printer. Some systems have two printers installed. If your system has two 317 printers, the process of changing labels is the same on both printers.

Note: Mettler-Toledo recommends cleaning the printer mechanism with every label change.

For reference, you can always refer to the loading instructions located below or on the inside of each printer door. The following step-by-step instructions follow along with this diagram.

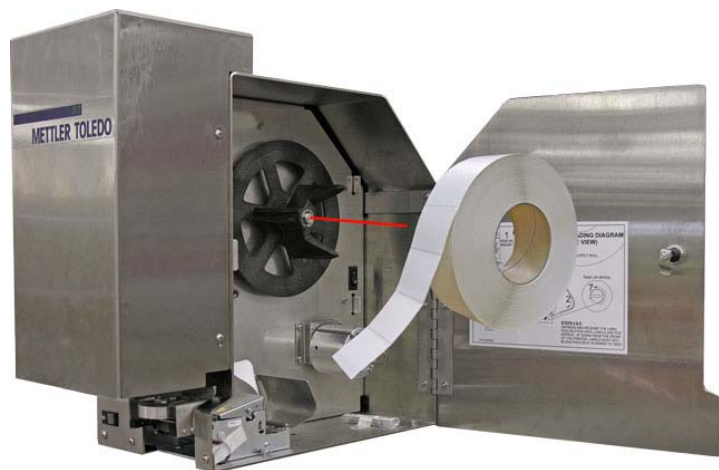
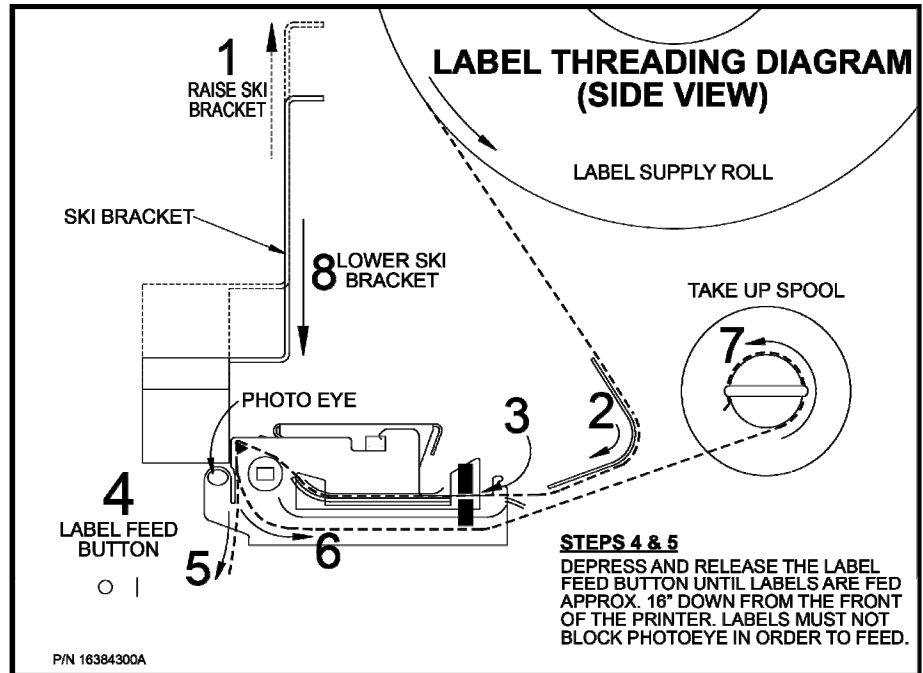

Place the new roll of labels on the Ticket Wheel with the labels unwinding from the top to the front of the printer as shown above.

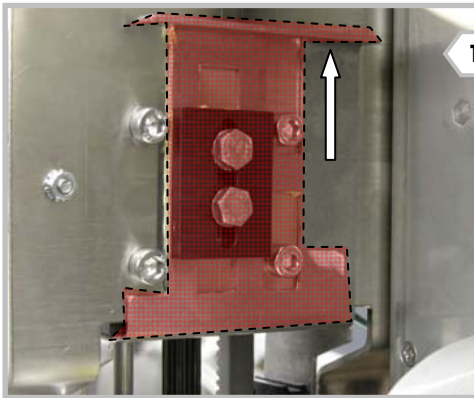

1 Raise the label ski bracket.

Route the labels around the rear guide and into the printer module.

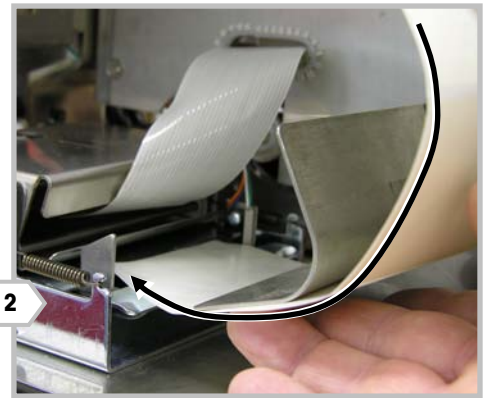

2

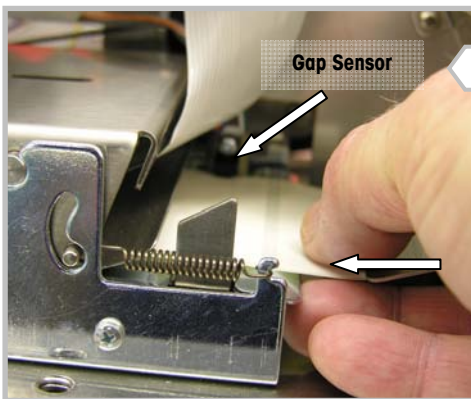

3

Push the labels into the printer until they stop at the rubber platen roller. **Make sure the labels go through the Gap Sensor.**

Press and release the Label Feed button until labels are fed approximately 16 inches straight down from the stripper bar. Note: The labels must not block the photoeye in order to feed through.



4

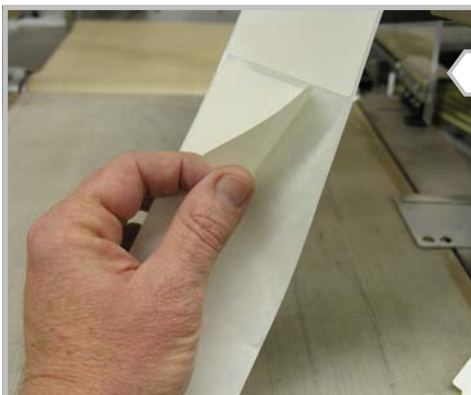

5

Remove the labels from the exposed liner.

Insert the liner into the printer at the bottom.

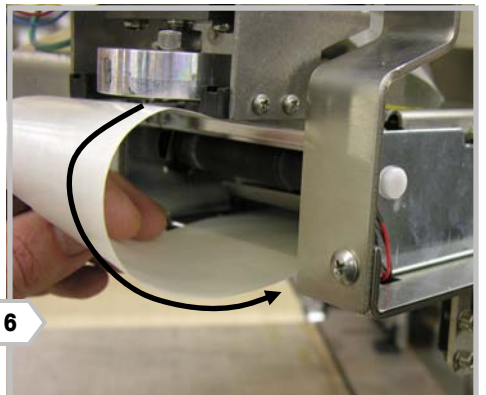

6



7 Remove the liner take-up clip from the take-up spool and wind the liner around the spool and secure with the liner clip.

Lower the Ski Bracket.

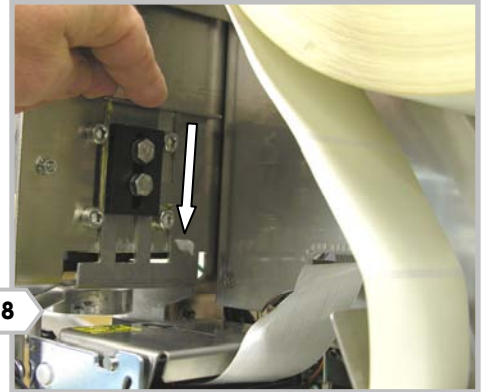

8



9 Correctly threaded labels are shown in the photo to the left.

Close the side cover. Check the Status LED on the front of the printer. Green indicates the printer is ready.



10

Loading Labels – 710

- Open the Access Door for access to the label supply.
- Loading Labels
- Press the label roll onto the supply spool.
- Hold down on the printer latch and slide the printer module to the left.
- Unlatch the printhead by pulling the printhead support first right and down.
- Thread the label liner up as shown with the liner coming off of the roll to the right side.
- Insert the labels into the rear of the printer making sure the labels are fed between the gap sensor.
- Thread the liner up and back into the printhead, then onto the takeup spool. Secure the liner with the locking clip.
- Advance the liner until a label is visible at the eject end of the printhead.
- Latch the printhead and ensure the liner is threaded through the gap sensor.
- Slide the printer forward to until it latches.
- Close the printer door to operate the unit.

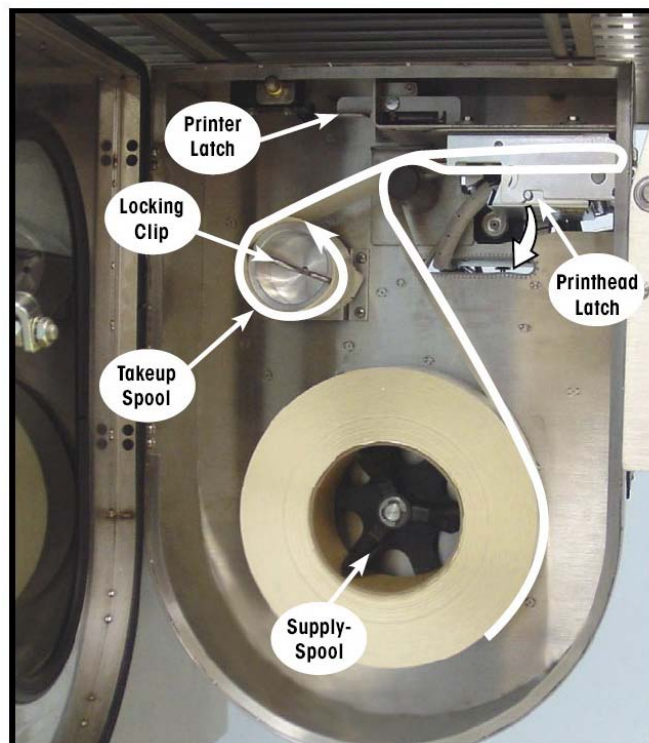

METTLER TOLEDO

For your notes

6

Controller - Touchscreen

Introduction



The Commander Controller features an easy-to-use touchscreen with an easy-to-use user interface. Some examples of the Main and PLU screens are shown below.

Touch to Zero		Tare (lb)	Unit Price	Total Price
3.23 lb		0.00	\$4.59	\$14.83
Gross Zero Cap. 30 x 0.01 lb				

Touch to Zero		Department: Dept: 0		Enter PLU Number	
0.00 lb		Mar 18, 2010 1:56 PM		0	
Gross Zero Cap. 30 x 0.01 lb		Unit ID: UKCW_T_AE			
		Service			

PLU# 8195	PLU# 8196	PLU# 8197	PLU# 8198
BUTCHER TENDERLOIN W	BUTCHER TENDERLOIN U	BUTCHER BNL'S FILLET	BEEF ROUND ROLLED AND T
PLU# 8200	PLU# 8201	PLU# 8202	PLU# 8203
BUTCHER CHUCK ROLL U	BUTCHER ROLL HALF SL	BUTCHER UNDER BLADE	BUTCHER CHUCK STEAK
PLU# 8204	PLU# 8209	PLU# 8210	PLU# 8220
BUTCHER CHUCK STEAK	BUTCHER CHUCK EYE ST	BUTCHER CHUCK EYE RO	BUTCHER SHOULDER CLO
PLU# 8221	PLU# 8222	PLU# 8223	PLU# 8224
BUTCHER SHOULDER ROA	BUTCHER SHOULDER ST	BEEF CHUCK SHOULDER STE	BUTCHER ENGLISH ROAS

Pack Date	Shelf Life	Use By Date
8/26/12	8/29/12	8/30/12

Buttons: Landscape Turn Label, Clear, Options, Help, PRINT, Place Label

Fusion Interface

Touch to Zero		Tare	Unit Price	Total Price
1.03 lb		0.02	\$3.49	\$3.59
Net Capacity 50 x 0.01 lb				

Touch to Zero		Department Dept: 1		Enter PLU Number	
0.00 lb		May 22, 2007 11:41 AM		0	
Gross Zero Capacity 50 x 0.01 lb		Unit ID: Commander-Lab			
		Prepack			

1 CUT CHUCK RO	ARM ROAST ECONOPACK	GROUND ROUND PATTIES	CHUCK EYE ECONOPACK
BTOM ROUNDST	DND PAK BOTI ROUND STEAK	GROUND CHUCK PATTIES	GROUND BEEF
ARM STEAK ECONOPACK	LE CHUCK TEND	CHILI MEAT 85%	CHOPPED SIRLOIN
EYE ROUND ECONOPACK	TIP STEAK ECONOPACK	SWISS STEAK	SWISS STEAK ECONO PAK
CHUCK TENDERS	CHUCK TENDER ECONOPACK	GROUND BEEF 73%	BEEF STEAKETTES
SIRLOIN SIZZLER	CHUCK ROAST	R. ROAST ECONO	ROUND STEAK

Pack Date	Shelf Life	Use By Date
5/22/07	5/24/07	5/27/07

Buttons: Landscape Turn Label, Clear, Options, Help, PRINT, Place Label, Bottom Label

Classic Interface

The Commander controller can be configured to display in either a Classic or Fusion interface. All functions and options are available in both interfaces.

For further details on changing the controller interface, see the UC Line Software Technical Manual (B16588100A) or contact your system administrator.

Main Screen



1	Weight Display. Touch to zero the scale.
2	Current Department, date, time, and network ID.
3	Price Look Up (PLU) number display.
4	CLEAR button clears values from the display.
5	ENTER accepts the displayed value.
6	BACKSPACE erases the last entry. When pressed again it erases digits to the left.
7	Search the Database for a PLU based on alpha-numeric input from the operator.
8	The Operations button is used to access additional functions such as Cutting Test and Void Transactions, Measure Label, and Reset Printer. In software versions 4.1 HF6 or later, the Alternate language button located on the screen can be used to switch languages to the Alternate Language configured in setup.
9	Wrapper accesses settings for the wrapper such as film tension and belt temperature. This button will appear RED if there is an error in the wrapping unit.
10	Help will appear on certain screens.
11	The Setup button is used to enter the controller's Setup Mode.
12	Preset Page Selector buttons. When there are more buttons than can be displayed on the screen, use the arrow left or right buttons to display more of the pages. The current page will be highlighted. These buttons are configured in Setup mode in Presets Setup.
13	Preset Buttons are used for one-touch call up of PLU records. A PLU number can be assigned to a certain key. When this key is pressed, it calls up the record assigned to it.
14	SciF Apps – if enabled other applications are accessed here.
15	Printer Online/Offline and Database Online/Offline indicators. Software Version 4.2 and later has indicators for LDB (L=Data Label Printer, D=DayGlo Printer, B=Bottom Printer). Green=Online, Red=Offline.
16	Alert box. If enabled, any alerts or messages will display here.
17	Gross/Net indicator. When Net displays, this indicates a tare weight.

PLU Screen

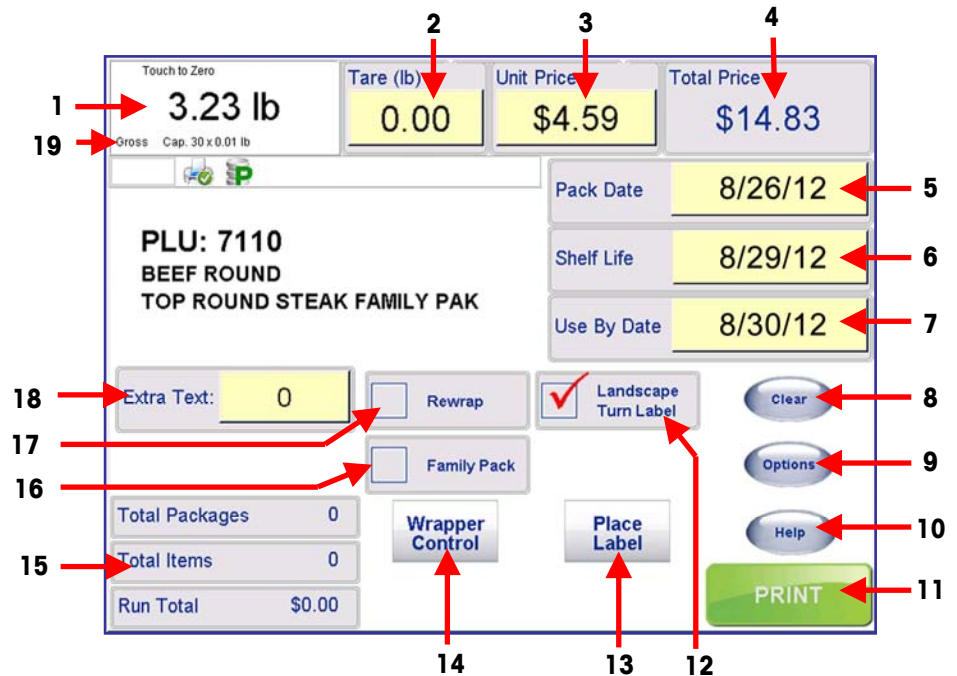

1	Weight of the item (less the tare) if the PLU is sold by weight.
2	Tare is programmed into the PLU record. Touch to override the tare, if allowed in setup.
3	Unit Price is programmed into the PLU record. Touch to override (if allowed in setup).
4	Total Price of the item. When sold by weight, this is the unit price multiplied by the weight of the item. Total Price is never operator accessible.
5	Pack Date uses the current date set in the controller. This will print on the label if it is included in the label format.
6	Shelf Life is programmed into the PLU record. This date is used to show the date when the item should not be sold anymore. This date will print on the label if it is included in the label format. When the box is white, this date can be changed.
7	Use By Date is calculated based on the current Pack Date. The item should not be consumed beyond this date. This date will print on the label if it is included in the label format. When the box is a light background, this date can be changed.
8	Clear ends the transaction and returns the display to the Main Screen.
9	The Options button is used for temporary overrides to change various settings.
10	Help will appear on certain screens. When touched, this button will launch the Help system.
11	Print - prints the item label.
12	Landscape/Turn Label allows the user to modify the label's orientation.
13	Place Label selects the location and orientation that the label will be placed on the package.
14	Wrapper Control takes you to the Wrapper Control screen where you can modify various settings of the wrapper itself, such as the tension and temperature of the film.
15	Total Packages, Total Weight, Run Total show any accumulated totals for the current run.
16	Family Pack is a macro that is setup to reduce the price when sold in larger quantities.
17	Rewrap flags the transaction as an item previously weighed and pulled from the case.
18	The Extra Text number is programmed into the PLU record so when the PLU is called, the associated Extra Text is called. When the box is white, this can be changed.
19	Gross/Net indicator: When Net displays, this indicates a tare weight.

Options Button

The **Options** button on the **PLU Screen** is used for the following temporary overrides. Some items may not allow an override, depending on the system configuration.

The screenshot shows a control panel with several sections:

- Label Format:** A dropdown menu set to "1_9" U BW Sell BCB".
- Grade:** A dropdown menu set to "4: Grade#4".
- Bottom Label Format:** A dropdown menu set to "NONE".
- Satellite Graphic:** A dropdown menu set to "None".
- Linked Graphic:** A dropdown menu set to "0: linked_graphic".
- DayGlo Graphic:** A dropdown menu set to "0: dayglo_graphic".
- Run Total:** A section with three rows:
 - Packages: 0, with a right-pointing arrow and "SubTotal" label.
 - Weight: 0.00, with a right-pointing arrow and "Total" label.
 - Total: \$0.00, with a right-pointing arrow and "CountDown" label.
- Accumulator:** A dropdown menu set to "None".
- Print Inhibits:** A right-pointing arrow.
- Buttons:** "Help" and "Return" buttons at the bottom right.

The overrides can be enabled or disabled from the **Transaction Screen Overrides** screen in the **Service Scale Setup**, as shown below. In order to allow the overrides, the boxes must be checked.

Label Format

An alternate label format can be selected for this run using this override.

Grade

You can select another Grade for this run using the drop down menu.

Bottom Label Format

If configured, this is used to apply a bottom label to every package when used in an automatic system with a bottom label applicator.

Satellite Graphic

If a Satellite Graphic is configured on the label, you can use this to override the graphic used for this run, or disable it for this run.

Linked Graphic

If a linked graphic is configured on the label and in the PLU record, this can be used to select another for this run.

DayGlo Graphic

If there is a DayGlo printer used, the programmed graphic can be changed for this run. Select from a drop down list or using the Keypad enter the graphic's corresponding number.

Accumulator

A different accumulator for the totals information can be selected using this function.

Run Total

Totals from the selected PLU's current run are gathered based on weight, cost, and number of packages. These are displayed on the PLU Edit Screen. They can be printed on a "Run Totals" label if needed. In order to print the Run Totals label, the format must be set up from in the Label Printer Setup screens.

Print Inhibits

Select the **Print Inhibits** button from the Options screen to select what items not to print on a label for this transaction. When checked, the item will not print on the label.

When the field is checked, it will not print on the label.

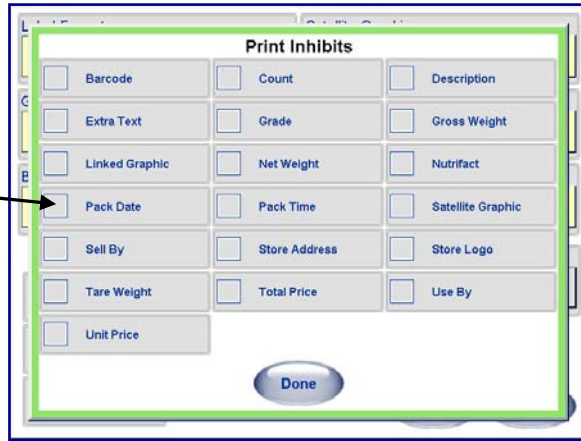

Tare Selector

If the tare is forced or when the tare field is pressed, you will be presented with a tare selector window. You can over-ride the tare by entering the value, by placing the package material on the platter and pressing Platter Tare, or by pressing the graphical tare images (version 4.2 and later). Graphical Tare is enabled in Setup/Scale Settings.



Graphical Tare Selector

Place Label Button

Note: When the printer is in "Wrap Only" or "Manual" mode the "Place Label" button on the PLU screen turns gray and the text is replaced by the Mode you are in.



At this point, the button cannot be selected because label placement is not required when the wrapper is in Wrap Only or Manual Mode.

Selecting the **Place Label** button on the PLU screen will bring up the Label Placement screen.

From this screen you can graphically select where on a package the final label will be placed as well as the orientation of the label.

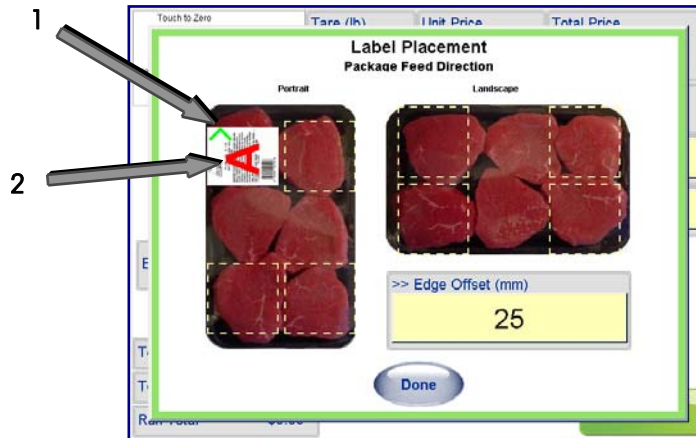

The green arrow (1) shows the edge of the package the offset is applied to. The red letter **A** (2) indicates the orientation of the label graphics.

You can select a landscape or portrait package orientation. Then click on one of the squares to assign where the label will be applied. A label will appear when the box is pressed and by pressing the box again, it will rotate the label 90° with each press.

Note: Depending on which label orientation has been selected, the 317 printer(s) may need to be manually positioned when changing from landscape to portrait modes.

Once label placement has been selected, if a package is going to be inserted Landscape rather than Portrait checking the **Turn Label button** on the PLU screen will adjust label placement accordingly. The label will be placed in the location regardless of package orientation.

Edge Offset

Edge Offset shows the numeric value of where the label will begin from the edge of the package. Default is 25.

PLU Pricing Modes

PLU is an abbreviation for Price Look Up. The PLU is a reference number assigned to access a product's record that includes fields such as the description, price, tare, etc. Different PLU's will have different pricing modes. Meat is normally sold "By Weight" by the pound or kilogram. Many bakery products are sold "By Count". Other products may be sold in a standard package that all weighs the same (or assumes all weight is the same or a minimum value). The different pricing modes are as follows:

By-Weight PLU

Examples of products sold by weight are meats, cheese, poultry, and produce. By-Weight items can be priced in three ways:

- Priced "Per Pound" or "Per kg" - Typically weighed items are priced by lb or kg. The weight multiplied by the unit price equals the total price of the product to the customer.
- Priced "Per Fraction of a Pound" or "Per Fraction of a KG" (fractional) - The item may also be priced by the fraction of the lb or kg (where legal and desired). Pricing per 1/4 pound/kg and per 1/2 pound/kg are available.
- "Pounds for" or "KG for" price - The PLU may be sold using a price mode of a certain amount of weight for a fixed value. (ex: 2 pounds for \$1.00).

By-Count PLU

Examples of items normally sold by the count are cookies, donuts, rolls, bread, etc. Example: 4 Apples for \$1.69. The By-Count PLU allows the operator to use the wrapper for a labeling operation. Pricing is entered as a certain quantity of items for a set price. If the total weight for the items is needed, a weight field can be configured on the label to print the weight of the items in addition to the By-Count information.

Standard Pack PLU

Examples of items normally sold by Standard Pack include whole chickens, sheet cakes, bread, etc. The Standard Pack PLU is similar to By-Count and also allows the operator to use the wrapper for a labeling operation. The labels indicate the net weight of the item and total price of the item. These types of items all weigh the same (or are assumed to weigh the same or of a minimum value).

PLU Search Modes

The **Search** function allows searching for a PLU by name or partial name. This is helpful if the PLU number is unknown or if a list of choices is desired. At the **Main Screen**, click on the **Search** button.

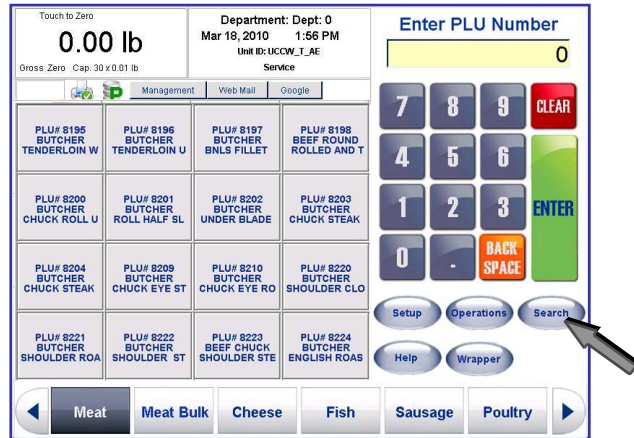

From here, the Search screen will appear. Select the **Department** from the dropdown menu (1). Then using the keyboard (2) type in the word, or portion of the word, you are looking for and press the **Search** button (3). The returned search list is browsed via a scroll bar.

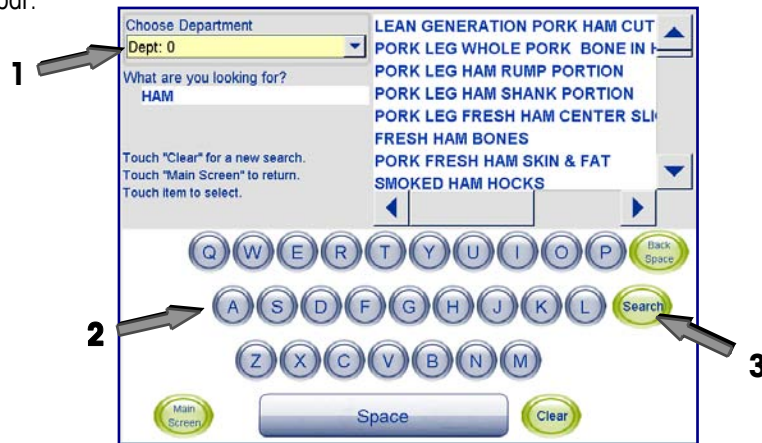

This will return a list of any PLU in the database containing that word as part of a keyword or description. Highlight the PLU by touching it. This will load the PLU into the **PLU Screen**.

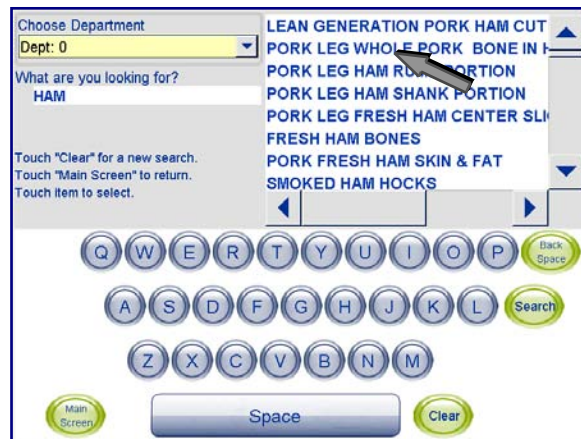

Country of Origin Labeling (COOL)

Country of Origin Labeling (COOL) is information assigned to a specific PLU that designates where a product came from and the processing it went through.

If a COOL is associated with a PLU, you will be prompted to choose a preconfigured COOL statement or, in some cases, create custom COOL statements prior to going on to the PLU screen.

COOL associations are set up from the UC Editor. For more information on the COOL setup procedure see the **UC Line Software Technical Manual**.

Preconfigured COOL Statements

If a PLU is selected that has a forced COOL statement, the **Preconfigured COOL Declaration** screen will appear. The Preconfigured COOL Declaration screen consists of:

Current COOL Text (1) – will display current text in use.

Default COOL Text (2) – will display the programmed default COOL text which will be printed on the label.

Most Recently Used Text (3) – the COOL text statement that was last used on a transaction.

List (4) of possible preconfigured text that can be applied to the selected PLU.

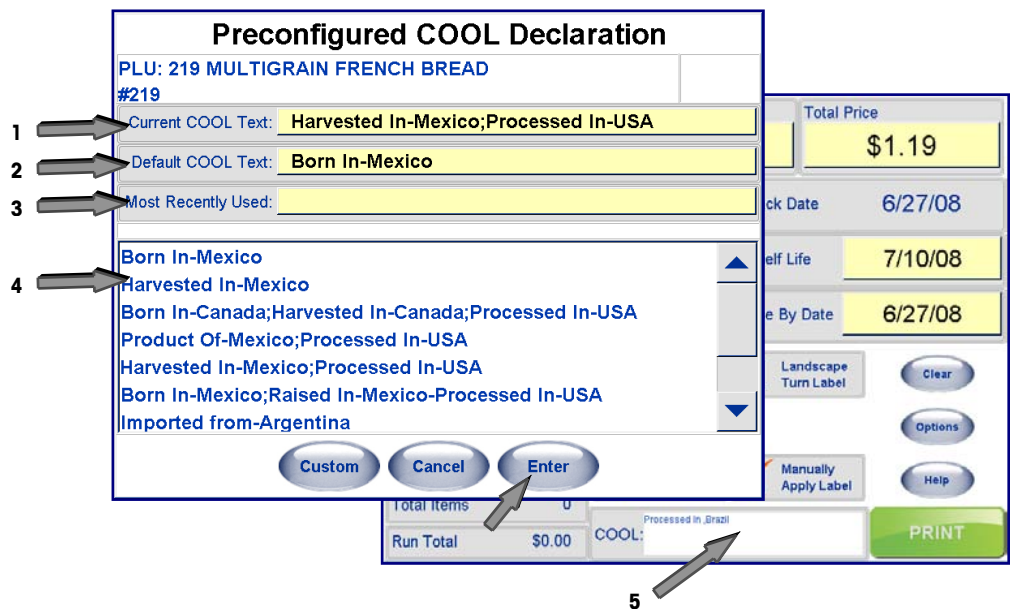

After selecting the text you wish to use, press **Enter**. You will continue onto the PLU screen, where the COOL text area will be displayed (5).

If a COOL statement is configured, but it is not "forced" (meaning you are able to complete a transaction without selecting a COOL statement to be printed on the label), a **No COOL** button is available.

Select **No COOL** if you wish to complete the transaction and have the label printed without any COOL statement.

Preconfigured COOL Declaration
PLU: 219 MULTIGRAIN FRENCH BREAD
#219
Current COOL Text: **Harvested In-Mexico;Processed In-USA**
Default COOL Text: **Born In-Mexico**
Most Recently Used:
Born In-Mexico
Harvested In-Mexico
Born In-Canada;Harvested In-Canada;Processed In-USA
Product Of-Mexico;Processed In-USA
Harvested In-Mexico;Processed In-USA
Born In-Mexico;Raised In-Mexico-Processed In-USA
Imported from-Argentina
No Cool Custom Cancel Enter

This PLU does not have COOL Statements Enforced, so a transaction can proceed without a COOL statement by using **No COOL**.

Preconfigured COOL Declaration
PLU: 219 MULTIGRAIN FRENCH BREAD
#219
Current COOL Text: **Harvested In-Mexico;Processed In-USA**
Default COOL Text: **Born In-Mexico**
Most Recently Used:
Born In-Mexico
Harvested In-Mexico
Born In-Canada;Harvested In-Canada;Processed In-USA
Product Of-Mexico;Processed In-USA
Harvested In-Mexico;Processed In-USA
Born In-Mexico;Raised In-Mexico-Processed In-USA
Imported from-Argentina
Custom Cancel Enter

This PLU does have COOL Statements Enforced, so a Preconfigured Text or Custom Text must be selected before proceeding.

If the PLU selected has data that will allow the user to construct a custom COOL statement, the **Custom button** is available as well.

Custom COOL Statements

Custom COOL statements are constructed from keywords or production steps and country names. If a PLU record has custom COOL production steps and country names associated with it, a **Custom** button will appear at the bottom of the **Preconfigured COOL Declaration** screen.

Note: If there is no Preconfigured COOL text associated with the PLU, the user will be immediately taken to the Custom COOL dialogs.

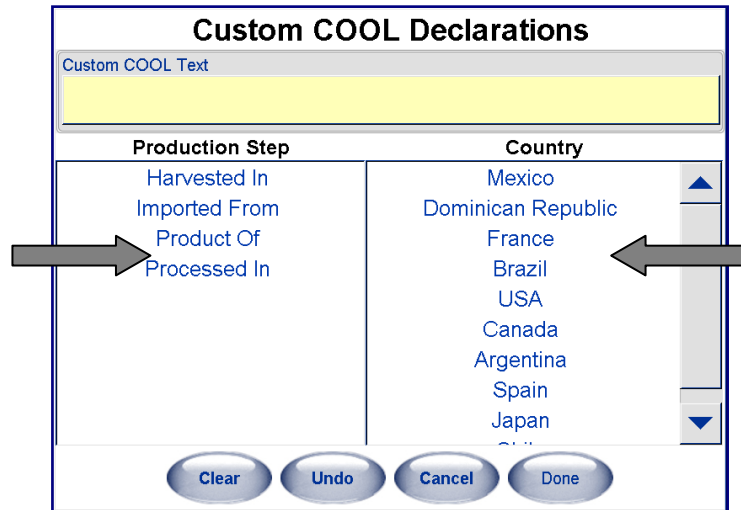

Select a **Production Step (1)** followed by a **Country (2)**. Continue in that fashion until satisfied with the new custom COOL declaration (view in the **Custom COOL Text** field on the top of the screen).

Press the **Done** button when complete.

The **Undo** button will undo the last entry and you may continue to “undo” until all countries and production steps are removed.

The **Clear** button will completely clear the custom declaration allowing a new declaration to be built.

Forced COOL

There is a field that can be set in the PLU record that indicates COOL is to be forced on that PLU. There is also a setting within **Service Scale Setup** that enables forced COOL on all transactions for that unit. When both of these are set, the Commander will not allow a transaction to complete without COOL.

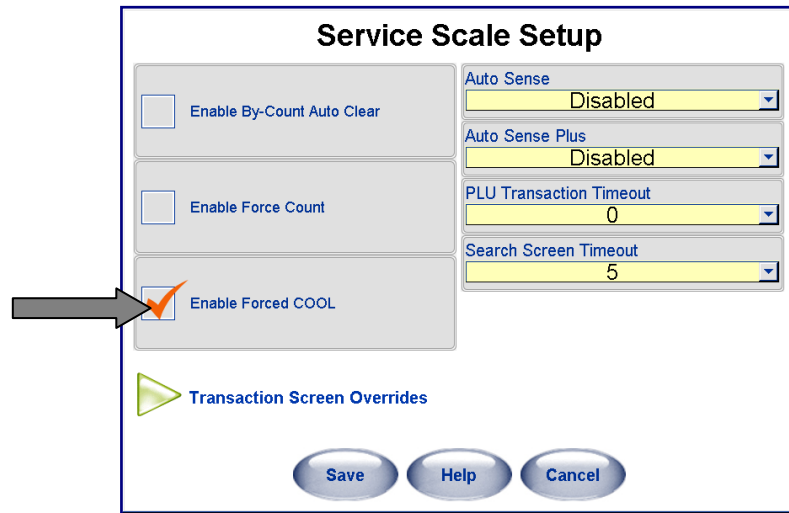

COOL PreText

COOL Pre-Text is a single text record associated with the PLU in the PLU record. It is not changeable and is always printed on the label. A common use of pre-text is to identify if seafood is farm raised or caught in the wild.

Wrapper Control

You can access the Wrapper Control screen two ways: from the main screen by pressing the **Wrapper** button or from the PLU screen by pressing the **Wrapper Control** button.



From the Wrapper Control screen, you can regulate various wrapper settings as well as view error logs.



Mode Buttons

The Commander Wrapper can be set to one of four (4) modes (the active Mode will appear with white text on a dark background):

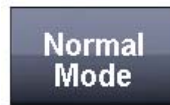

Normal Mode – the package will be weighed, wrapped and labeled.

Manual Mode – Allows manual weighing and labeling. After placing the package on the infeed, a label is printed allowing manual application to the package. Remove the package and repeat for any additional packages. A manual weighing platter is available as an option from Mettler Toledo (shown below).

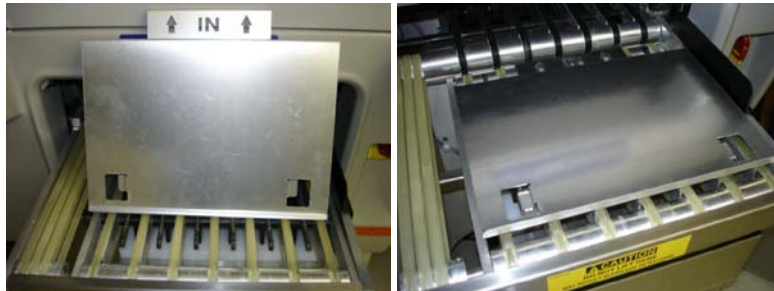

Wrap Only – the package is wrapped only and will not be weighed or labeled.

Pre-Wrapped – the package will not be wrapped and will automatically be weighed and labeled. By selecting this mode it is assumed the package is already wrapped.

Note: If you access the Wrapper Control screen using Wrapper button on the Main screen, all the Mode buttons will appear gray and cannot be selected except for Wrap Only. This is because for any wrapping mode other than "Wrap Only" you need a PLU selected.

Done Button

If you access the Wrapper Control screen by using the Wrapper Control button on the PLU screen, the **Done** button will begin to countdown from 10. If no selection or changes have been made by the 1 count, it will automatically return to the PLU screen. This prevents the wrapper from being left in the Wrapper Control screen while a PLU is active.

The countdown will reset to 10 after **each change made** in the Wrapper Control screen.

Select the **Done** button when you have made your changes or at anytime during the countdown to return to the PLU screen.



Note: the countdown does not occur if you enter from the **Wrapper** button on the Main screen.

Film Setting

Film Setting controls the tension of the film during the wrapping process. This ensures a properly wrapped tray with the least amount of wrinkles. The Film Setting is accessed by pressing the **Wrapper Control** button on the **PLU screen** or the **Wrapper** button on the **Main** screen.



From the Wrapper Control screen, press a Film Setting appropriate to the type of package being wrapped.

1	High Tension	Slightly tighter wrap on certain trays.
3	Normal Tension	Normal (Medium) default tension mode for most products and trays.
5	Low Tension	Less tension for larger trays with height greater than 3 inches, less stable trays, fragile products, or products with sharp edges that may tear the film.

Note: the Commander can use two film sizes, 11" or 13". This is set up at the time of installation. To change the film size, contact your service office.

When a change is made to the Film Tension, the field value background will change color while the wrapper is adjusting to the new setting. The film tension usually adjusts within a few seconds. When ready, the light background will be displayed again. Do not send a package through the wrapper until the background color changes back.



Status

The **Status** field shows the current status of the Commander wrapper. If OK is not displayed check the error logs and if needed contact a service technician.

Convey Package

The **Convey Package** button cycles the transfer and sealing belts, ejecting any packages left on the belts.

Film Temperature

Note: The film may not be properly sealed until the Set Belt Temperature has reached the designated temperature.

If after reaching the selected temperature the film does not seal, increase the temperature. If the film is melting, decrease the temperature.

There are three (3) fields that deal with the temperature of the belt and film.

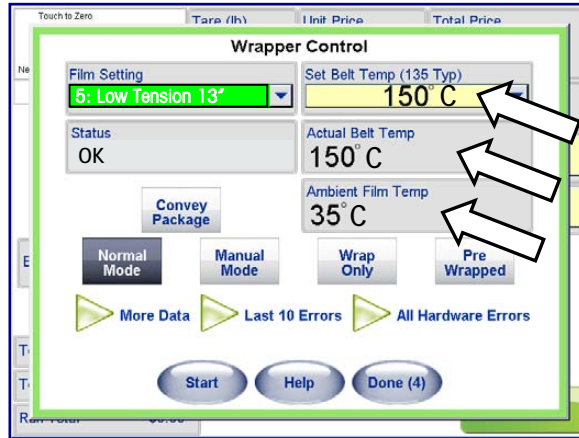

Ambient Film Temp

Ambient Film Temperature lists the temperature near the film roll.

Actual Belt Temp

Actual Belt Temperature lists the temperature of the sealing belt.

Set Belt Temp

From the **Set Belt Temperature** field you can adjust the temperature of the belt by three (3) degrees at a time. Typical temperature is around 135° C for sealing. Select the desired temperature from the drop down list.

If the set temperature is higher than the Actual Belt Temperature, the Actual Belt Temperature field will appear in red until the belt temperature adjusts to the new temperature. If the set temperature is lower than Actual Belt Temperature, the Actual Belt Temperature will appear in blue.

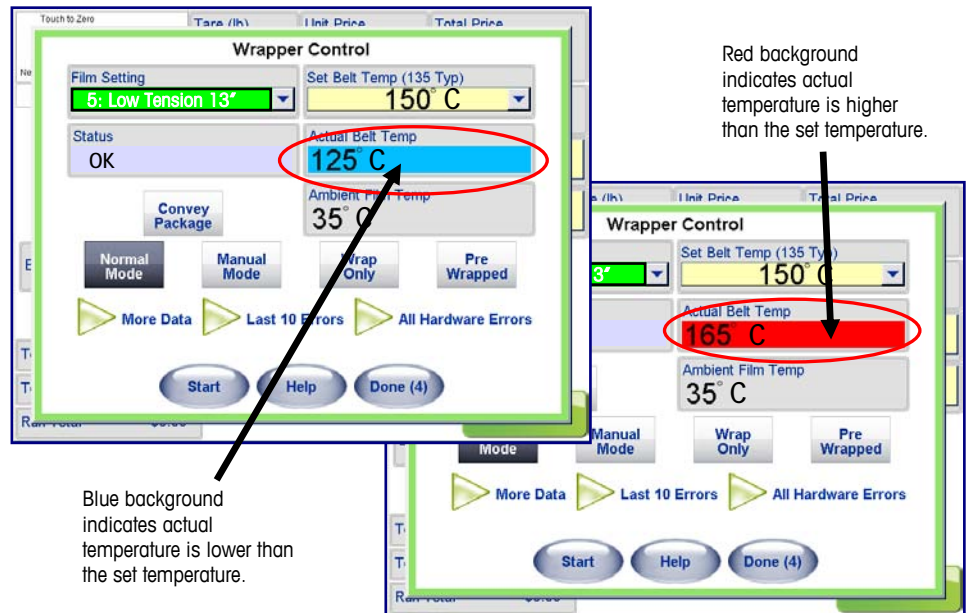

Blue background indicates actual temperature is lower than the set temperature.

Red background indicates actual temperature is higher than the set temperature.

Error Logs

By clicking on **Last 10 Errors** or **All Hardware Errors** a new screen displaying the current error logs will appear. This will either have just the last 10 errors detected by the wrapper or all the errors since the last servicing depending on which error display was selected. For further details see **Chapter 8: Troubleshooting**.

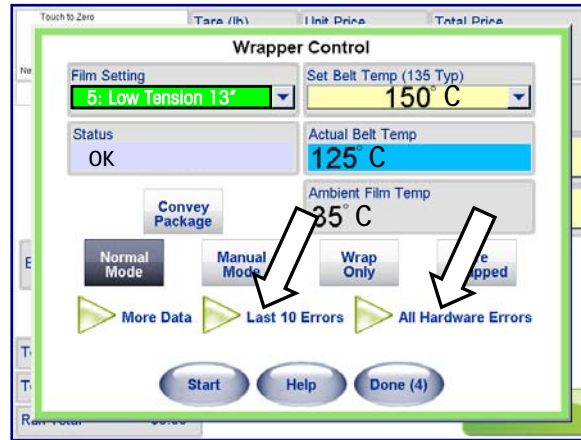

More Data

Clicking on **More Data** will display a screen with additional wrapper information.



Firmware Type

Firmware Type will display the model of the wrapper being used.

Firmware Version

Firmware Version will display the current version of wrapper being used.

Firmware Date

Firmware Date displays the date of release.

Wrapper ID Number

Wrapper ID Number will show the wrapper model identification number. This number will be needed for all service calls.

Side Clamp Stretch Distance

This displays the amount the Side Clamp stretched wrapping the last package.

Center Clamp Run Distance

This displays the amount the Center Clamp pulled the film back wrapping the last package.

Total Packages Wrapped

This field displays the total number of packages wrapped from initial installation. This number cannot be reset.

Packages Wrapped Since Service

The number of packages wrapped since the last date of servicing is displayed. This number is reset by a service technician when the wrapper is serviced.

Packages Wrapped Since Powerup

The number of packages wrapped since last time the wrapper was powered up. This number resets to zero (0) every time the wrapper is shut off.

Package Height

Package Height displays the detected height of the last package wrapped.

Package Width

Package Width displays the detected width of the last package wrapped.

Package Length

Package Length displays the the detected length of the last package wrapped.

Refresh

Use the Refresh button to refresh the wrapper information displayed.

Return

Use the Return button to return to Wrapper Control.

Operations Menu

When you press the **Operations** button, the Operations screen will display. In this screen you can perform the following functions.

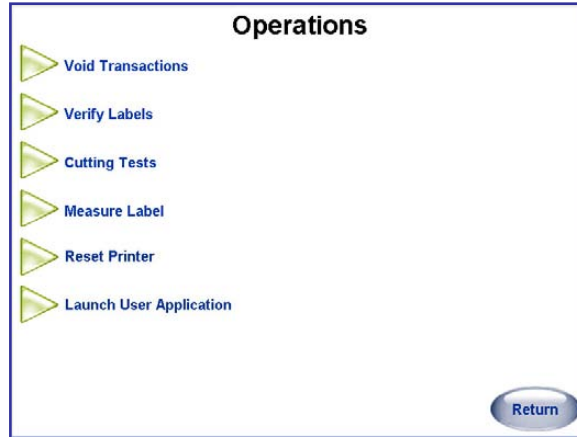

Void Transactions

Use this feature to void previous transactions so your totals collection will remain accurate. Highlight the transaction, and then click the Void button.



A dialog screen will appear to verify voiding the transaction. Click **OK** to confirm.

Verify Labels

This function is used if you wish to print labels of all or selected PLUs. The information printed on the label is determined by the Verify Label Format selected.

Cutting Tests

The Cutting Test allows the operator to enter the primal weight and cost of a product. Data collected during a Cutting Test can be used to produce a report detailing the saleable yield of a primal cut. The operator can enter and exit the test at any time and resume at a later date.

NOTE: the date is entered into the test only when the PRINT key is touched.

The Bone and Fat items run at zero price will appear below the saleable yield line on the report.

To include bone and fat in the tests, the following two By-Weight PLU records should be created:

Bone - Enter unit price as zero, **Fat** - Enter unit price as zero.

The controller will recognize the zero price non-saleable items and will split them from the saleable items on the report. A third By-Weight PLU for miscellaneous trimmings can also be created and included in the test.

After all of the items have been entered in the cutting test, everything should be weighed and a label printed for each PLU. The test is complete when all items from the test product are run.

Measure Label

Measure Label is used to verify and reset the label size that is currently in the printer. Be prepared to catch the labels as the printer feeds them while it is determining the size.

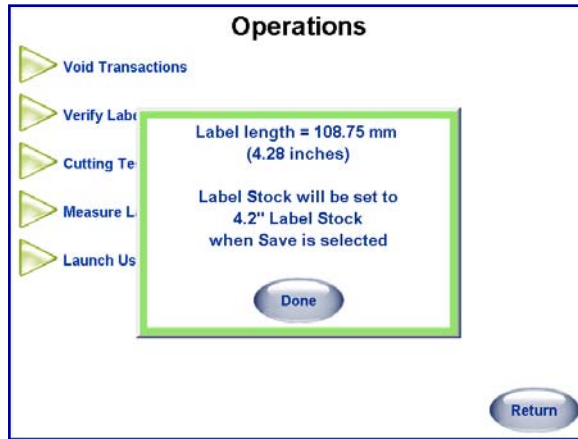

Reset Printer

The Reset Printer button will reset all attached printers. This can be used to recover from a communication error or other types of errors where a printer will not reset automatically. (Software Version 4.2 HF5 or later).

For versions prior to 4.2, this function is accessed through Unit Setup, Serial Devices Setup, by pressing the Refresh button.

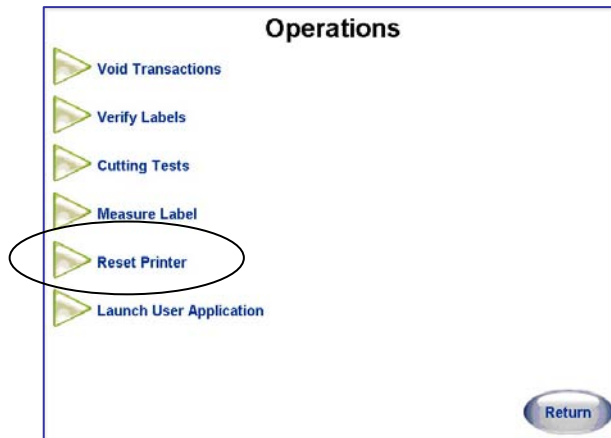

Setup

The Controller's Setup screens are accessed by pressing the **Setup** button on the Main screen. The Setup screen is shown below. To return to the Main screen, press the **Return** button. Touch the other buttons to enter into the desired setup topics.

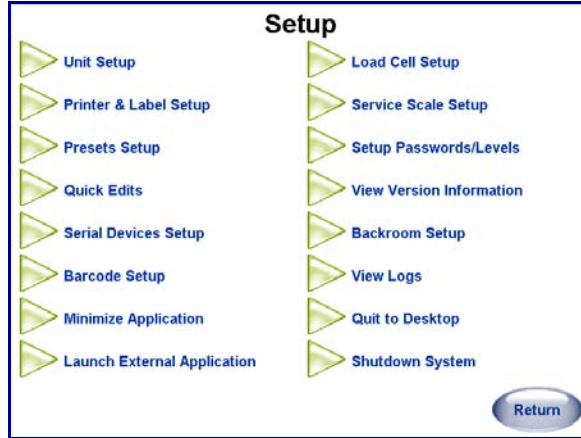

The following sections detail common functions available to the operator on the Setup screen. Your particular unit may be configured differently than outlined in this chapter. A password may be required to access setup so not all setup features may be available to you. Refer to the UC Line Software Technical Manual for additional information.

Unit Setup

Unit Setup is used to select the default department, configure Special Price settings, customize the screens, and select other special options. The Unit Setup screen is shown below.

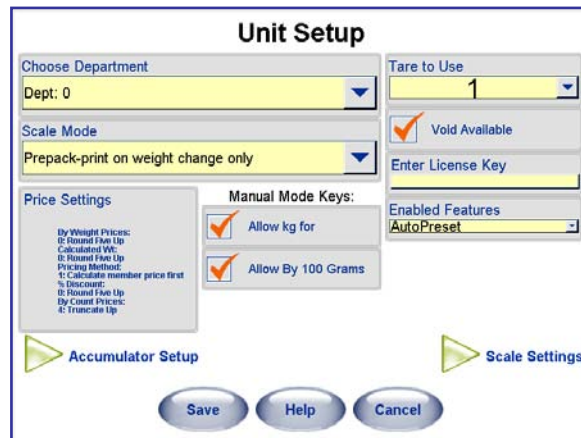

Choose Department

This is the "home" department where this wrapper will be used. PLUs called from the numeric keypad will be from this department.

Scale Mode

Select from the following modes of operation:

- PrePack – Print on weight change only. Label will issue whenever an item is placed on the infeed table only.
- PrePack – Print by weight change or print key. Label will issue whenever an item is placed on the infeed or anytime the Print button is pressed.

Price Settings

You will be asked to press the calibration switch before you will be allowed to make changes in this area. The calibration switch may be protected by a Weights and Measures Seal. If this seal is broken, the unit may require certification again before use.

This selection defines the rules for rounding weight calculations, unit price, count, and discounts.

- By Weight Prices: Select Rounding Method 0-4 below.
- By Weight Pricing Method: 0: Calculate Savings First and 1: Calculate Member Price First. When selecting "0", the dollars/cents saved value is calculated first, and then the member total price is calculated. When selecting "1", the member total price is calculated first, and then the dollars/cents saved value is calculated. The calculations apply only for the \$/cents off the unit price for a By-Weight PLU.
- By Weight Calculated Weight: Select Rounding Method 0-4 below.
- Percentage Discount: Select Rounding Method 0-4 below.
- By Count Prices: Select Rounding Method 0-4 below

Rounding Methods 0-4

0: FIVE UP (2.5350 ROUNDS TO 2.54)

1: FIVE DOWN (2.5350 ROUNDS TO 2.53)

2: IEEE ROUNDING (EVEN) (2.5350 ROUNDS TO 2.54, and 2.5450 ROUNDS TO 2.54)

3: TRUNCATE DOWN (2.5374 ROUNDS TO 2.53)

4: TRUNCATE UP (2.5315 ROUNDS TO 2.54)

Manual Mode Keys

A manual transaction allows the operator to manually price and label items if the unit is offline from the database.

Allow Lbs for

Checking this box will allow this pricing mode during a manual transaction. Example: The price could be set at 5 pounds for \$4.00.

Allow By Qtr Pound

Some locations allow pricing by quarter pound. If this is legal in your area, you can check the box to enable this pricing mode during a manual transaction. When this is allowed, pricing at \$1.00 per quarter pound is equivalent to \$4.00 per pound.

Allow By Half Pound

Some locations allow pricing by half pound. If this is legal in your area, you can check the box to enable this pricing mode during a manual transaction. When this is allowed pricing at \$1.00 per half pound is equivalent to \$2.00 per pound.

Tare to Use

Select Tare 1 or Tare 2 fields to use as the default tare for this unit.

Accumulators Setup

Accumulators allow you to label a transaction as a specific type to allow for better tracking of totals. This screen is used to select which accumulators to use, to **Rename** the user accumulators, and to **Set the Symbol** that will print on the label when a user accumulator is selected by the operator.

The "Rewrap(R)" and "Inventory(I)" are predefined and cannot be edited. However, you can define three custom accumulators. When these accumulators are used, the symbol in parentheses will print on the label as a flag. When creating custom labels, these fields must be configured on the label. In addition, three custom accumulators can be defined and the symbol used to flag these accumulators on the label and in the database selected using the QWERTY keyboard (**Set Symbol**).

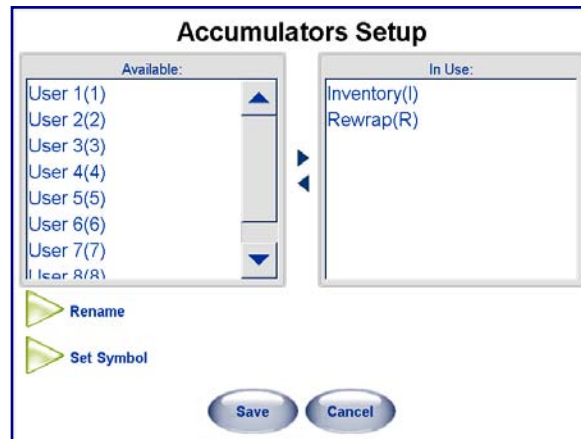

Void Available

If you wish to allow the operator to void a previous transaction, check this box. Leaving the box unchecked does not allow voids by the operator.

Scale Settings

The Scale Settings button has multiple pages of settings for the scale application. These settings can change the operation of the unit and should be set up only by a technician or supervisor. Refer to the UC Line Software Technical Manual for details on this section.

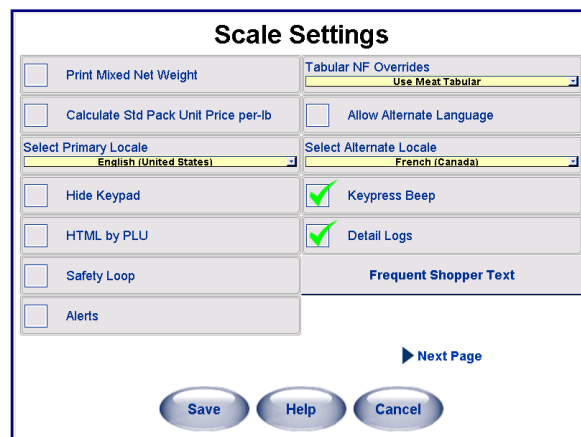

Printer & Label Setup

This screen is used to configure system printers, print verification labels, and to set up the bar codes printed by the printers.

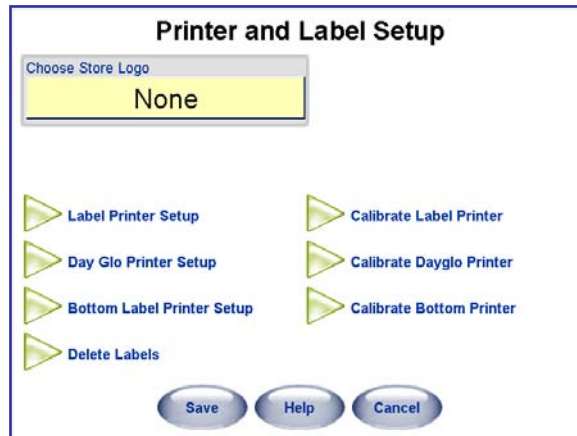

Choose Store Logo

Select the graphic (or none) that will print on all labels that have a store logo field defined.

Label Printer Setup

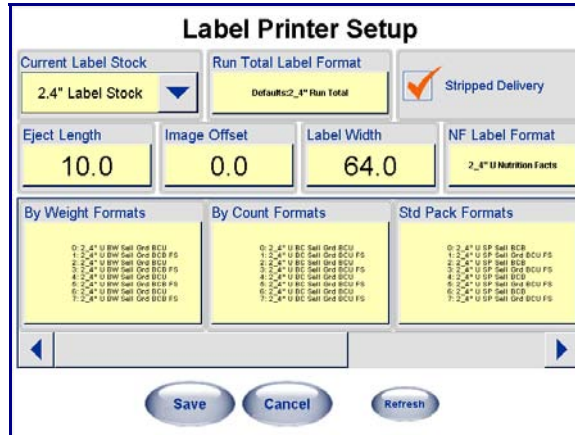

Current Label Stock

The size of the labels listed must match the size of the labels that you will be using in the data label printer **“Printer 1”** (the data label printer). Standard sizes that can be applied automatically include: 2.1”, 2.4”, 3.3”, 3.7”, and 4.2”.

Eject Length

This is the position the label will stop at after printing. This setting is used primarily with an automatic applicator to compensate for variances in printers and labels. For example, this setting can be used to make label pickup easier for an automatic labeler by moving the stop position out if the labels are sticking to the liner, or to move the label stop back if they are falling off the liner prematurely. To move the label stop position

farther out from the printer, increase this value. To move the stop position to stop towards the printer, decrease this value. The default is 12.5 mm.

Image Offset

The Image offset is used to adjust the vertical position of the image printed on the label (in millimeters). It is measured in mm from the rear gap sensor to the printer's print head. Increasing the image offset value moves the printed image lower on the label and increasing the value moves the image down on the label. (Default value: 0.0mm)

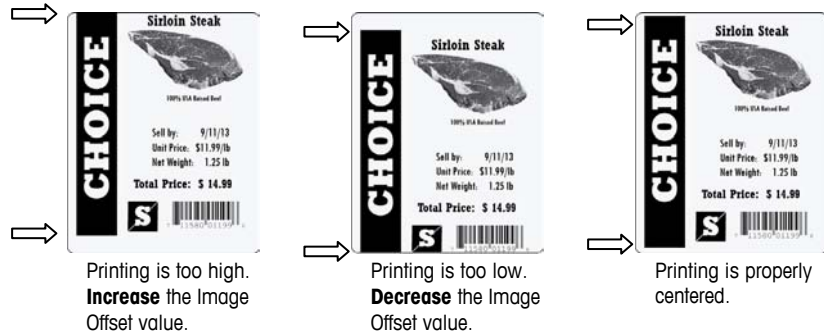

Run Total Label Format

Select the style of the label to use when printing the "Totals" labels.

Label Width

The Label Width (in mm) is used to set the label parameters. The factory default is 64.0 mm.

Stripped Delivery

This box must be checked for automatic application of labels on the Commander wrapper. Stripped delivery means the label is delivered for application stripped from the liner. When this box is checked, the labels will be stripped from the liner and the takeup motor will wind up the used liner on the takeup spool. When this box is not checked, the takeup motor is disabled and the labels are installed to deliver the label and liner.

Inverted Delivery

When enabled (box checked) the label will be delivered with the opposite end first.



NF Label Format

Note: this feature is not available in an automatic system with an indexer as there is no way to apply 2 labels. This entry defines whether a separate NF label will be generated and, if so, what format to use.

Label Formats

By pressing the Label Format field, you enable the selection of prefabricated labels that will suit various fields throughout the interface.

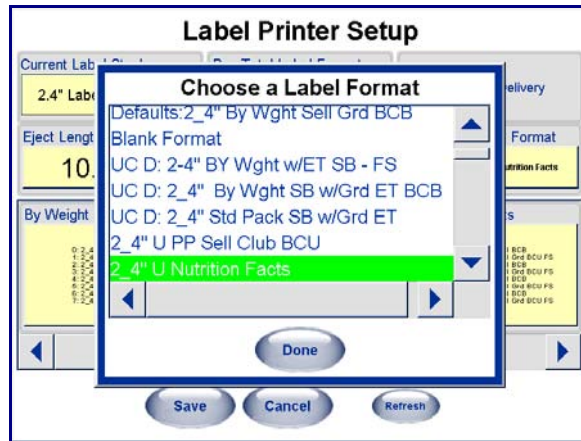

Nuval Label Graphic

The Nuval™ graphic can be printed anywhere on a label. It is positioned on the label by specifying the Nuval™ graphic using SmartLabel V3.0 or higher. The value printed in the graphic is defined in the PLU record by specifying "90" in the Linked Record 11 Type field, and the Linked Record 11 number as the Nuval™ score (range 0-100). If the score is invalid (greater than 100), the graphic will not be printed.



DayGlo Printer Setup

DayGlo Printer

Click in the box to configure the DayGlo printer. Once selected the following options will appear and can be configured.

Current Label Stock

This is the size of the labels you have installed in the DayGlo printer. Currently the only selection is DayGlo labels.

Label Format

This is the format style of the labels in the DayGlo printer. Currently the only selection is for DayGlo graphic. If NONE is selected, no DayGlo Label will be printed.

Stripped Delivery

This box must be checked for automatic application of labels on the Commander wrapper. Stripped delivery means the label is delivered for application stripped from the liner. When this box is checked (stripped mode), the labels will be stripped from the liner and the takeup motor will wind up the used liner on the takeup spool.

When this box is not checked, (unstripped mode), the takeup motor is disabled and the label taken sensor is ignored. In this mode, you could print a batch of labels to be applied at a later time. Continuous stock should always be run with this unchecked (disabled).

Eject Length

This is the position the label will stop at after printing. To have the label stop farther out from the printer, increase this value. The default is 12.5 mm.

Image Offset

The Image Offset (in mm) is used to raise or lower the printed image on the label. The default is 0.0 mm. To raise the image on a label, lower the value. To lower the image on a label, increase the value. For details, refer to Image Offset section in the Label Printer setup.

Manual Mode Enabled

This feature is used when a package is weighed in manual mode. When checked, the Dayglo label will print, but must be manually removed and applied each time a label prints. When unchecked, no DayGlo label will print in manual mode.

Bottom Label Printer Setup

Bottom Label Printer

Click in the box "Bottom Label Printer" to display additional options.

Current Label Stock

This is the size of the labels you have installed in the bottom printer. Available sizes include 2.4", 3.3", 3.7", 4.2", 4.7", and 5.1". When using long labels with narrow trays, the label may hang over the side if it is too wide for the tray.

Eject Length

This is the position the label will stop at after printing. To have the label stop farther out from the printer, increase this value. The default is 13.5 mm.

Image Offset

The Image Offset (in mm) is used to raise or lower the printed image on the label. The default is 0.0 mm. To raise the image on a label, lower the value. To lower the image on a label, increase the value. For details, refer to Image Offset section in the Label Printer setup.

Label Width

This value is the width in millimeters of the current label stock.

Conveyor Speed

The value of inches per second speed should be set to 25.0 for the Commander.

Inverted Delivery

Used when a label stock is wound 180 degrees from the normal winding. The normal delivery is the label will print bottom first. When Inverted Delivery is checked, the top of the label will print first.

Manual Mode Enabled

Used when a package is weighed in manual mode. When checked, the bottom label will print, but must be manually retrieved and applied each time a label prints. In this mode, when a label is printed, the conveyor will start and the operator must either block the photoeye to deliver the label or place the package on the conveyor blocking the photo so it will convey and apply the label. When unchecked, no bottom label will print.

Label Format

This is the format style of the labels in the bottom printer. If NONE is selected, no bottom label will be printed.

Calibrate Printer Gap Sensor

New labels may need to be set up in the printer to work properly by using this function. By selecting **“Calibrate Label Printer”**, **“Calibrate DayGlo Printer”**, or **“Calibrate Bottom Printer”** the gap sensor in the printer can be calibrated if labels are not ejecting properly (multiple labels or partial labels ejected).

After selecting **“Calibrate Label Printer”** or **“Calibrate DayGlo Printer”**, or **“Calibrate Bottom Printer”** press **“Accept”** and catch the ejected calibration test labels.

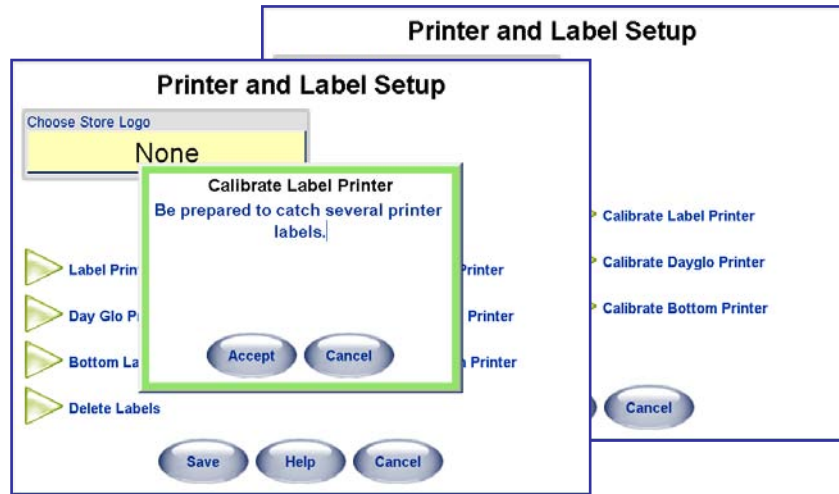

Barcode Setup

Barcodes are configured according to your scanner requirements. See your store IT department and the **UC Software Technical Manual** and **UC Service Manual** for additional information.

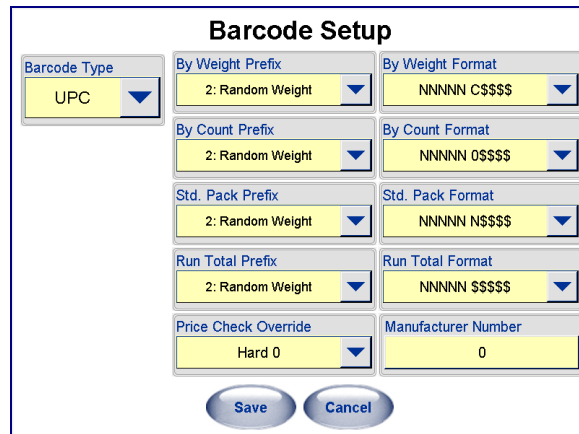

Barcode Type

Select a **Barcode Type** of UPC, EAN-13, EAN-128, or GS1 (Version 4.2 and later) bar code symbols. Only valid settings will display per each bar code type.

UPC Barcode



<p>By-Weight Prefix By-Count Prefix Std. Pack Prefix Run Total Prefix</p>	<p>Select the bar code prefix. This is the bar code type and is the first character of the bar code. The default is 2.</p> <ul style="list-style-type: none"> 0 General Merchandise. (No price is encoded) 1 Not identified. 2 Random-Weight. Item number with total price encoded. 3 National Drug and Health items. Similar to Type-0. 4 In-Store Marking. 5 Coupons. 6 General Merchandise. (No price is encoded) 7 General Merchandise. (No price is encoded) 																								
<p>By-Weight Format By-Count Format Std. Pack Format Run Total Format</p>	<p>Refer to the code explanations.</p> <table border="0"> <tr> <td>NNNNN ##### X</td> <td>(5-D Item/5-D Wgt)</td> <td>Format Codes:</td> </tr> <tr> <td>NNNNN N#### X</td> <td>(6-D Item/4-D Wgt)</td> <td>N Item number Digits.</td> </tr> <tr> <td>NNNNN O#### X</td> <td>(5-D Item/O/4-D Wgt)</td> <td>C Check Digit.</td> </tr> <tr> <td>NNNNN C#### X</td> <td>(5-D Item/C/4-D Wgt)</td> <td>O The number zero.</td> </tr> <tr> <td>NNNNN \$\$\$\$ X</td> <td>(5-D Item/5-D Price)</td> <td>\$ Total Price Digits.</td> </tr> <tr> <td>NNNNN N\$\$\$ X</td> <td>(6-D Item/4-D Price)</td> <td># Weight Digits.</td> </tr> <tr> <td>NNNNN O\$\$\$ X</td> <td>(5-D Item/O/4-D Price)</td> <td>X Symbol Check Digit.</td> </tr> <tr> <td>NNNNN C\$\$\$ X</td> <td>(5-D Item/C/4-D Price)</td> <td>D Digit.</td> </tr> </table>	NNNNN ##### X	(5-D Item/5-D Wgt)	Format Codes:	NNNNN N#### X	(6-D Item/4-D Wgt)	N Item number Digits.	NNNNN O#### X	(5-D Item/O/4-D Wgt)	C Check Digit.	NNNNN C#### X	(5-D Item/C/4-D Wgt)	O The number zero.	NNNNN \$\$\$\$ X	(5-D Item/5-D Price)	\$ Total Price Digits.	NNNNN N\$\$\$ X	(6-D Item/4-D Price)	# Weight Digits.	NNNNN O\$\$\$ X	(5-D Item/O/4-D Price)	X Symbol Check Digit.	NNNNN C\$\$\$ X	(5-D Item/C/4-D Price)	D Digit.
NNNNN ##### X	(5-D Item/5-D Wgt)	Format Codes:																							
NNNNN N#### X	(6-D Item/4-D Wgt)	N Item number Digits.																							
NNNNN O#### X	(5-D Item/O/4-D Wgt)	C Check Digit.																							
NNNNN C#### X	(5-D Item/C/4-D Wgt)	O The number zero.																							
NNNNN \$\$\$\$ X	(5-D Item/5-D Price)	\$ Total Price Digits.																							
NNNNN N\$\$\$ X	(6-D Item/4-D Price)	# Weight Digits.																							
NNNNN O\$\$\$ X	(5-D Item/O/4-D Price)	X Symbol Check Digit.																							
NNNNN C\$\$\$ X	(5-D Item/C/4-D Price)	D Digit.																							
<p>Price Check Override</p>	<p>When a PLU contains a command to turn off the price check digit, (Ex: Action Code 49), this selection determines what will print in the price check digit space. A hard zero or a six-digit item number can be selected.</p>																								
<p>Manufacturer Number</p>	<p>This selection allows for a default five-digit manufacturer number, when used with type 0, 1, 3, 5, 6, or 7 bar codes, replacing the first five MSD digits of the item number.</p>																								

EAN-13 Barcode



<p>By-Weight Prefix By-Count Prefix Std. Pack Prefix Run Total Prefix</p>	<p>Enter the bar code prefix. The default is 21.</p>																								
<p>By-Weight Format By-Count Format Std. Pack Format Run Total Format</p>	<p>Refer to the code explanations on the left.</p> <table border="0"> <tr> <td>NNNNC ##### X</td> <td>(4-D Item/C/5-D Wgt)</td> <td>Format Codes:</td> </tr> <tr> <td>NNNNN ##### X</td> <td>(5-D Item/5-D Wgt)</td> <td>N Item number Digits.</td> </tr> <tr> <td>NNNNC \$\$\$\$ X</td> <td>(4-D Item/C /5-D Price)</td> <td>C Check Digit.</td> </tr> <tr> <td>NNNNN C\$\$\$ X</td> <td>(5-D Item/C/4-D Price)</td> <td>O The number zero.</td> </tr> <tr> <td>NNNNN \$\$\$\$ X</td> <td>(4-D Item/6-D Price)</td> <td>\$ Total Price Digits.</td> </tr> <tr> <td>NNNNN \$\$\$\$ X</td> <td>(5-D Item/5-D Price)</td> <td># Weight Digit.</td> </tr> <tr> <td>NNNNN N\$\$\$ X</td> <td>(6-D Item/4-D Price)</td> <td>X Symbol Check Digit.</td> </tr> <tr> <td></td> <td></td> <td>D Digit.</td> </tr> </table>	NNNNC ##### X	(4-D Item/C/5-D Wgt)	Format Codes:	NNNNN ##### X	(5-D Item/5-D Wgt)	N Item number Digits.	NNNNC \$\$\$\$ X	(4-D Item/C /5-D Price)	C Check Digit.	NNNNN C\$\$\$ X	(5-D Item/C/4-D Price)	O The number zero.	NNNNN \$\$\$\$ X	(4-D Item/6-D Price)	\$ Total Price Digits.	NNNNN \$\$\$\$ X	(5-D Item/5-D Price)	# Weight Digit.	NNNNN N\$\$\$ X	(6-D Item/4-D Price)	X Symbol Check Digit.			D Digit.
NNNNC ##### X	(4-D Item/C/5-D Wgt)	Format Codes:																							
NNNNN ##### X	(5-D Item/5-D Wgt)	N Item number Digits.																							
NNNNC \$\$\$\$ X	(4-D Item/C /5-D Price)	C Check Digit.																							
NNNNN C\$\$\$ X	(5-D Item/C/4-D Price)	O The number zero.																							
NNNNN \$\$\$\$ X	(4-D Item/6-D Price)	\$ Total Price Digits.																							
NNNNN \$\$\$\$ X	(5-D Item/5-D Price)	# Weight Digit.																							
NNNNN N\$\$\$ X	(6-D Item/4-D Price)	X Symbol Check Digit.																							
		D Digit.																							

EAN-128 Barcodes

AN-128 is an application standard of the GS1 implementation using the Code 128 barcode specification. It is commonly called GS1-128. It uses a series of Application Identifiers to include additional data such as use-by dates, batch numbers, quantities, weights and more. The bar code can be configured by touching one of the format boxes to open the Barcode Format Pattern editor.



GS1 Databar Barcodes

GS1 Databar is a stacked barcode that can have up to 3 rows of barcode data. It can contain up to 7 different pieces of information (Application IDs). The data always contains the Application ID 01 or GTIN number (the 14 digit item number of the PLU), and can contain the following optional Application IDs (in order generated in the barcode):

ID	Data Item	Notes
01	GTIN	Always selected, 14 digit Item Number
392x	Total Price	up to 15 digits, "x" is decimal position
8005	Unit Price	6 digits (no precision indicated)
15	Sell By Date	6 digits (YYMMDD)
17	Use By Date	6 digits (YYMMDD)
13	Pack Date	6 digits (YYMMDD)
3103*	Net Wt (KG)	6 digits, lower 3 are right of decimal point
3202*	Net Wt (Lb)	6 digits, lower 2 are right of decimal point
30*	Count	up to 8 digits

* = can contain one of these fields based on loadcell setting and package type (BW/BC/SP)

The desired fields can be configured in the PLU record or in Setup / Barcode Settings if the PLU record is set to "Use Scale Settings". The Barcode Settings screen has an additional checkbox to put a human readable text line under the barcode. Only one line of text will be drawn and the number of characters depends on the width of the barcode field. Since this symbology is "variable width" based on the number of fields selected, the barcode will be rendered from the starting position (top, left) of the barcode field defined in the label format, and continue to the right edge of the label. It will be rendered for the specified field height. If the data will not fit in one row of bars, two or three rows will be generated, each row being one half or one third of the height.



Presets Setup

Presets are used for one-touch call up of PLU records. Instead of entering the PLU number, the preset keys are assigned for a specific PLU number and department. When the preset key is pressed, the PLU is automatically called up. There can be many pages of presets and the PLUs can be retrieved from any department. The pages are selected using the Page Buttons at the bottom of the screen. You must first configure the pages, and then the preset keys for that page can be configured. With Version 4.2 or later, a "Graphical Tare" page can be created with the preset editor.

Preset Quick Key Editor

Note: This feature is valid for scale application versions 4.3 or later.

The Preset Quick Key Editor is used to add or modify preset keys from the Main screen. This feature must be enabled in Setup Mode.

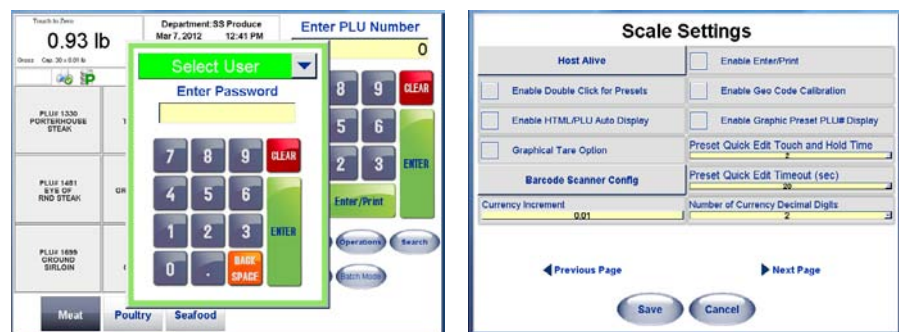

To enable this feature, navigate to Setup → Unit Setup → Scale Settings. From the last page, change the "Preset Quick Edit Touch and Hold Time" to the amount of seconds you would like to hold down the Preset to configure it. To disable this feature, set it to 0.

The "Preset Quick Edit Timeout" setting selects the time before the Preset Quick Edit Screen will change back to the Main Screen without any activity. Any changes made without saving will be lost if the timeout returns back to the Main screen.

There will be always a Security Login Screen before you get to the Edit Screen, even if Security is not configured in the scale. Only Supervisor or Technicians can log in. There is NO Operator login for this feature. When you successfully logged in, you can add, remove and swap presets, only for the Preset Page you logged in. No functions are available to delete or swap a Navigation Preset. After saving, the system reverts back to normal mode, where you can switch pages and re-enter the editor.

Tare can be entered by either selecting the preset key, entering the value, or by placing the container on the platter then pressing the "Platter Tare" key. Graphical tare is enabled from the Unit Setup/Scale Settings page 3. (Version 4.4 screens shown)

Page 1: Unit Setup

Choose Department: Dept: 0
 Tare to Use: 1
 Scale Mode: Prepack-print on weight change only
 Price Settings: By Weight Pricing: B: Round Free Up, C: Round Free Up, Calculated Price: B: Round Free Up, Pricing Method: T: Calculate member price first, % Discount: B: Round Free Up, By Count Pricing: A: Truncate Up
 Manual Mode Keys: Allow lbs for, Allow By Qtr Pound, Allow By Half Pound
 Enabled Features: AutoPreset
 Buttons: Accumulator Setup, Scale Settings, Save, Help, Cancel

Page 2: Scale Settings

Print Mixed Net Weight:
 Calculate Std Pack Unit Price per-lb:
 Select Primary Locale: English (United States)
 Select Alternate Locale: French (Canada)
 Select Customer Display Locale: English (United States)
 Tabular NF Overrides: Use Standard Tabular
 HTML by PLU:
 Allow Alternate Language:
 Buttons: Next Page, Cancel

Page 3: Scale Settings

Host Alive: Enable Enter/Print
 Enable Double Click for Presets
 Enable HTML/PLU Auto Display
 Graphical Tare Option
 Enable Geo Code Calibration
 Enable Graphic Preset PLU# Display
 Preset Quick Edit Touch and Hold Time: 2
 Preset Quick Edit Timeout (sec): 20
 Currency Increment: 0.01
 Number of Currency Decimal Digits: 2
 Buttons: Previous Page, Next Page, Save, Cancel

Pages

Here is an example screen that has been configured with various departments.

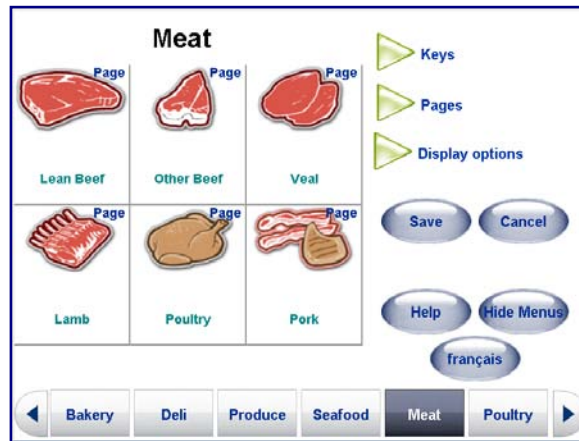

Pages are represented by the buttons along the bottom of the screen, usually different departments. To setup preset pages, press the **Pages** button.

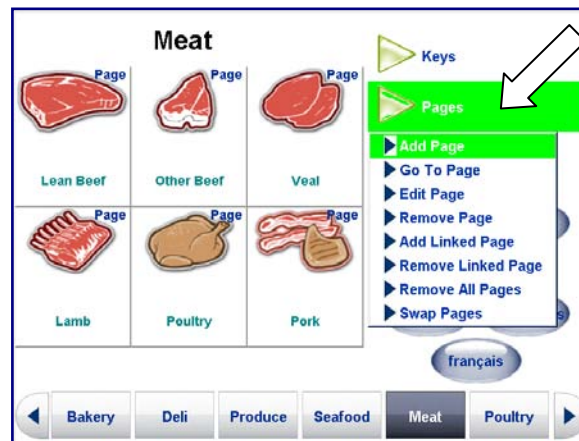

Then select the action you want to perform **Add**, **Go to**, **Edit**, or **Remove a Page**, you can also **Add** or **Remove a Linked Page**, as well as **Remove** all pages or **Swap Pages**.

Add Page

To add new pages, touch the **Pages** button (1) then select **Add Page** (2).

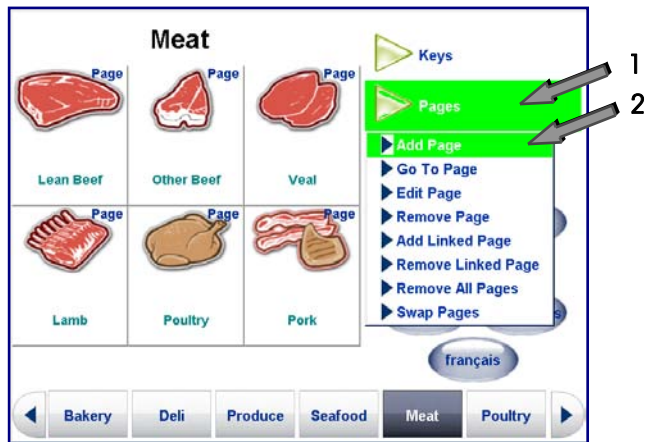

Press the **Page Format** box (1) and select **Text-based page**, **Graphical page** or **Graphical Tare page**. Press the **Page Layout** (2) and select the number and size of the preset keys on the page (4x3, 4x4, or 4x6 Text or Graphical Preset) or (2x2, 2x3, 3x2, or 3x3 Graphical Tare).

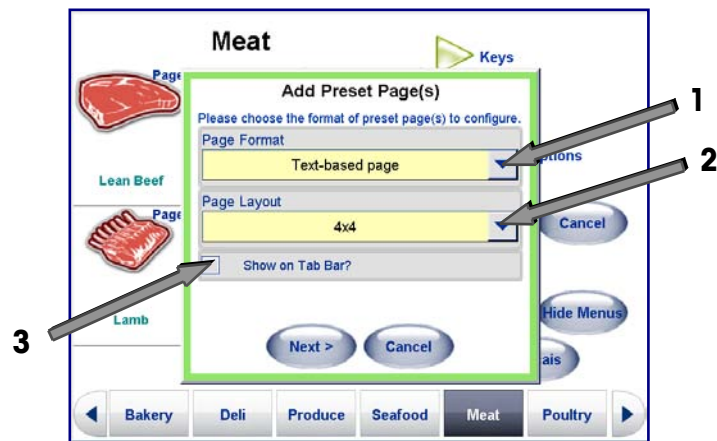

If you wish the page to be accessed using a button on the bottom of the screen, select the check box **Show on Tab Bar?** (3). If the page will be used as a link accessed by pressing one of the preset keys, leave the box unchecked.

Press the **Next>** button to continue the Page setup. Add pages automatically by selecting **By Department** for the **Page Type**, or manually using **Custom**.

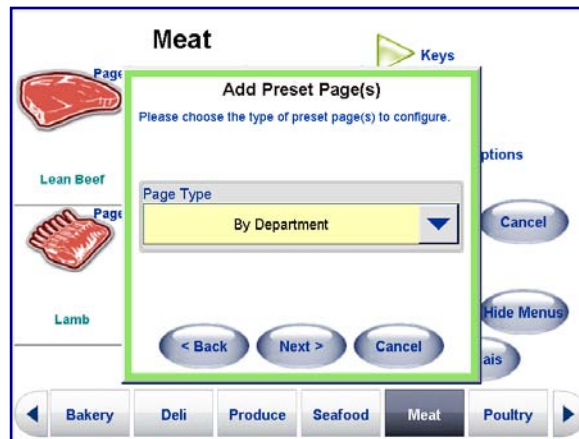

If you select **By Department**, pages of preset keys for all PLUs in that department will be created. To program the preset keys manually, select "Custom" from the drop down menu. Select either "By Department" or "Custom" from the drop down list and press **Next>** to continue.

Adding Preset Pages By Department

If you are adding pages by department, next select the department from the drop down list and press **Next>** to continue. Select the department page you wish to create from the drop down menu.

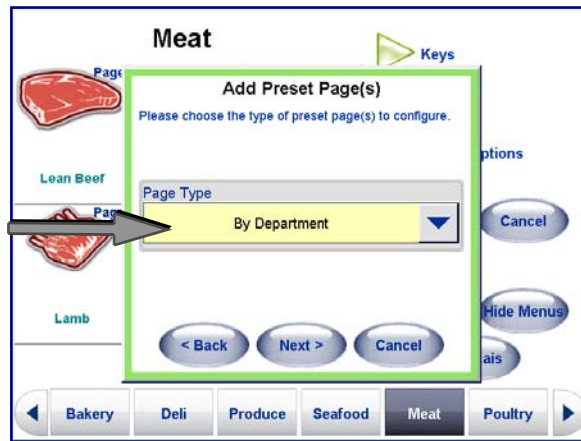

Based on which department you selected, the number of pages automatically created will correspond to all PLUs from that selected department.



You can go back by pressing the **<Back** button, finish by pressing the **Done** button, or cancel all by pressing **Cancel**.

Note: When you are all done programming presets, press the **Save** button before exiting the Presets Menu to save your settings.

Adding Pages using Custom

First select **Custom** from the dropdown menu, then press **Next>**.

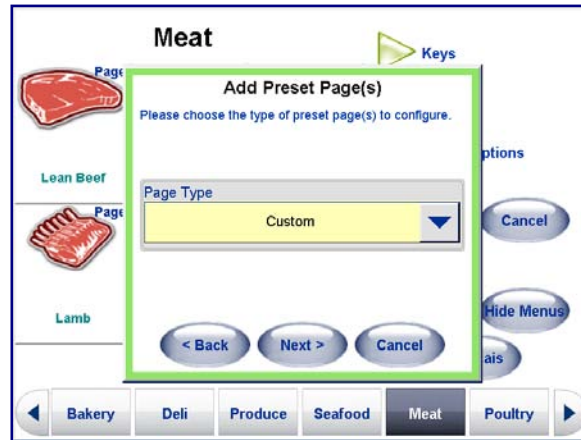

This will give you a page where you can **Rename** the page (all new pages default to "Page X") and / or give the page an **Alternate Name**. An Alternate Name is used when the Alternate Language button is pressed.

The same process is used to set or edit the **Alternate Name** or to **Rename Page**.

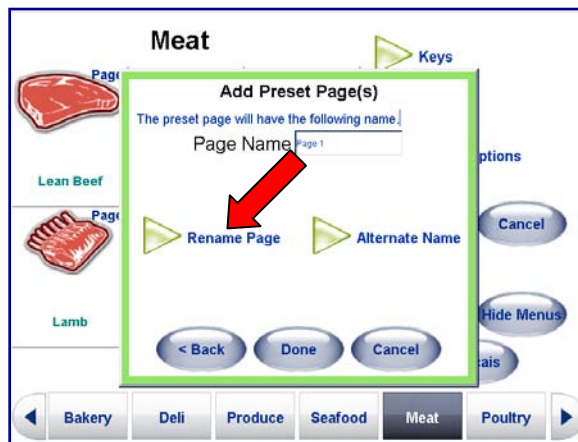

To edit the new page name, press the **Rename Page** button, and then type in the new page name. Press the **Apply** button when you have completed the new Page name.

NOTE: When you are finished programming presets, be sure to press SAVE before exiting or the changes will not be saved.

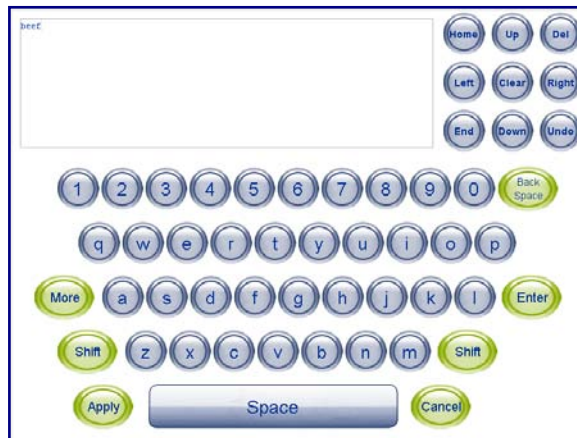

This will return you to the Add Preset Page screen. To go back press the **<Back** button, finish by pressing the **Done** button, or cancel all by pressing **Cancel**.

Note: When you are all done programming presets, press the **Save** button before exiting the Presets Menu to save your settings.

Edit Page

Editing a Page is similar to Adding a Page, only you are modifying an existing Preset Page, rather than creating one.

Select the Page you want to edit along the bottom bar (1), press the **Pages** button then select **Edit Page** (2) from the dropdown menu.

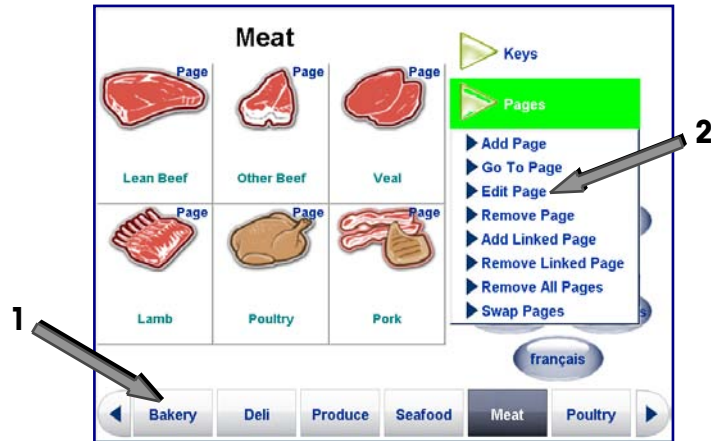

This will return the **Edit Preset Page** screen. From here you can edit the **Page Name**, the **Alternate Name**, and the **Page Layout**. You can also modify the **Show on Tab Bar?** option. When checked the Page will appear as a button along the bottom of the screens.

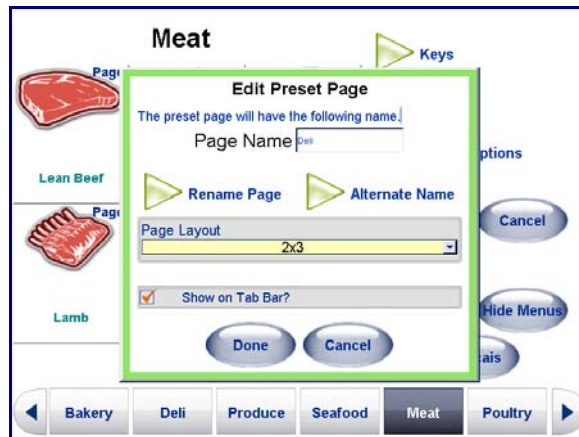

Graphical Tare Presets

The Tare override (by pressing the Tare box on a By Weight PLU) will bring up the Graphical Tare screen. Tare can be entered by either selecting the preset key, entering the value, or by placing the container on the platter then pressing the "Platter Tare" key.



The Graphical Tare feature is enabled by Unit Setup / Scale Settings. If the feature is enabled but no tare pages are configured, then the standard Forced Tare wizard will be used. The graphic images for the containers exist in a sub-directory of the "Mettler Toledo\Service\images" directory called "tares".

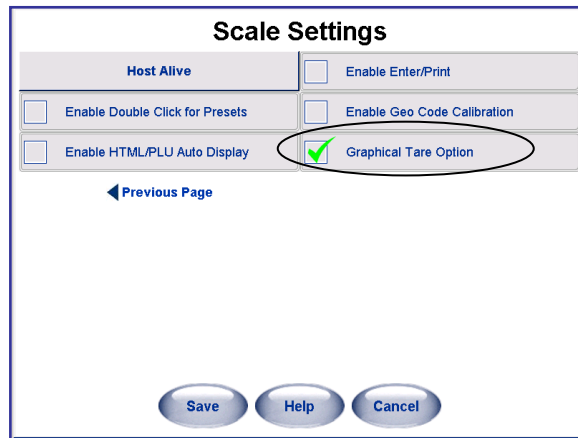

The graphical tare pages are created within the presets menu. When you select Preset Setup and Add Page, you can select a Graphical Tare page type and select the page layout.

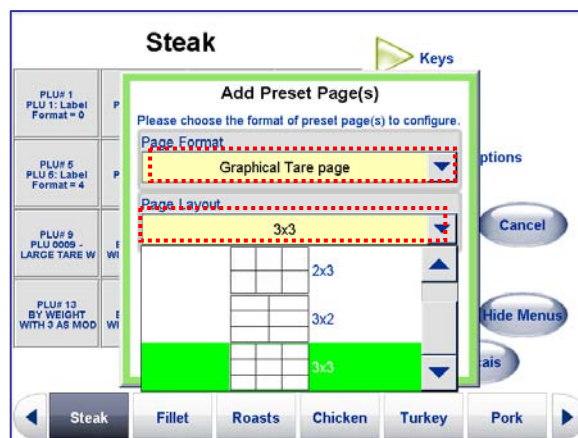

Next, press a key and the Edit Preset button.

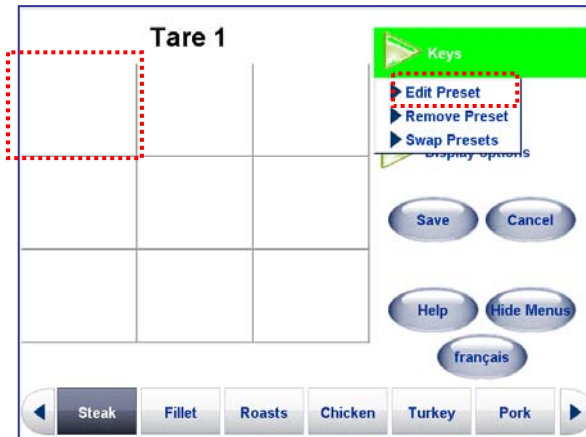

Enter the Description, tare, and choose a graphic. Standard tray and bag images are supplied with the Commander. The tare value is shown as Line 2 of the description. It is automatically inserted when the tare is entered and should not be manually edited. Press **Done** to save and exit.

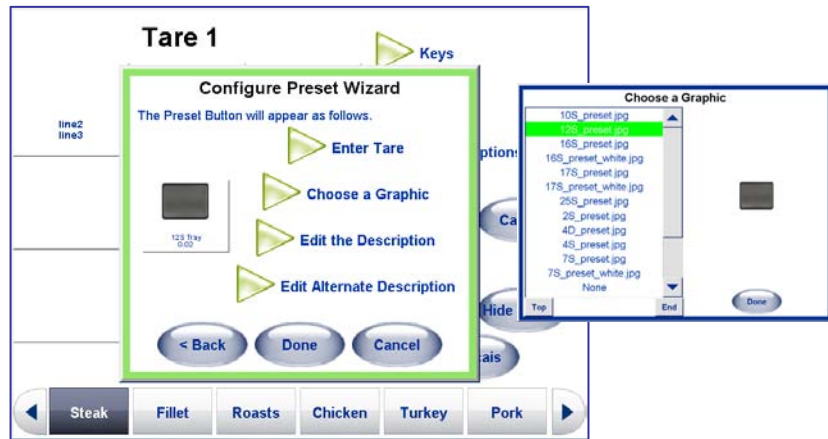

When you are finished with the page, press Save to save the new page and to exit.

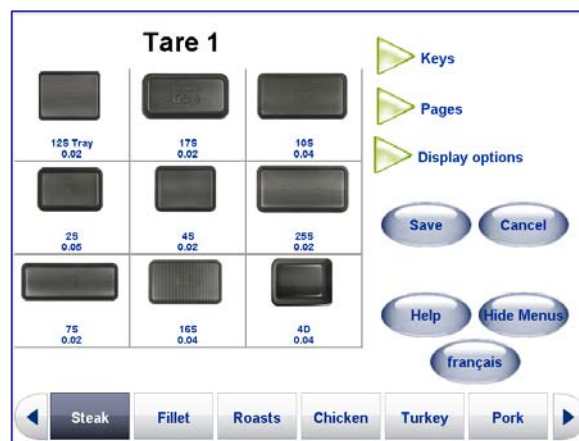

Keys

Edit Preset Keys

Use **Edit Preset** to add or modify a preset **Key (PLU)**. To **ADD** a preset: select a blank (empty) preset key and then press the **Keys** button. Select **Edit Preset** from the dropdown menu. To **EDIT** an existing preset: to modify an existing preset button select a populated preset button and then press the **Keys** button. Select **Edit Preset** from the dropdown menu. Follow the below instructions for the next step for both **Adding** and **Editing** a Preset Key. Press **Choose PLU** to select a PLU for the key or **Choose Page** to have the key link to another Preset page.

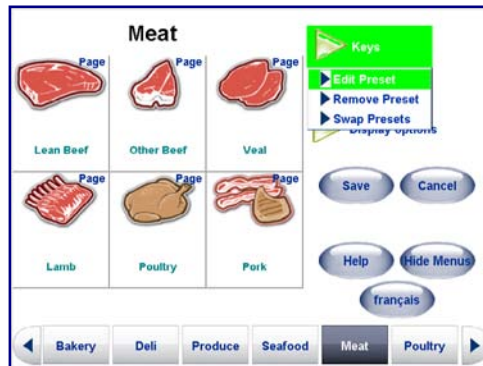

Choose PLU

To select a new PLU, touch the **Choose PLU** key. Press the **Next>** key to continue without changing the PLU. If you pressed the **Choose PLU** button, there are two methods to find PLU; **List** and **Search**.

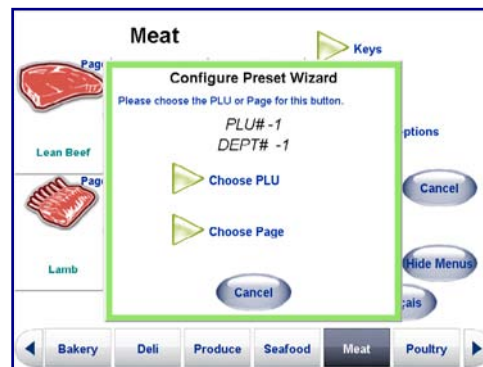

List Method

Select the department where the PLU is located by touching the + button next to the department. You can scroll through the list of PLU numbers. Select the PLU you wish to use by touching it so it is highlighted, then press the **Select** key. This will return you to the PLU number in the **Configure Preset Wizard** screen.

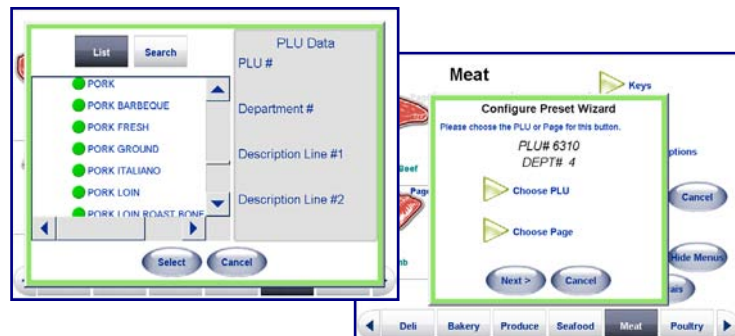

Search Method

If you use the **Search** key, you can find a PLU by the **PLU number** or the **PLU description**.

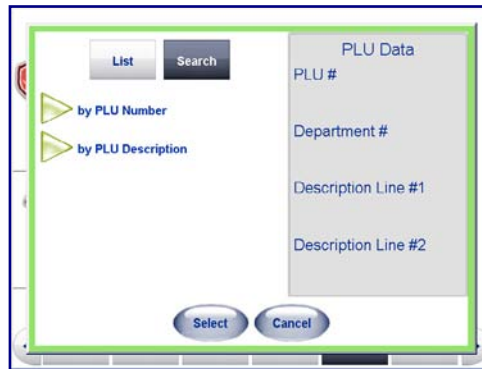

Select **by PLU Number** if you know an individual PLU's number. You will be prompted with a keypad, enter the number by touching the screen.

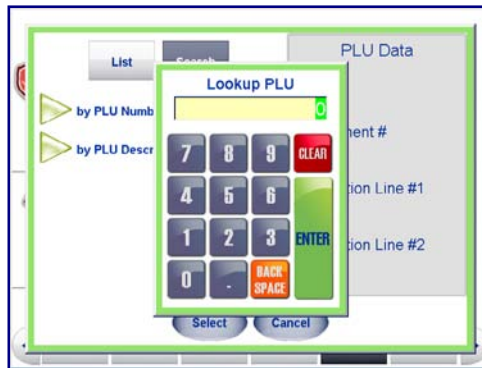

After entering the number, press **Enter**. If the number is valid it will return details on the number for you to select on the page. If the number is not a valid PLU number, you will receive a screen telling you it does not match.

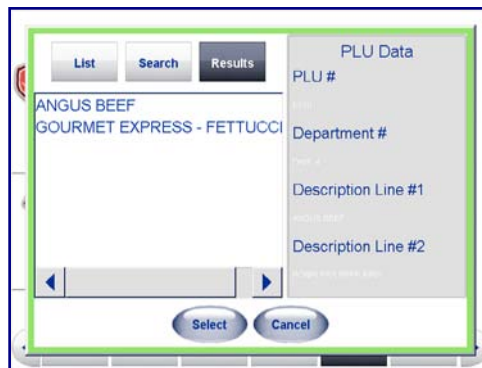

Select the Search method, **by PLU Description** if you want to return a list of possible PLUs.

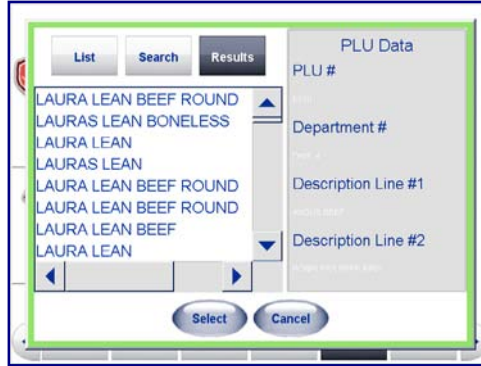

This will give you a keyboard to type in a phrase or part of a phrase that will be searched in the PLUs. After typing in the search, press **Apply**.

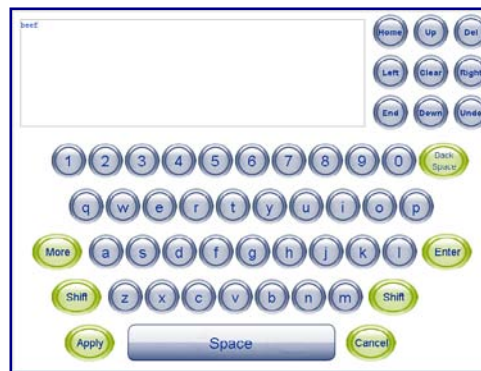

For example, a search of the description "lean" returned the following results:

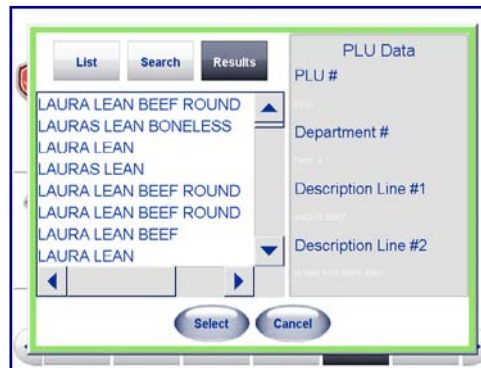

Highlight the PLU you wish to use, then press the **Select** key. By pressing the **Edit the Description** or **Alternate Description** key, you can modify those descriptions, or go back to select a different PLU by pressing **<Back**, or complete the procedure by pressing **Done**.

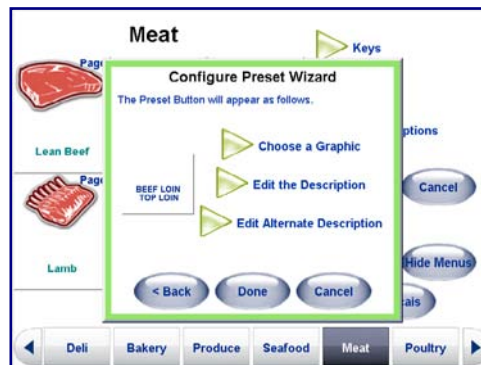

At this point, you can press **Done** to quit or program another preset. When finished, press the **Save** button to save and exit. To exit without saving any of the changes, press the **Cancel** button.

Choose Page

To link a preset key to another preset page (rather than a PLU), touch the **Choose Page** button.

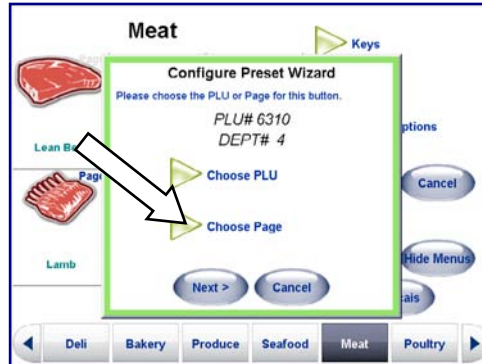

The returned list will have all available Preset Pages that you could assign to the Preset Key. Touch the page you wish to assign to the key. Once highlighted, page details will appear on the right. Touch the **Select** button once you have made your selection.

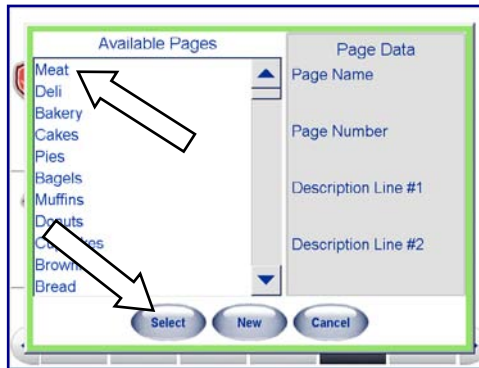

You will be returned to the **Configure Preset Wizard**, the Page Name and Page # lines will reflect the Page # you just selected. Press the **Next>** button.

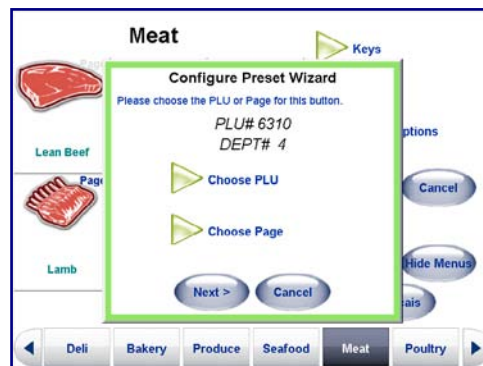

On the next **Configure Preset Wizard** screen you can **Choose a Graphic**, **Edit the Description** and the **Alternate Description** of the Preset Page you just added. Note: this is not a global Description name change. Any Description changes will only apply to this instance where the Page has been added in as a Key.

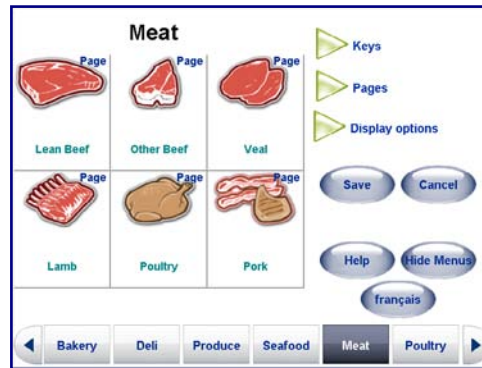
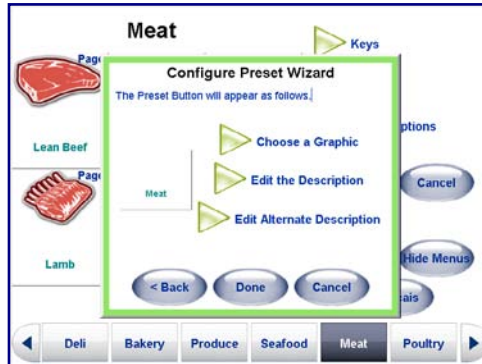

Configure Preset Wizard

Modify the Preset Button color, description, and alternate description.

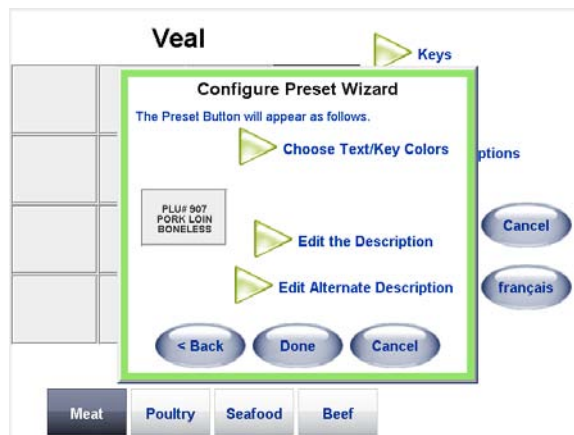

To change the preset button color, press the "Choose Text/Key Colors" button.

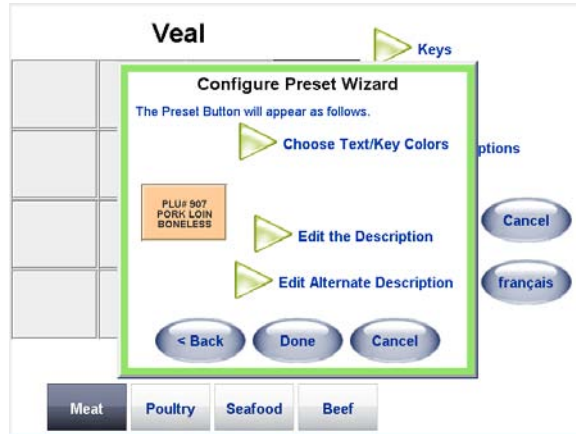

Select the new color combination to use for the preset button.

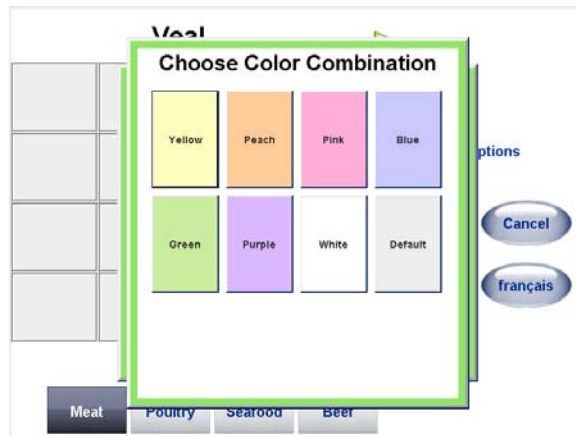

The new button with the color selected will be shown in the preset grid.

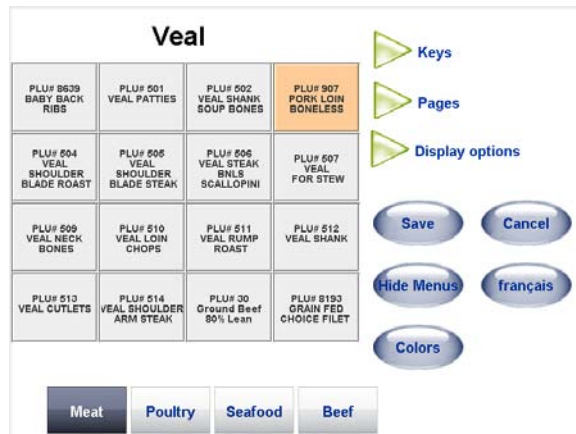

Chapter 6: Controller - Touchscreen Presets Setup

To create a custom color combination, press the Colors button. Touch the combination to change.

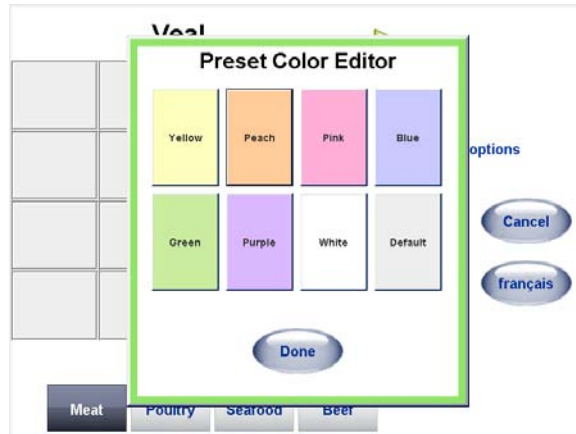

Select the new colors for background and text. Press OK when done.

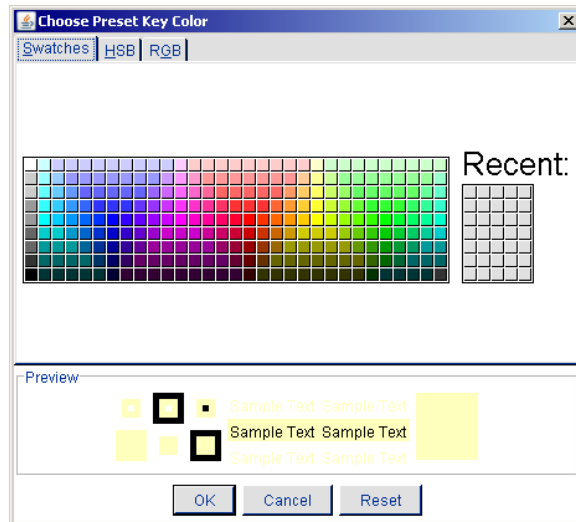

Backroom Setup

This selection is used to configure Items such as Indexer, Date Forward, Macros, Option Screen Overrides, and to view Indexing Errors. Backroom Setup also provides a summary of Hardware Information for easy reference.



Choose Indexer

From the **Choose Indexer** field select which type of Indexer will be used, or NONE. The Default for Commander is **648**. This should only be changed by a technician.

Date Forward Hour

From the **Date Forward Hour** field select which hour the shelf life / use by date advances. This function can be used to advance the date one day for items packed late in the day.

Cycle Lifter, Cycle Xfer, Cycle Convey

These buttons will move the Lifter, Transfer Belt (Xfer), or Discharge Conveyor when pressed.

Macros Setup

Macros allow you to program a button to perform tasks such as changing the tare, discounting the price, etc. There are standard macros already installed. You can edit these macros, delete any macros, and add new macros.

The macro can include the following items:

Macros Setup				
Name	PLU type	Tare	Discount Type	Amount
Family Pack	By_Wgt	0.00	Unit Price Discount	0.00
Family Pack	By_Cnt	0.00	None	None
Family Pack	Std_Pk	0.00	None	None
Inventory	By_Wgt	0.00	% Off Total Price	10
Inventory	By_Cnt	0.00	None	None
Inventory	Std_Pk	0.00	None	None
Rewrap	By_Wgt	0.00	None	None

Macro Name – The name of the macro will be used on the button text.

Tare – The tare configured in the macro can temporarily override the PLU tare.

Discount Type – Select None, Unit Price Discount, or % (percentage) off Total Price.

Amount – If Unit Price Discount is selected, enter the amount that will be subtracted from the PLU programmed price. If % off Total Price is selected, enter the percentage you wish to discount the PLU total price (example: enter 10 for a 10% discount).

Accumulator – You can specify if you wish to have the transaction recorded in a different accumulator that you specify. Select the Rewrap, Inventory, or a custom accumulator you have created. Note: Accumulator options can be customized by using the Accumulator Setup Screen (from the Unit Setup).

ADD MACRO

To **ADD** a new macro, press the **Add Macro** button.

Configure Macro	
Macro Name	Tare
<input type="text"/>	0.00
Discount Type	Discount
None	None
Accumulator	
Inventory(l)	

Next, fill in details of the new macro:

Macro Name – touch the blank field to bring up the keyboard. Enter in the name of the new macro.

Discount Type – using the drop down menu select **Unit Price Discount** or **% Off Total Price** depending on what type of discount will be applied. If no discount is to be used, select **None**.

Discount Amount – touch blank field to bring up a keypad. From here enter a fixed amount that will be discounted. Press **Enter** when finished.

Accumulator – using the drop down select an accumulator (totals) to apply to this macro.

Tare – touch the blank field to bring up a keypad. From here enter a the Tare to be assigned to this macro. Press **Enter** when finished.

Press the **Save** button to save your new macro, or **Cancel** to exit without saving.

The new macro will be created and listed three times (four if fractional pricing is enabled). The macro is duplicated for each of the pricing modes which are listed as codes when you scroll to the right to view the PLU Type column. The codes are as follows:

- 0 = By Weight Pricing
- 1 = By-Count Pricing
- 2 = Fractional Pricing (when enabled in setup)
- 3 = Standard Pack Pricing

EDIT MACRO

The macro can be configured different for each pricing mode using the **Edit Macro** function. Highlight the macro to edit and then select **Edit Macro**.

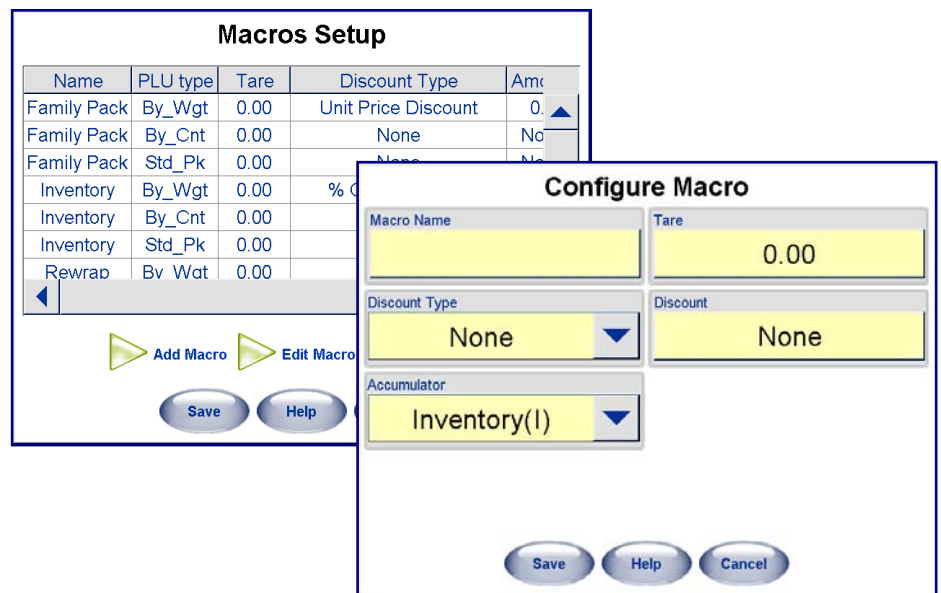

Now the existing macro's name, discount type, accumulator, tare, and discount amount can all be edited.

Press the **Save** button to save your changes, or **Cancel** to exit without saving.

DELETE MACRO

A macro can be deleted entirely by highlighting it and selecting **Delete Macro**.

Macro Placement

This feature allows you to customize up to 4 macro buttons. You can enable/disable any of the macros from this screen. You can also swap positions, replace and remove the listed Macros. **Note: There are 8 positions shown, but only the top 4 can be used in the Commander.**

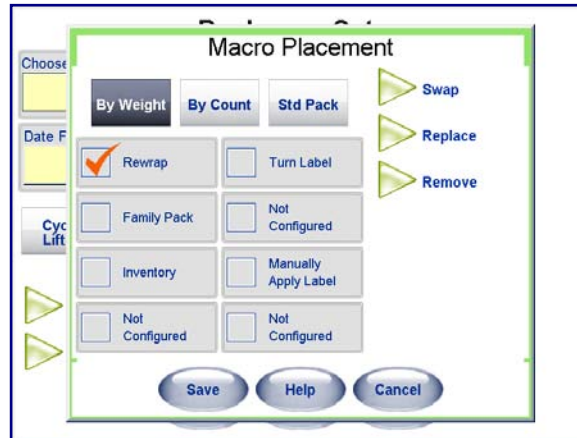

Rewrap – Flags the item as being previously labeled.

Turn Label – When the PrePack controller is used with an automatic label applicator, selecting this macro will turn the label 90°.

Family Pack – Discounts the item unit by \$.10. This can be changed in Macros Setup.

Bottom Label – When a bottom label applicator is used, this will force the unit to apply a bottom label to the package.

Inventory – Not used on Commander.

Manually Apply Label – Not used on Commander.

Not Configured – Bottom two not used on Commander.

Setup Passwords/Levels

The Commander can support up to 9999 unique Operator IDs. Each Operator ID and Supervisor can have different security settings, permissions, and all transactions can be reportable. Passwords are used to limit access to various functions, both in Operator setup security and for Operator transaction use.

To enable the use of passwords, the **“Use Security”** box must be checked. When this is checked, passwords will be required to enter into the setup mode.

For Operator transaction security and tracking, the **“Operator Password Required”** box must be checked. When this is checked the Operator will have to enter their password to perform certain functions on the Commander.

Both passwords can be up to 5 digits and must be numeric. The Supervisor defaults with access to all functions.

The screenshot shows a software interface titled "Setup Passwords/Levels". It features three input fields at the top: "Supervisor" (containing the text "Supervisor"), "Password" (containing "---"), and "Manage Operators". Below these fields are three checkboxes: "Operator Mode", "Use Security", and "Operator Password Required". At the bottom of the interface are two buttons labeled "Save" and "Cancel".

Quick Edits

The **Quick Edits** selection is used to change some of the more common numeric data in a PLU record. The Quick Edit function changes the record in the database immediately. Items that can be changed include the price, tare, shelf-life, and use-by date. Quick Edits are accessed by pressing the Setup button on the Main screen. The Setup screen is shown below.

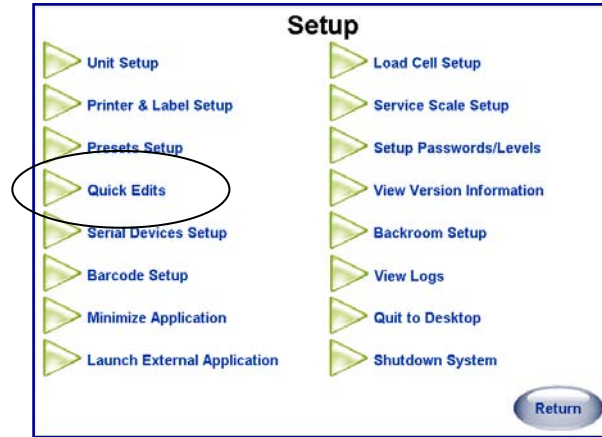

Touch the Quick Edits button to enter the Quick Edits mode and select the department (below). Press Next to continue or Cancel to exit.

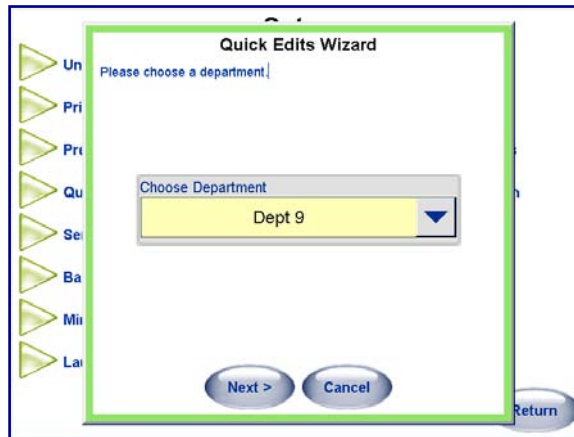

The Quick Edits screen displays the current department. Type in the PLU number and press the Enter key. The PLU data will be retrieved from the database. To change any of the displayed fields, touch the box that displays the data.

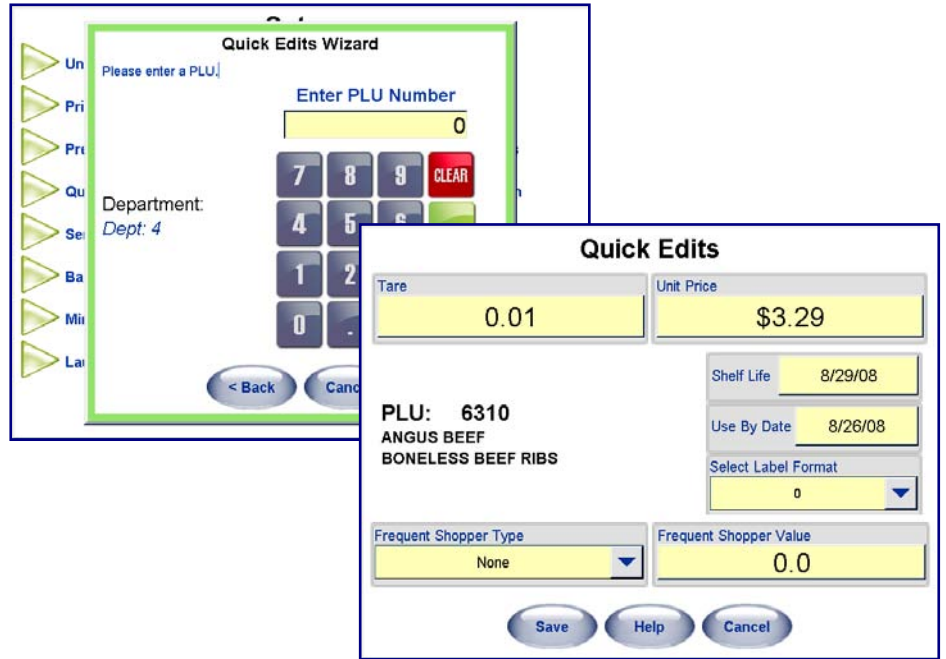

The PLU can also be converted to a Frequent Shopper price by touching the Frequent Shopper Type and Price boxes.

To change the Shelf Life or Use By dates by touching the appropriate boxes and selecting a new date from the calendar.

Touch the arrow keys at the top to change the month. You can also enter the date numerically by touching the "Use Numerical Keypad" key.

Touch the new date, and then press the OK key to make the change.



Repeat this process for any other items that need to be modified.

View Version Information

This button will display the Commander Controller software version and part number, as well as the IP address.

View Logs

Used for service to aid in troubleshooting problems. This includes a calibration and error log, as well as this screen logs certain items that are required by Weights and Measures NTEP regulations. The error log is a display of the current genx.log file.

Minimize Application

Minimizes the application (without exiting) to the task bar.

Serial Devices Setup

This screen is used to configure devices connected to the Commander Controller such as the printers, load cell, and indexer. Do not change this setup or you could disable a device. The Refresh button can be used to attempt to re-establish communications with an offline device if it does not reset normally.

In version 4.2 or later, this function can be accessed through the Operations button on the Main Screen.

The screenshot shows a window titled "Serial Devices Setup". It contains three dropdown menus for configuration:

- Load Cell: COM2
- Label Printer: USB
- Indexer: COM1

At the bottom of the window are three buttons: Refresh, Help, and Cancel.

Load Cell Setup

This function is used to setup the Load Cell weighing component. Normally, only a qualified technician should make any changes in this area. See **Commander Service Manual** for details.

Launch External Program

Use this function to access the UC Editor (Windows only), UC SmartLabel (Windows only), Production Reports (Windows only), Task Manager (Windows), and Touchscreen Calibrator; as well as any user loaded programs. Details are in the UC Line Software Tech Manual for these external applications.

Note: Although not required, it is recommended that a USB wired or wireless mouse and are available if planning on using any external applications.

Note: If the Wrapper's machine covers are opened while an external application is running causing an error window to open, use the keyboard's ALT-TAB (Windows) or Alt-F1 (Linux) to return to the application.

UC Editor

UC Editor is a tool supplied with each UC scale or controller to edit PLU data in the UC database. Refer to the UC Line Software Technical Manual for details.

UC Smartlabel

UC Smartlabel is a Windows program used to design and manage custom label formats. Refer to the UC Line Software Technical Manual for details.

Task Manager

Task Manager is an optional program that features scheduling and managing tasks. Refer to Chapter 9 Extra Programs for details.

Production Reports

Production Reports is an optional program used to create reports from the UC database transaction records. From the Setup screen, select Launch External Application, from here you can access the Commander Production Reports tool. From here you can generate the reports. Refer to Chapter 9 Extra Programs for details.

Quit To Desktop

This button will exit from the application and return to the OS desktop. Although not required, it is recommended that a USB mouse and keyboard are available to navigate the desktop.

Shutdown System

Shutdown the Controller and the operating system.

7

Cleaning and Maintenance

Daily Cleaning

Always switch the power off to the Commander before performing any cleaning.
Never aim water directly at or inside the machine or at the electrical panel or control board or spray in a manner where the splashing water could enter and damage equipment components.

	WARNING
	ELECTRICAL SHOCK HAZARD Disconnect and lock out all power to this unit before removing or installing the fuse, cleaning, or servicing.



	NOTICE
	TO PREVENT EQUIPMENT DAMAGE Do not direct water or steam at the inside or outside of the machine. Keep moisture away from the inside of the electrical panel and control electronics.

The Commander is designed to make cleaning operations simple and fast. The following items require attention daily or more frequent as required. Refer to the illustration below for locations of the components on the following pages. Always disconnect power before you start cleaning the unit.

	 WARNING
	<p>ELECTRICAL SHOCK HAZARD Disconnect and lock out all power to this unit before removing or installing the fuse, cleaning, or servicing.</p>

	 CAUTION
	<p>BURN HAZARD Hot surface. Allow to cool before servicing or cleaning.</p>

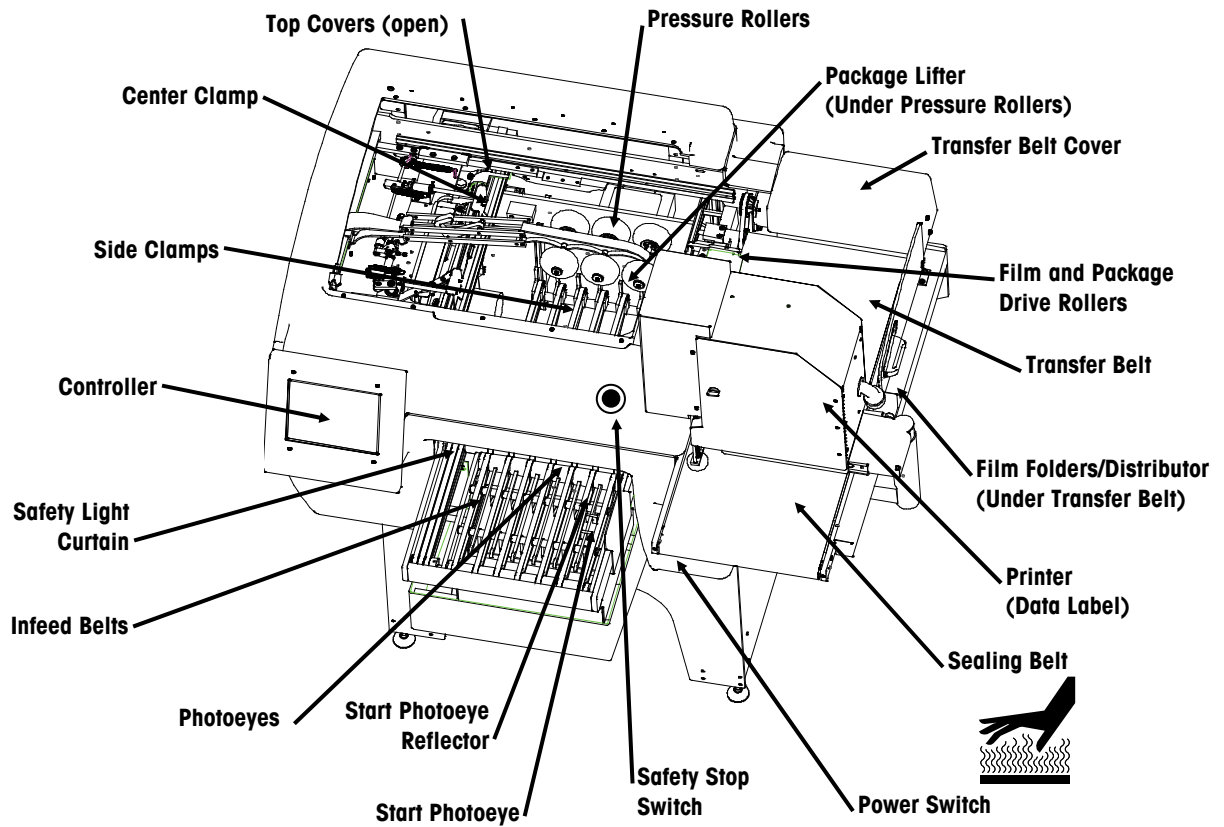

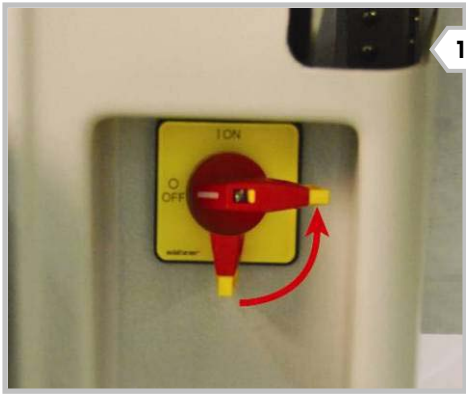

1

Turn off the power switch, located at the front right of the machine, by rotating the red lever counter-clockwise.



2

Lift up to open the top cover raising it up until it is held in the open position.



Next, open the clear side cover over the transfer belt. Clean the sealing belt and transfer belt with a soft cloth dampened with hot water and a mild detergent. **Caution! The sealing belt may be hot! Allow to cool before cleaning.**



4

Clean the film drive roller (next to the transfer belt) with a soft cloth dampened with hot water and a mild detergent. Remove any debris from the roller. **Caution! Watch out for the cutter blade below when cleaning this area.**

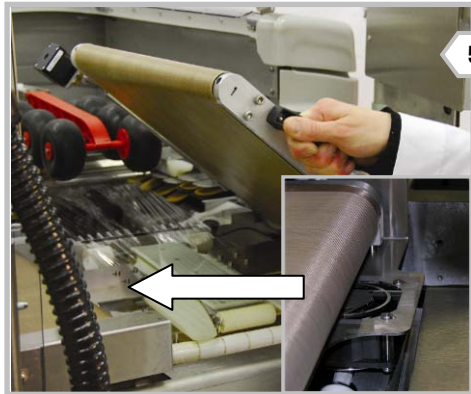

5

Raise the transfer belt for access to the distributor film clamp and film folders below it. Remove any debris from the top and bottom of the transfer belt fan (located between the transfer and sealing belts).

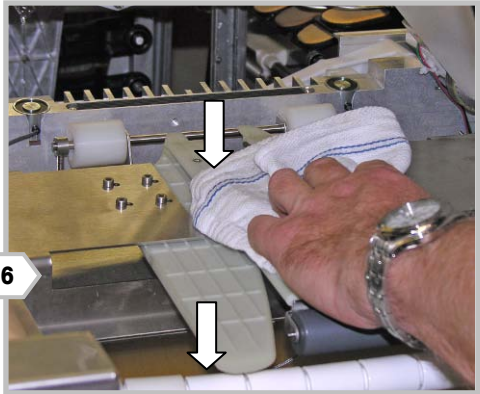

6

Clean the film folders and curved rollers with a soft cloth dampened with hot water and a mild detergent.



7

Clean the distributor film clamp with a soft cloth dampened with hot water and a mild detergent.



8

Press down on the release lever and remove any debris from the comb. Clean the film gripper on the center clamp with isopropyl alcohol or hot water and detergent. Wipe the surfaces dry before using the machine.



Clean the pressure rollers with a soft cloth dampened with hot water and a mild detergent. Remove any debris from the rollers.

Clean the tops (A) of the side clamps with a soft cloth dampened with hot water and a mild detergent. Press down on each of the clamps (B) to expose the gripper pads (C). Clean each of the pads (C) with soft cloth dampened with hot water and a mild detergent. Allow to dry before using the machine.

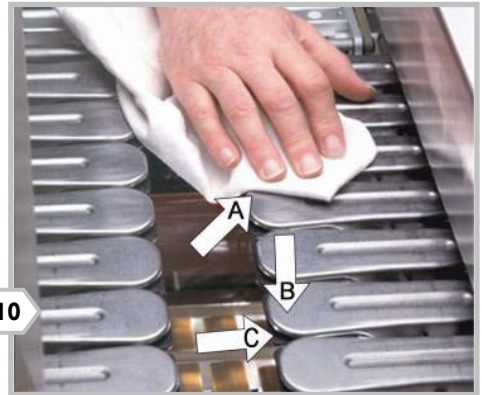

Remove the scale risers by grasping them in the middle and pulling them upward (additional details on next page).

Remove the scale platter by lifting the platter up and out. Clean daily using hot water, detergent, and a brush to clean the slots. Dry all the parts and replace in the infeed.



Clean the lifter and belt surfaces with a soft cloth dampened with hot water and a mild detergent.

Clean the photoeyes with a soft cloth dampened with hot water and a mild detergent. **Do not use a paper towel or other abrasive material. It will scratch the photoeye lens.** Wipe off all infeed belts.



Clean the infeed belt surfaces with a soft cloth dampened with hot water and a mild detergent.

Wipe off all exterior surfaces with a soft cloth dampened with a mild detergent.



Infeed Cleaning



NOTE: do not spray water into this area!



As the point of entry to the machine, the Infeed and Scale often need extra cleaning. Begin by removing the **metal risers**:

1. Grab the riser body near the center (indicated by arrow below).
2. Pull firmly upward (see below) but be careful not to bend the riser.
3. Set aside for detailed cleaning.

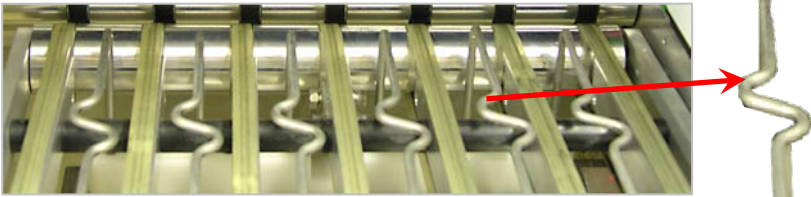

Remove for Cleaning

1. Wipe off using a wash cloth and mild detergent or if heavy cleaning is needed, take the risers and rinse in a bucket with warm water and a mild detergent.
2. Take a wash cloth with cleaning solution and wipe down the scale platter.

Re-inserting

1. Insert the risers with the raised hump toward the front of the machine (closest the operator, see below). Align the riser ends with holes in the infeed platter.
2. Push the riser into its holes, flexing the ends as necessary to make sure they insert properly.
3. Press firmly down on the riser's center.
4. Inspect for basic level. If one side is obviously higher or lower than the other, pull out the riser and reinstall it.



Clean the reflector on the scale platter. If it is dirty or covered with any debris, this can cause E65 or E66 errors.



Raised area to the front of the machine.

	NOTICE
	TO PREVENT EQUIPMENT DAMAGE Do not direct water or steam at the inside or outside of the machine. Keep moisture away from the inside of the electrical panel and control electronics.

Controller Cleaning

- Do not use solvents or commercial cleaners on the unit. They may harm the surfaces or damage the touchscreen.
- **Do not spray directly on or at the unit!**
- Touchscreen - Only use a soft clean cloth dampened with mild detergent and water to clean the Touchscreen. Do not scrape with sharp objects.
- Controller Covers – Clean using a soft clean cloth dampened with a mild cleaner or detergent and water.

	NOTICE
	TO PREVENT EQUIPMENT DAMAGE Do not direct water or steam at the inside or outside of the machine. Keep moisture away from the inside of the electrical panel and control electronics.



	WARNING
	ELECTRICAL SHOCK HAZARD Disconnect and lock out all power to this unit before removing or installing the fuse, cleaning, or servicing.

Printer Cleaning

	 WARNING
	ELECTRICAL SHOCK HAZARD Disconnect and lock out all power to this unit before removing or installing the fuse, cleaning, or servicing.

	NOTICE
	TO PREVENT EQUIPMENT DAMAGE Do not direct water or steam at the inside or outside of the machine. Keep moisture away from the inside of the electrical panel and control electronics.



Before cleaning, open the printer door and press the printer Power Switch to the OFF position. (Your system may have one or two printers.)



Do not spray or wash down these machines. Do not pour or spray water or any liquid directly onto any part of these machines.



Supplies you will need include: a mild detergent, alcohol, soft cleaning cloths, METTLER TOLEDO Cleaning Pen (P/N 082287020), and hot water.

Clean all covers with a soft cloth dampened with hot water and a mild detergent. Remove any labels stuck to the covers and use a cloth dampened with alcohol to remove any glue residue.



Remove the lock pin and rotate the printer(s) away from the body of the Commander for easy access to the applicator head and skis.

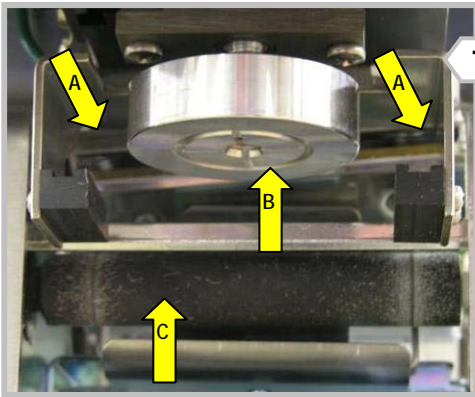

1 Clean the label delivery skis (A) and applicator head (B) with a soft cloth dampened with alcohol. Clean the rubber platen roller (C) with a soft cloth dampened with a mild detergent. Note: see below for additional DayGlo Printer specifics.

Next, unlock the printhead by first lifting up on the rear of the printhead (1) and then pivoting the assembly up (2).

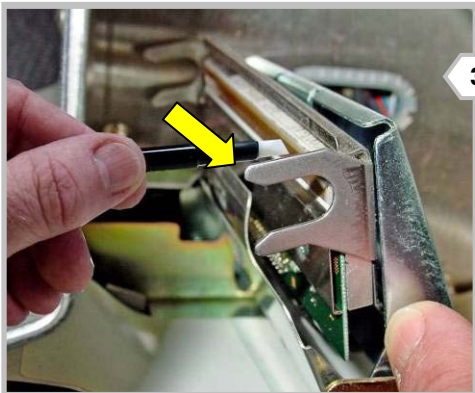
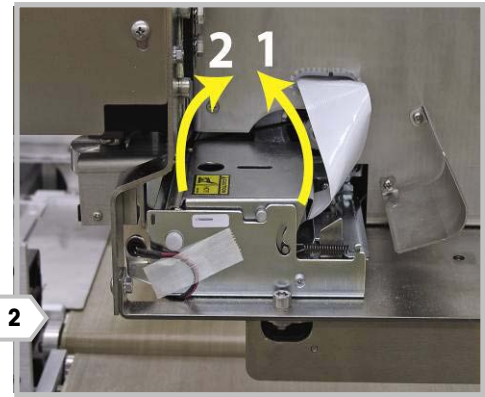

3 Clean any glue or label debris from the printhead with the Mettler Toledo cleaning pen (082287020) or a soft cloth and alcohol. Do not scrape or use any sharp object that could damage the printhead.

Use a soft clean brush or air to blow any label dust from the printer gap sensor. Do this also when loading a new roll of labels. When you are finished, turn the power switch back to ON.

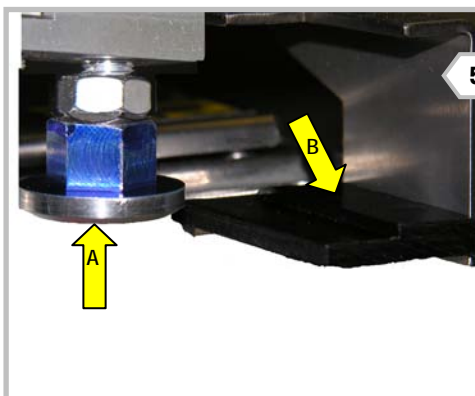
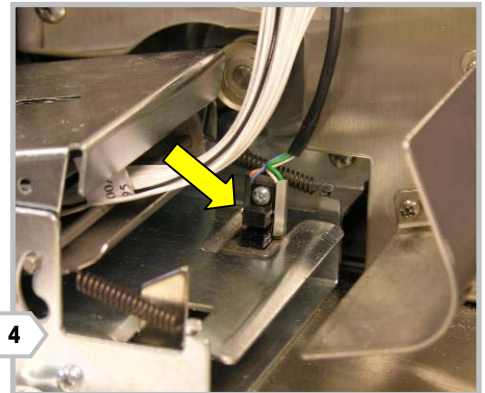

5 If your system includes the DayGlo printer, clean the applicator head (A) and ski (B) with rubbing alcohol. Pay special attention to adhesive residue buildup on the inboard vertical edge of the ski.

8

Troubleshooting

Printer Troubleshooting

This section shows common questions and symptoms that can be used as an aid in troubleshooting the printer and label applicator.

	NOTICE
	<p>TO PREVENT EQUIPMENT DAMAGE Do not use any metal or sharp object to scrape the printhead or the printer platen roller. This may cause serious equipment damage.</p>

No Label Prints

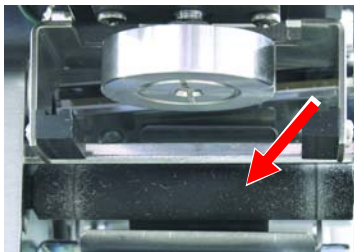

Clean the Platen Roller

Possible Cause	Solution
Out of Labels	Check Label Supply.
Labels Jammed	Check labels and remove jam. Clean any labels and glue residue from guides and platen roller using alcohol or the Cleaning Pen (refer to Daily Cleaning Section).
No Power To Printer	Check Power to Printer. Is Power LED on? Check Printer Power Switch.
Labels slipping on platen roller	Clean any labels and glue residue from guides and platen roller using alcohol or the Cleaning Pen (refer to Daily Cleaning Section).
Dirty Take Label Sensor	Clean the sensor using a soft brush (refer to Daily Cleaning Section).
Improper Setup	Enter Setup then select Serial Devices/Setup/Refresh
Unknown Cause	Cycle power to printer. Call for service if problem persists.

Pick/Apply Problems



Possible Causes	Solution
Label Skis Position	Label Skis must be in the down position for automatic application.
No Vacuum on Applicator	Check applicator head for stuck label or debris preventing vacuum from holding the label on the head when applying. Clean if necessary with alcohol and a clean cloth. Call for service if problem persists.
Label Stop Position	Labels may not be feeding out enough causing too much of the label to be stuck on the liner. First clean the platen roller and gap sensor, then retry. Check Label Eject value in setup. If problem persists, call for service.
Unknown Cause	Cycle power to printer and retry. If printer communication error results, enter Operations Menu and use Reset Printer button (Software version 4.2 or later). Call for service if problem persists.

Label Placement Varies



Possible Causes	Solution
Wrapping Mode Change	Was wrapping mode changed from Manual Mode to Normal Mode? Occasionally, changing from Manual Mode to Normal Mode, causes the first label in Normal Mode to have improper label delivery. After the first package in Normal Mode the labels should be placed properly.
Packages slipping on belts	Clean Infeed belts, transfer belt, and sealing belt. (See Cleaning Section or Wrapper Cleaning Guide).
Improper feeding of packages	Place packages square and against the guide. Do not place the package too far into the machine. Package could also be dragging on a riser that is not fully inserted.
No Vacuum on Applicator	Is the applicator head holding the label after it is fed? Check applicator head for stuck label or debris preventing vacuum from holding the label on the head when applying. Clean if necessary with alcohol and a clean cloth. Call for service if problem persists.
Unknown Cause	Cycle power to printer and retry. If printer communication error results, enter Operations Menu and use Reset Printer button (ver 4.2 or later). Call for service if problem persists.

Label Applicator Won't Turn Labels

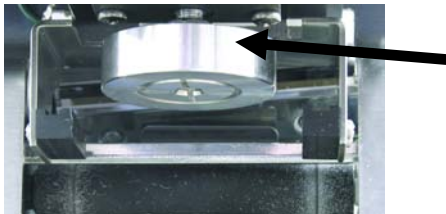

Possible Causes	Solution
Applicator Head Loose	Tighten applicator lock nut.
Improper Setup	Check Label Turn Mode setting.
Unknown Cause	Cycle power to printer and retry. If printer communication error results, enter Operations Menu and use Reset Printer button (ver 4.2 or later). Call for service if problem persists.

Light/Mottled Print

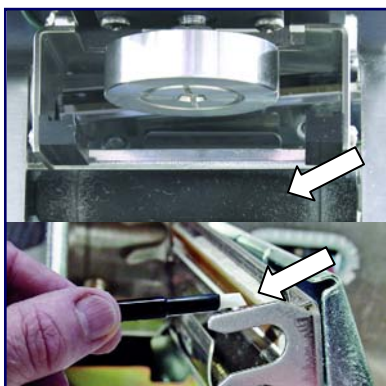

Possible Causes	Solution
Printhead Not Latched	Latch the Printhead.
Dirty Roller or Printhead	Clean Printhead and Platen Roller with alcohol or cleaning pen. Clean any residue from platen roller. (Refer to Cleaning Section).
Defective Labels	Test printing with known good batch of labels.
Unknown Cause	Cycle power to printer and retry. Call for service if problem persists.

Extra Labels Print

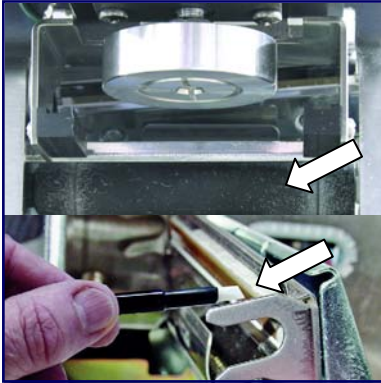

Possible Causes	Solution
Label Delivery Mode Incorrect	Check label format for stripped/unstripped mode. In automatic applications, the format must be set to Stripped Mode.
Dirty Roller or Printhead	Clean Printhead and Platen Roller with alcohol or cleaning pen. (Refer to Cleaning Section or Cleaning Guide).
Incorrect Calibration or Eject Length	Check Eject Length in Setup/Label Printer. Reset to lower value and retry. Calibrate Printer (in Setup mode.)
Defective Labels	Test printing with known good batch of labels.
Unknown Cause	Turn power off, hold label feed button, turn power back on. Release button after 10 sec. Catch labels as they feed out. Retry. Call for service if problem persists.

Incorrect Label Indexing

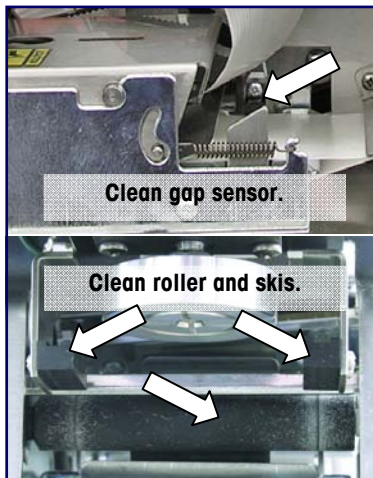

Possible Causes	Solution
Labels not installed correctly	Check that labels are installed correctly, against the label guides, and in the gap sensor.
Printhead Not Latched	Latch the Printhead.
Dirty Roller, Printhead, Gap Sensor	Clean Printhead and Platen Roller with alcohol or cleaning pen. Clean the gap sensor with a soft brush. (Refer to Cleaning Section).
Incorrect Calibration or Eject Length	Check Eject Length in Setup/Label Printer. Reset to higher/lower value and retry. Calibrate Printer (in Setup mode.)
Defective Labels	Test printing with known good batch of labels.
Unknown Cause	Turn power off, hold label feed button, turn power back on. Release button after 10 sec. Catch labels as they feed out. Retry. Call for service if problem persists.

Wrapper Troubleshooting

Following are lists of common symptoms to aid in troubleshooting wrapping problems.

Film Tears or Tracks Poorly

Possible Causes	Solution
Film Installed Incorrectly	Check film against the threading diagram.
Defective film.	Replace film with new roll. If error persists, call for Service.

Gaps in Film, Poor or No Overwrap



Possible Causes	Solution
Film Not Locked on Bobbin	Center the film on the bobbin and tighten knob.
Film Pulling out of center clamp.	Clean center clamp.
Film Pulling out of side clamps	Near end of roll - change roll. Clean side clamp gripper pads and allow time to dry. Retry operation after machine is dry.
Wrong Film Tension setting	Check that the Film Tension (set on the Wrapper Control screen) is set for the recommended tension for the type of package being used.
More film on one side of the package or open on one side.	Film roll is not centered. Check film installation. Center the film on the roller.
Unknown Causes	If error persists, call for service.

Not Picking Film

Possible Causes	Solution
Incorrect Wrapping Mode	Is Prewrap selected? Check on Wrapper Control Screen. Weigh/Wrap/Label uses Normal Mode.
Transfer Belt open or out of place.	Lift and reclose Transfer Belt.
Film incorrectly loaded.	Reload Film and lock the roll on the bobbin by tightening the locking knob.
Center clamp dirty.	Remove any film or debris from clamp. Clean the center clamp and allow to dry. Retry operation.
Film wrapped around distributor film roller.	Remove any film or debris from distributor film roller. If error persists, call for Service.
Unknown Causes	Turn wrapper power switch off then back on and restart wrapper. Call for Service if problem persists.

Error Logs

There are two logs that are maintained to record error for the Controller Only and for the Complete System.

Controller Error Log

For Controller specific error information, from the **Setup Screen** click on **View Error Logs**.

The screenshot shows the 'Setup' menu with 'View Error Logs' selected. Below it, the 'Error Log' window is open, displaying a table of log entries. The table has columns for Level, Date/Time, and Category. The log entries include various error and warning messages such as 'System.err: at java.awt.EventQueueThread.run(Unknown So', 'Fatal ERROR: mDiscslav.dll Not Found', and 'Setup DBVersion: MTCB_4_0_072808'.

Level	Date/Time	Category
ERROR	8/28/08 11:07:28 AM EDT	Engineer: System.err: at java.awt.EventQueueThread.run(Unknown So
INFO	8/28/08 7:25:44 AM EDT	Engineer: System.out: Cannot Open File C:\Program Files\Mettler Toledo
DEBUG	8/28/08 7:25:45 AM EDT	Engineer: Fatal ERROR: mDiscslav.dll Not Found
DEBUG	8/28/08 7:25:45 AM EDT	Engineer: initGetDisplayType FAILED: C:\Program Files\Mettler Toledo\G
DEBUG	8/28/08 7:25:45 AM EDT	Engineer: Looking for USB DISPLAY Type 0
INFO	8/28/08 7:25:45 AM EDT	Engineer: JobDriver: Enumerate Status: #Devices=4
INFO	8/28/08 7:25:45 AM EDT	Engineer: Enumerate Status: #Devices=4
INFO	8/28/08 7:25:45 AM EDT	Engineer: Openno null 4, MarqueeDisplay
INFO	8/28/08 7:25:45 AM EDT	Engineer: Return from openFX 1
ERROR	8/28/08 7:25:45 AM EDT	Engineer: JobDriver: openUI ERROR: MarqueeDisplay is not initialized.
DEBUG	8/28/08 7:25:45 AM EDT	Engineer: UNKNOWN DISPLAY TYPE 0
INFO	8/28/08 7:25:45 AM EDT	Engineer: System.out: Setting Window Size: java.awt.Dimensionwidth=1
DEBUG	8/28/08 7:25:46 AM EDT	Engineer: *****
INFO	8/28/08 7:25:46 AM EDT	Engineer: Starting the com.mtl.service.PhobosScaleApp application...
DEBUG	8/28/08 7:25:46 AM EDT	Engineer: System.out: Find_Trace_Bay: init_trace_io = false, cc = false
INFO	8/28/08 7:25:46 AM EDT	Engineer: TimedAnn: Message 4596:1220009148826: SetupFactor: que
INFO	8/28/08 7:25:46 AM EDT	Engineer: TimedAnn: Message 100:1220009148936: SetupFactor: que
WARN	8/28/08 7:25:49 AM EDT	Engineer: Setup DBVersion: MTCB_4_0_072808
WARN	8/28/08 7:25:49 AM EDT	Engineer: ScaleAppVersion: Fusion_4_0_07282008 HF2
WARN	8/28/08 7:25:49 AM EDT	Engineer: Application's Supported Ver: 4_0_0
WARN	8/28/08 7:25:49 AM EDT	Engineer: Item DBVersion: MTCB_4_0_072808
WARN	8/28/08 7:25:49 AM EDT	Engineer: ScaleAppVersion: Fusion_4_0_07282008 HF2
WARN	8/28/08 7:25:49 AM EDT	Engineer: Application's Supported Ver: 4_0_0
INFO	8/28/08 7:25:49 AM EDT	Engineer: TimedAnn: Message 80:1220009148996: SetupFactor: que
INFO	8/28/08 7:25:49 AM EDT	Engineer: TimedAnn: Message 80:1220009149076: SetupFactor: que
INFO	8/28/08 7:25:49 AM EDT	Engineer: TimedAnn: Message 51:1220009149127: SetupFactor: que

The error log is used for service to aid in troubleshooting problems. The calibration log shows the items that are required by Weights and Measures NTEP regulations. The error log is a display of the current genx.log file.

Wrapper System Error Log

For troubleshooting the entire Commander system, go to the **Wrapper Control** screen (from the main screen click on the **Wrapper** button or from the PLU edit screen click on **Wrapper Program** box).



The Errors logs can be viewed by clicking on Last 10 Errors that will display the last 10 errors the wrapper reported or clicking on All Hardware Errors.

Clicking on **All Hardware Errors** will display all the errors (controller, wrapper, indexer) that the system had since last service. This list can be sorted and displayed by date of problem, the area the problem occurred (controller, wrapper, indexer) or by Error Description.

			Error Log	Calibration Log
Level	Date/Time	Category		
ERROR	8/29/08 11:18:25 AM EDT	Engineer	System.err: at java.awt.EventQueueThread.run(Unknown So	
INFO	8/29/08 7:25:44 AM EDT	Engineer	System.out: Cannot Open file C:\Program Files\Mettler Toledo\	
DEBUG	8/29/08 7:25:45 AM EDT	Engineer	Fatal ERROR: mDisolav all Not Found	
DEBUG	8/29/08 7:25:45 AM EDT	Engineer	inCalDisplayType FAILED: C:\Program Files\Mettler Toledo\Se	
DEBUG	8/29/08 7:25:45 AM EDT	Engineer	Looking for USB DISPLAY TYPE 0	
INFO	8/29/08 7:25:45 AM EDT	Engineer	UsbDriver: Enumerate Status: #devices=4	
INFO	8/29/08 7:25:45 AM EDT	Engineer	Enumerate Status: #devices=4	
INFO	8/29/08 7:25:45 AM EDT	Engineer	Opening null 4 MarqueeDisolav	
INFO	8/29/08 7:25:45 AM EDT	Engineer	Return from openP4-1	
ERROR	8/29/08 7:25:45 AM EDT	Engineer	UsbDriver: open(1) ERROR: MarqueeDisolav is not initialized	
DEBUG	8/29/08 7:25:45 AM EDT	Engineer	UNKNOWN DISPLAY TYPE 0	
INFO	8/29/08 7:25:45 AM EDT	Engineer	System.out: Setting Window Size: java.awt.Dimension width=1	
DEBUG	8/29/08 7:25:46 AM EDT	Engineer	#####	
DEBUG	8/29/08 7:25:46 AM EDT	Engineer	Starting the com.mtservice.ProcessCalData application	
INFO	8/29/08 7:25:46 AM EDT	Engineer	System.out: Field Trace flags: Init= false, IO= false, GC= false	
INFO	8/29/08 7:25:48 AM EDT	Engineer	Timestamp Message: 4596.1220009148836: SetupFactory: que	
INFO	8/29/08 7:25:48 AM EDT	Engineer	Application's Succeeded: Ver: 4 0	
WARN	8/29/08 7:25:48 AM EDT	Engineer	Setup DBVersion: MTDB_4_0_072808	
WARN	8/29/08 7:25:48 AM EDT	Engineer	ScaleAppVersion: Fusion_4_0_07282008 HF2	
WARN	8/29/08 7:25:48 AM EDT	Engineer	Application's Succeeded: Ver: 4 0	
WARN	8/29/08 7:25:48 AM EDT	Engineer	Item DBVersion: MTDB_4_0_0728608	
WARN	8/29/08 7:25:48 AM EDT	Engineer	ScaleAppVersion: Fusion_4_0_07282008 HF2	
WARN	8/29/08 7:25:48 AM EDT	Engineer	Application's Succeeded: Ver: 4 0	
INFO	8/29/08 7:25:49 AM EDT	Engineer	Timestamp Message: 80.1220009148996: SetupFactory: que	
INFO	8/29/08 7:25:49 AM EDT	Engineer	Timestamp Message: 80.1220009148976: SetupFactory: que	
INFO	8/29/08 7:25:49 AM EDT	Engineer	Timestamp Message: 51.1220009149127: SetupFactory: que	

Wrapper Status Screens

When certain errors occur, the Error Display screen will be activated. The message and illustration will show the area where the problem is located and give suggested solutions.



Commander Error Codes

Below is a list of status messages or error messages that may display.

Code	Description	Solution
101	Service Test Jumper Installed and Photoeye Blocked on power up.	Call for Service.
107 108 109	Internal Wrapper Error	Power down wrapper and controller, then restart wrapper and controller. If problem persists, call for service.
110	Lifter Stalled Or Lifter Sensor Not Working	Verify there are no packages jammed in wrapper. Turn wrapper power switch off momentarily then back on and restart wrapper. Call for Service if problem persists.
111	Infeed Photoeye Blocked On Power-Up	Check the Infeed area to verify that it is clear. Clean the Photoeyes and remove any debris. Call for Service if problem persists.
113	Conveyor Photoeye Blocked On Power-Up	Check for jam on lifter - remove jam. Clean Photoeyes and remove any debris. Call for Service if problem persists.

Code	Description	Solution
120	Weighing Error	Do not touch packages when weighing. Packages must not rock and must be stable while on the scale. Press RESET and rerun package. Verify platter and risers are not touching any supports or belts. If problem persists, call for service.
121	Wrapper Timeout, Pack on Infeed was removed	A package was temporarily detected by the package detection photoeye. If this was not the case, the photoeye or the reflector could also require cleaning. Press RESET and retry.
122	Package not detected by the Transfer Belt Photoeye	The package may be stopped in the wrapper or on the Transfer Belt.
123	Package blocking the Transfer Belt Photoeye	A package may be stopped between Transfer and Sealing Belts. Check/clean Photoeye between Transfer belt and Sealing belts. Check package placement when placing on infeed belts. Refer to the guide on the infeed.
130 132 133 134	Price Label Applicator Internal Error	Turn wrapper power switch off momentarily then back on and restart wrapper. If error persists, call for service.
135	Price Label Not Ready To Be Applied	The package arrived at the printer, but the label is missing. Check price label printer and labels. Rerun package. If problem persists, call for service.
136 137	Price Label Printer Internal Error	Press RESET and run another package. Turn the printer power switch off momentarily, and then back on. Press the label feed button. If a label did not come out, shut down the controller and turn the wrapper power switch off. Switch the wrapper power back to on and then the Controller. When the system is ready, retry operation. Call for Service if problem persists.
140 141 142 143 144 145 146 147	DayGlo Printer Internal Error	Check DayGlo printer. Turn DayGlo printer power switch off momentarily then back on. Press the label feed button. If a label did not come out, shut down the controller and turn the wrapper power switch off. Switch the wrapper power back to on and then the Controller. When the system is ready, retry operation. If error persists, call for service.
150	Indexer Internal Error	Turn the wrapper main power switch off momentarily and back on. Retry operation. If error persists, call for service.
E00	Wrapper Ready	Normal startup message. Press start.

**Chapter 8: Troubleshooting
Wrapper Status Screens**

Code	Description	Solution
E01	Machine starting, the power is on	Wait for E00 to be displayed and then push start.
E02	Machine CPU Reset	Wait for E00 to be displayed and then push start.
E03	Safety Stop –Covers open or Safety Photoeye Blocked	Check that all covers are closed correctly, the Stop Switch is not depressed, and the Safety Photoeye is not blocked. Clean photoeyes (see cleaning section). If error persists call for service.
E04	Open Top Cover / Remove package	After a package jam, open the top cover and check for a package, piece of debris, or wad of film left in the machine. The object may have caused the jam or may have been created by the jam.
E06 E07	Battery Backed Ram Failure or Error	Wrapper CPU battery backed RAM information (package counts, errors, etc.) is corrupt and the battery may have failed. Turn wrapper power switch off momentarily then back to on. If error persists, call for service.
E20	The High and Low Lifter Sensors active at the Same Time	Remove all packages from Commander. Turn wrapper power switch off momentarily then back to on and touch Start. If error persists call for service.
E21	The Low Lifter Sensor was active when it should not be activated.	Remove all packages from Commander. Turn wrapper power switch off momentarily then back to on and touch Start. If error persists call for service.
E22	The Low Lifter Sensor was not active when it should be activated.	Remove any packages and make sure the lifter will move to the bottom of its stroke level with the infeed belts. Turn wrapper power switch off momentarily then back to on and touch Start. If error persists call for service.
E23	The high lifter sensor was active when it should not be activated.	Check for a package jam. Remove all packages. Turn wrapper power switch off momentarily then back to on and touch Start. If error persists call for service.
E24	The high lifter sensor was not active when it should be activated.	Check for a package jam. Remove all packages. Turn wrapper power switch off momentarily then back to on and touch Start. If error persists call for service.
E31 E32 E33 E34 E35 E36 E37	Center clamp malfunction.	Remove jam and any packages. Turn wrapper power switch momentarily off then back to on and touch Start. Check that film is threaded properly. If error persists call for service.

Code	Description	Solution
E41 E42	Side clamp malfunction.	Remove any jammed packages. Turn wrapper power switch off momentarily then back to on and touch Start. Check that film is threaded properly. If error persists call for service.
E60	Two packages detected entering the machine.	Insert only 1 package at a time. Reposition packages. If error persists call for service.
E61	Package is too large	Refer to the Tray Reference Chart in Chapter 4 or on the wrapper. Change feed direction (landscape/portrait) if necessary. Make sure trays are within recommended specifications. Packages could be slipping on the belts or dragging on a riser that is not fully inserted. Clean the infeed belts and photoeyes. Switch to a smaller or different tray. If error persists call for service.
E62	Package is too small	Clean all infeed photoeyes. Switch to a larger tray. If error persists call for service.
E63	Infeed Photoeyes Blocked or Dirty	Clean both top and bottom horizontal and left and right vertical photoeyes. Turn wrapper power switch off momentarily then back to on and touch Start. If error persists call for service.
E64	Package is too tall	Maximum height is 5.1". Check height of tray contents or repack.
E65	Package not sensed by Package Measurement Photoeyes	The Package Detection Photoeye was activated, but, no package was detected by the measurement photoeyes. The package was either not conveyed into the wrapper or the photoeyes are malfunctioning. Clean both top and bottom horizontal and left and right vertical photoeyes with a clean cloth. Also clean the reflector on the scale platter (see photo to the left). Turn wrapper power switch off momentarily then back to on and touch Start. If error persists call for service.
E66	Package Detection Photoeye is Always Activated	Remove package or debris and clean package position photoeye. Clean the reflector on the scale platter (see photo to the left). Turn wrapper power switch off momentarily then back to on and touch Start. If error persists call for service.



Clean the reflector on the scale platter. If it is dirty or covered with any debris, this can cause E65 or E66 errors.

Code	Description	Solution
E67	Package was not aligned properly, too far left or too far forward.	The package was not positioned correctly under infeed start photoeye. Make sure packages are positioned under infeed photoeye, against the guide on right side of infeed, and not too far into the machine. If error persists, clean photoeyes and retry. Call for service if unable to resolve.
E71 E72 E74	Rear Side Clamp Malfunction	Clear and remove any package jam if one exists. Re-thread and cut film if needed. Press start and retry operation. Turn wrapper power switch off momentarily then back to on and touch Start. If error persists call for service.
E75 E76	Front side clamp malfunction.	Check side and center clamp area to verify it is clear and remove package jam if one exists. Re-thread and cut film if needed. Turn wrapper power switch off momentarily then back to on and touch Start. If error persists call for service.
E78	Rear Side Clamp Malfunction	Clear and remove any package jams if one exists. Re-thread and cut film if needed. Press start and retry operation. Turn wrapper power switch off momentarily then back to on and touch Start. If error persists call for service.
E85	Confirm infeed is clear. Press start	Occurs as a manual verification that a package is not under the package detection photoeye after an infeed error. If error persists call for service.
E86	Infeed Safety Photoeye Did Not Function	The Infeed Safety Photoeye did not function for a package that entered the machine. Clean both photoeyes and mirrors. Turn wrapper power switch off momentarily then back to on and touch Start. If error persists call for service.
W89	Low Internal Temperature	The internal temperature is below required settings. When first turning the machine on, the temperature may take several minutes to heat up to the preset operating temperature. You may see some variations in wrap quality. If error persists call for service.
W90 W91 W92	Sealing Plate Malfunction	You may see some variations in wrap and sealing quality. Turn wrapper power off and then back on. If error persists call for service.
W93	Internal Heater not Functioning	You may see some variations in wrap and sealing quality. Turn the wrapper power off then back to on. If error persists, call for service.

Code	Description	Solution
W94	Sealing Plate Exceeding Temp Limit	The film on the bottom of the tray may melt. Do not touch sealing belt area. Turn wrapper power switch off momentarily then back to on and touch Start. If error persists, call for service.
W95	Sealing Plate Hotter Than Preset	The film on the bottom of the tray may melt. Do not touch sealing belt area. Turn wrapper power switch off momentarily then back to on and touch Start. If error persists, call for service.
W96	Internal Temperature Probe Malfunction	Commander will continue to weigh, wrap and label packages, but you may see some variations in wrap and sealing quality. If error persists call for service.
W97	Machine Voltage Is Low	Make sure incoming power cord to Commander is plugged in correctly. Have the maintenance department check incoming power. If error persists call service.
W98	Machine Forced Into Slow Safety Speed	Commander is operating at a reduced speed. Turn wrapper power switch off momentarily then back on and touch Start. If error persists call service.
W99	One or More Photoeyes Malfunctioned	You may see some variations in wrap quality. Clean both top/bottom horizontal and left/right vertical photoeye. Turn wrapper power switch off momentarily then back to on and touch Start. If error persists call service.

Commander Help

The Commander is equipped with an on-screen help system to assist operators with basic system operation instructions. The help system will also provide simple troubleshooting guides and cleaning instructions.

To activate the help system, press the **Help** button on the controller home screen.

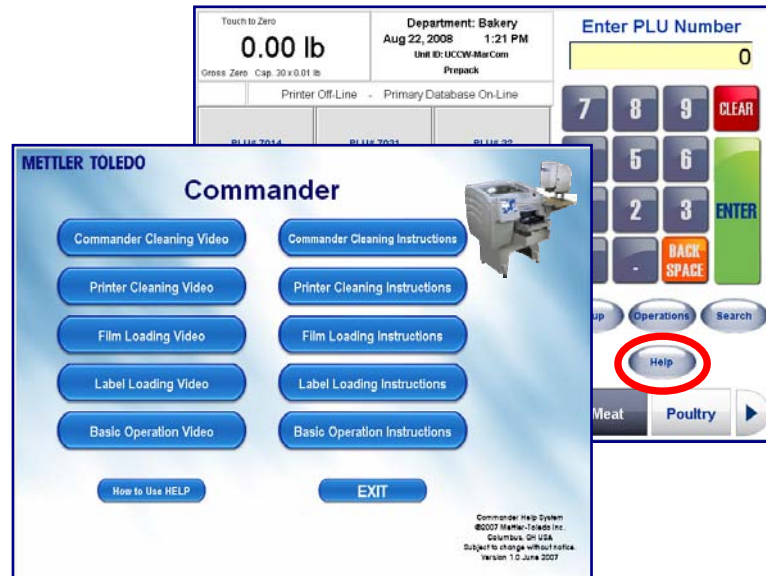

Remote Access Assistance

A technician or help desk person can log in remotely to the Commander to assist in tracking down the problem without physically being there. They can perform remote troubleshooting and view error logs that can speed up the resolution of any issues. This can be performed using standard Windows® or Linux tools.

METTLER TOLEDO

For your notes

9

Extra Programs

Task Manager

Overview

Task manager is an in-store scheduling and status verification program (Windows® only) that is meant to assist in the operation of the Meat room, or other departments, for better operational efficiency and tracking of important activities. These activities include such tasks as:

- Cleaning and sanitizing work surfaces, floors, etc
- Activities related to processing
- Maintenance of the equipment
- Maintaining the inventory of supplies
- Other activities related to hygiene of the environment.

Personnel using the Task Manager are identified by their login username and password. Task manager is used to store tasks that are to be done on a regular basis. The manager can create tasks at the controller. These tasks will then be displayed on the day that they are scheduled. The operator can mark the tasks complete after the task is done. If the task was not completed on the date assigned, it will show an "Overdue" status. The operator can also select a status to show a task could not be completed and then document the reason (example: correct part not available). Details of "Completed" tasks' and tasks "not done" are stored in databases.

Requirements and Installation

Application requires JAVA Runtime v 1.5 or above to run. SYBASE version 9.0.2 or above is also required. The Installation package will check for both JAVA and SYBASE Database. The Installation package will check for both JAVA and SYBASE, but has the capacity to install only the SYBASE Database. It expects that the JAVA language version 1.5 or above is already installed on the machine and the installation will be aborted otherwise to allow the user to install JAVA 1.5 or above.

The SYBASE dbengine 9.0 needs to be installed specifically in the path C:\Program Files\Mettler Toledo\Service\Sybase ASA 9.0\win32. The installation package will do this if it does not find the SYBASE dbengine 9.0 in the required path (after confirmation from the user).

The Installation package will then install the Task Manager in the Start Up folder of the scale. This will make the application active when the scale is started.

Starting Task Manager

When the application starts it tries to connect to the SYBASE Database through the default port number. If this port is being used by any other application then SYBASE returns an error that the port is in use. The user is requested to click on the OK button of this dialog box. The application is designed to also connect through an alternative port number to the SYBASE database.

Initial screen: Login screen – The user logs in with his name and password. The default user's name is admin and the password is admin.

Note: Each user is assigned two sets of administrative rights – Task specific (Add task / Delete task / Edit task / Complete task) and User Specific (Add user/ Delete user / Edit user details). By default all users have the right to complete a task.

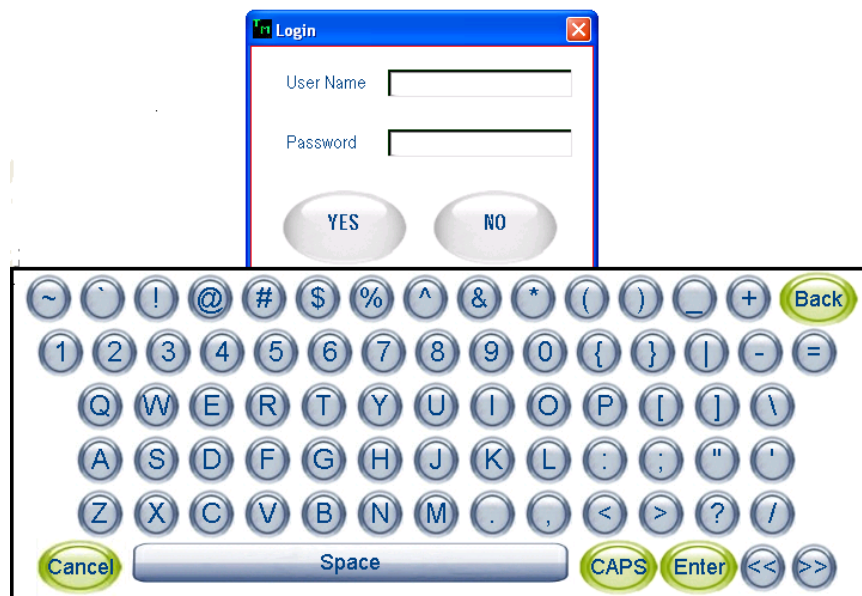

Active Task View

After successful login, the Task Manager displays the Active Task View screen. This screen shows the list of tasks to be done for the day. All tasks for the day are shown regardless of which operator has logged in. The details shown are:

- Task name
- Task Description
- Status
- Priority
- Date
- Time Scheduled for.

The tasks are retrieved from the Master Task database by comparing the scheduled date of the task with the current date. The creation of the Active task list is done when the application is started and also at 12:01 AM every day. The tasks are shown sorted by Date and then Time.

Task	Description	Priority	Status	Date	Time
MONTHLYDATE	Audit	Normal	To be done	04-25-08	11:17:00
ONCE	Safety	Normal	To be done	04-25-08	11:19:00
WEEK DAY	Wrapper Cleaning	Normal	To be done	04-25-08	11:19:00
MONTHLYDAY	Safety 2	Medium	To be done	04-25-08	11:19:00
WEEKLY	Database log	Medium	To be done	04-25-08	11:19:00
NEW TASK		Normal	To be done	04-25-08	11:37:00

The buttons shown in this screen are:

- Add
- Edit
- Complete (This button changes to the "To be done" button for an Undo feature)
- Cancel (This button changes to the "Restore" button for an Undo feature)
- Cannot Do
- Report
- Quit

The Add, Report, and Quit buttons show descriptions in green indicating an active status. The Edit, Complete, Cancel, and the "Cannot Do" buttons are grey showing an inactive status. When a pending task is selected from the Active Task view screen, the Edit, Complete, Cancel, and Cannot Do buttons are then activated.

If the wrong task is accidentally completed, there is an undo feature in the task manager. When selecting an already "Completed" task or a task already designated as "Cannot Do" from the Active Task View screen, the "Complete" description on the button will change to the "To be Done" description. If this button is pressed, the Task will revert back to a pending status. When selecting a task that has already been cancelled from the Active Task View screen, the "Cancel" description on the button will change to the Un-cancel description. If this button is pressed, the task will be reactivated.

In addition to the buttons on the bottom of the page, there are two icons on the top panel of the Active Task View screen. When "Admin" (with the face) is clicked, the user database is opened. The options are to add a new user with corresponding password, modify an existing user and password, or delete an existing user. When adding a new user, the "rights" of the user is specified at this time. When a user logs on that has only Task specific rights, than that user is only allowed to change his/her own password.

When the icon on the right side ("I" icon) is clicked, information about the Task Manager Application is displayed including the version number.

When clicking in the description field of a task, a pop up displays the complete description. Touching the Close button will close the description pop up.

Add Task

This screen is used to add a new task. Enter the Task name, the Task description, the Priority of the task, the Schedule of the task, and the Time at which the task is to be done. By default the time specified for a new task is 12:00. To modify, touch the time box.

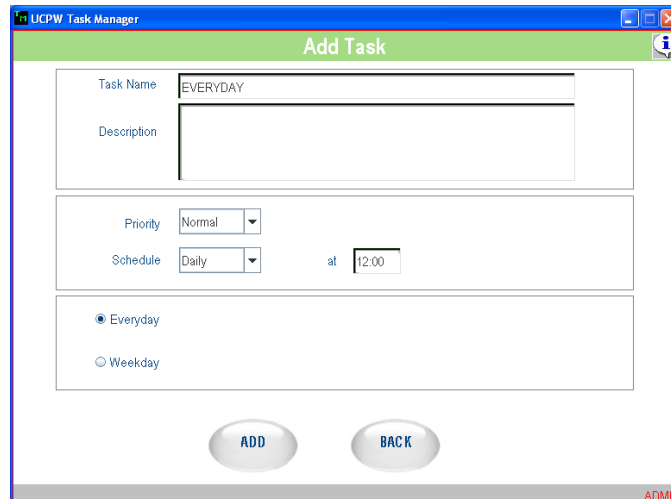

Enter Task Name and the Task Description through the QWERTY keyboard that appears on the screen or through an external keyboard.

While using the QWERTY keyboard entry in a particular field, the entry is completed by clicking on the ENTER key.

While using the PC keyboard, move from the Task name field to the Task description field by using the TAB key. To move from the Task description to the Task, use the Control and TAB keys.

You can alternate between the QWERTY keyboard and the PC keyboard to enter data in a field. After entering data through the QWERTY keyboard press ENTER. The data will be shown in the corresponding field in the Add Task screen. Then data can be entered through the PC keyboard. To again enter data through the QWERTY keyboard, touch in the field and the application will show the QWERTY keyboard screen for further entry.

Press the CANCEL key and the application will close the QWERTY keyboard screen. The Task name can be of 20 characters length, while the Task description can be of 2000 characters length.

To designate the priority level of the task, select High, Medium or Normal. The default priority is normal. To change the priority to Medium or High, click arrow. If a task is not completed in a set time frame, the priority level can be escalated. See the Priority Escalation section for further details.

Choose the Schedule of the task by clicking on the triangular button provided next to the Schedule field to display a drop down menu. The options given are:

Once - The task is done only once. The date and time are specified for this task. The date is specified by the 'date' field. A date chooser is displayed where the user can select the year, month, and the date of the month. Similarly the time is chosen by clicking the 'time' field and selecting the hour, minute and the second from a Time chooser that is displayed. This task will be shown in the Active Task view screen for the day on which it is scheduled. If it is marked as completed on the date it was scheduled, it will not be shown again. If the task is carried over to the next day, it will be shown again each day with a Pending status (Overdue) until the task is marked as Completed.

The screenshot shows a web-based form titled "Add Task" within a window labeled "UCPW Task Manager". The form is organized into several sections. The top section contains a "Task Name" field with the text "ONCE" and a larger "Description" text area below it. The middle section features a "Priority" dropdown menu set to "Normal" and a "Schedule" dropdown menu set to "Once", followed by an "at" label and a time input field showing "12:00". The bottom section has a "Date" field with the value "6-19-2008". At the bottom of the form are two large, rounded buttons labeled "ADD" and "BACK". A small "ADMIN" label is visible in the bottom right corner of the window.

Daily - This has two options – Daily or on Weekdays.

Every day – The task is done every day, 7 days a week. The time is specified for this task. The time is chosen by clicking or touching the 'time' field and selecting the hour, minute and the second from a Time chooser that is displayed. If a daily task is not completed on the scheduled date, it will be recorded directly to the "Task not Done" database. Since the daily task is regenerated every day, the previous day task that was incomplete will not be shown on the next day as pending. Thus the same task will not be shown twice on one day.

Weekdays – The task is done on all weekdays. (Weekdays are taken as Monday to Friday). This task is shown on all weekdays. As a new instance of this task is generated for the next day, an incomplete task is never shown again marked with a status as Pending. An incomplete task at the end of the day is added to the Task Not Done Database. This applies to tasks scheduled for the last of the weekdays (Friday) also.

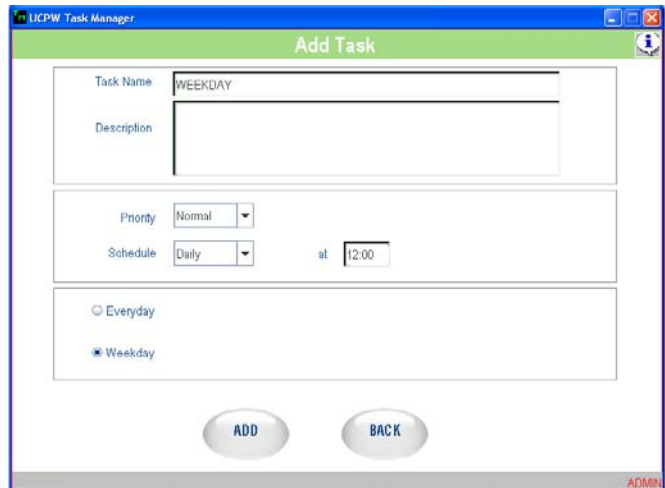

Weekly – This task is done once a week, every week. The day of the week and the time of the task are specified by the user. The user chooses the particular day of the week by touching / clicking the triangular button next to the day field. Time is chosen using the time chooser.

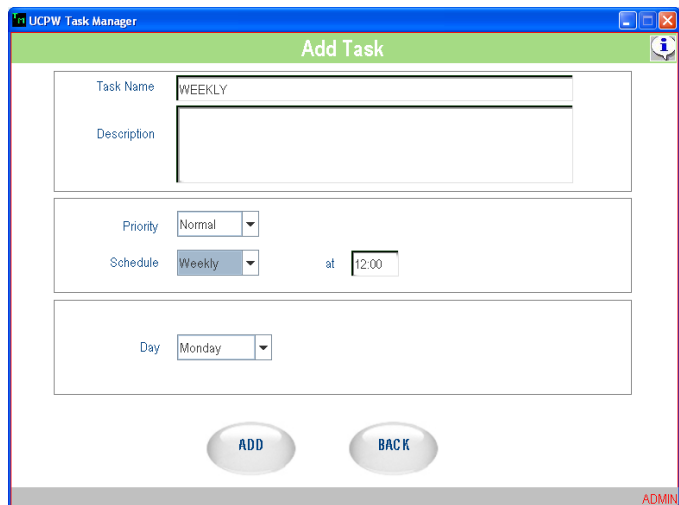

When the scheduled day of the week arrives the task is shown in the Active Task list. If the task is marked as completed then the task is added to the Completed task database. If the task is not marked as completed on the scheduled day then the task will be shown on the next day's active task list with the status marked as Pending (Overdue). This will continue until the task is marked complete, or marked "Can not Do" or the following week's same task gets scheduled. In the last case the task is moved to the Task Not Done Database.

Monthly - This task is done once a month, every month. This can be scheduled as a day of the week or as a date of the month.

For Day of week option, first choose the day of the week then select the week. Time is chosen using the time chooser.

When the scheduled day of the week arrives the task is shown in the Active Task list. If the task is marked as completed then the task is added to the Completed task database.

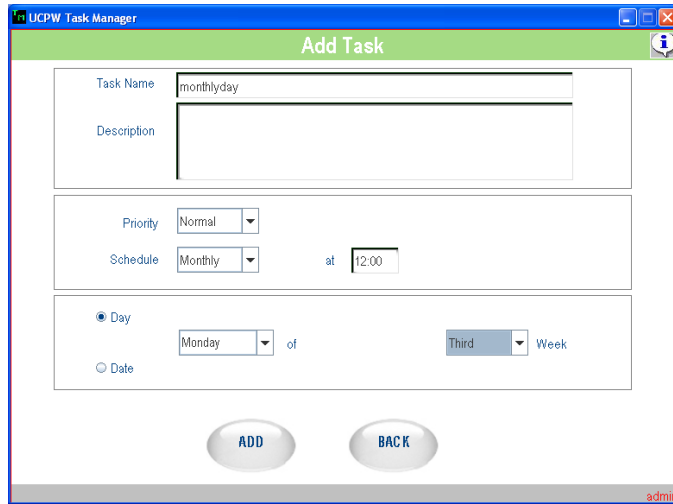

To use the date option and then chooses the date of the month using the date chooser that appears when the focus is brought to the date field. Time is chosen using the time chooser.

When the scheduled date of the month arrives the task is shown in the Active Task list. If the task is marked as completed then the task is added to the Completed task database.

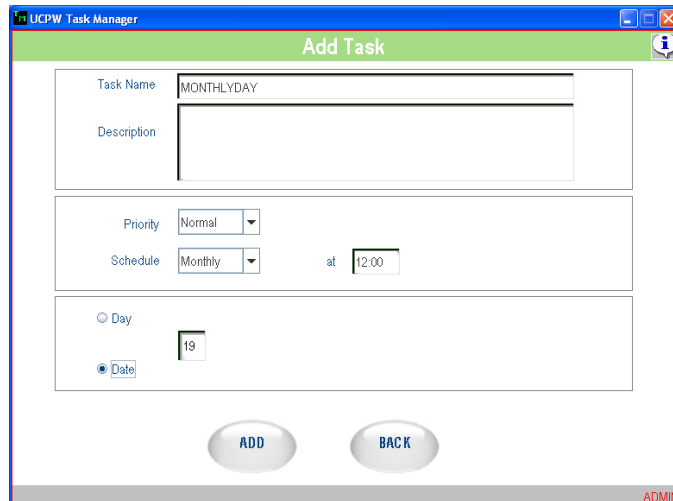

In both the cases, if the task is not marked as "Completed" or "Cannot Do" on the scheduled day then the task will be shown on the next day's active task list with the status marked as Pending (Overdue). This will continue until the task is marked complete or the following month's same task gets scheduled. In the latter case the task is moved to the Task Not Done Database.

If the scheduled date of the new Task is the current date, then it is immediately displayed in the Active Task List.

More than one task can be added in a session. After entering the details of each task click the OK button. This will save the details of the task to the Master Task Database. Click the Back button before the OK button it will cancel the entry of details for the task and take the user back to the Active task view screen. This is done after confirmation is received from the user that the task details need not be saved.

Edit Task

To edit a task, select the task on the Active Task Viewer screen.

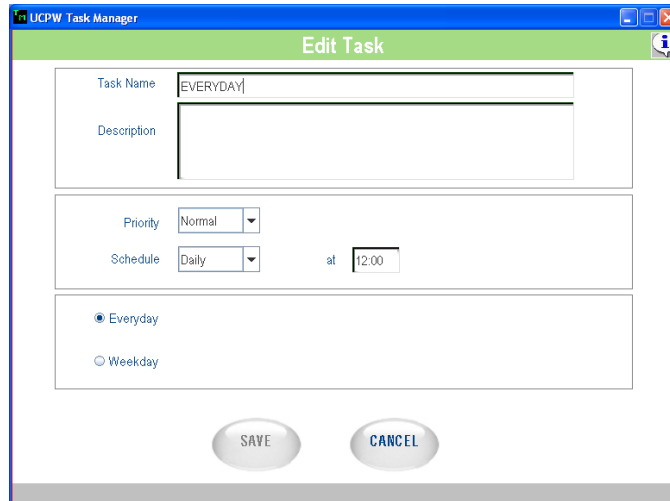

After choosing the task, click the Edit button. The task details are then shown and changes can then be made. Only a task that is currently scheduled, an active task, can be edited. A completed, Cannot Do or Canceled task cannot be chosen for editing.

The edited task is entered in the database on a new line similar to a new task.

Task Complete

The Complete button is enabled only when a task is selected.

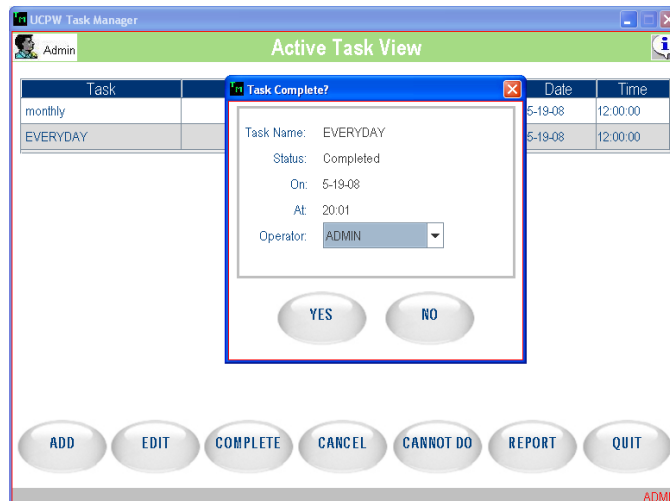

Choose a task by clicking on the task row. If the task has been completed, click the Complete button. A window opens that shows the task name with the status as completed. The current date and time are also shown along with the operator name. If the user clicks on the OK button, then the task status is changed as Completed in the Task view screen and the task is added to the Completed Task table.

Cancel a Task

This button is enabled only when a task is selected.

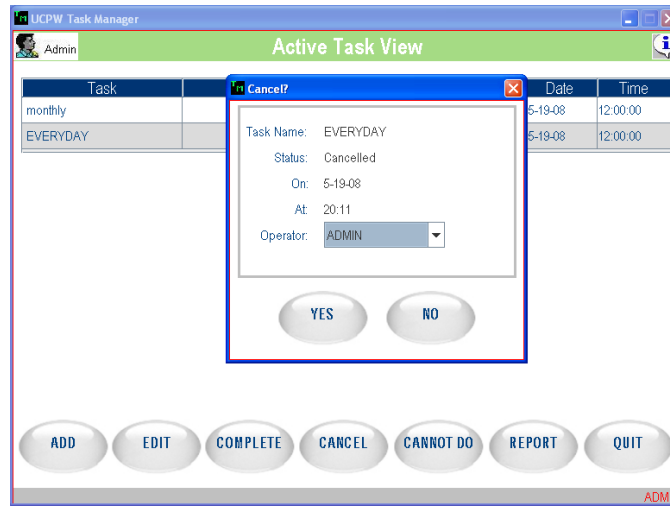

Choose a task by clicking on a particular task row. To remove the task from the task list, click the Delete button. A window opens, which asks for confirmation of the deletion. If the OK button is clicked, the task status is changed to Deleted in the Task view screen. When the application closes the task is deleted from the Master Task table. It will not be shown on succeeding days. Completed tasks cannot be deleted.

An option to undelete the task is also provided. When a currently deleted task is selected, the button Delete changes to Undelete. Clicking the Undelete button will change the task back to a To Be done task.

Reports

Reports can be generated using the filters of date range, status (to be done, not done, completed), and priority (high, medium, normal). Reports can be designated to view past items and preview future tasks for planning.

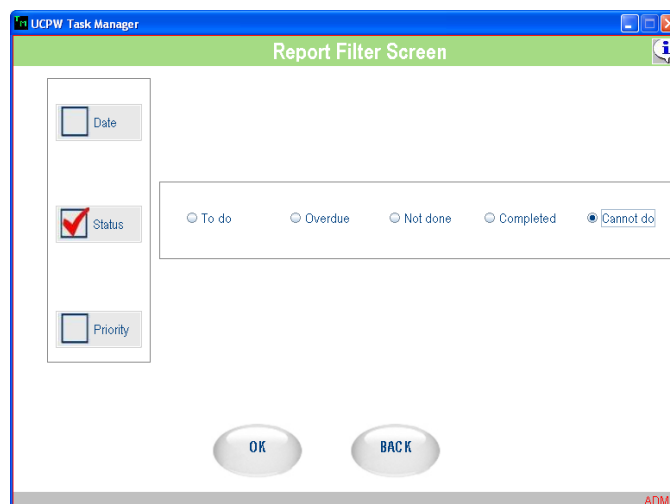

The Task name, description and date scheduled are the other fields displayed in the report viewed on the UCPW screen. On clicking OK, the application shows the data gathered in another screen. The values for the filters are shown on top and the record data are shown in a table.

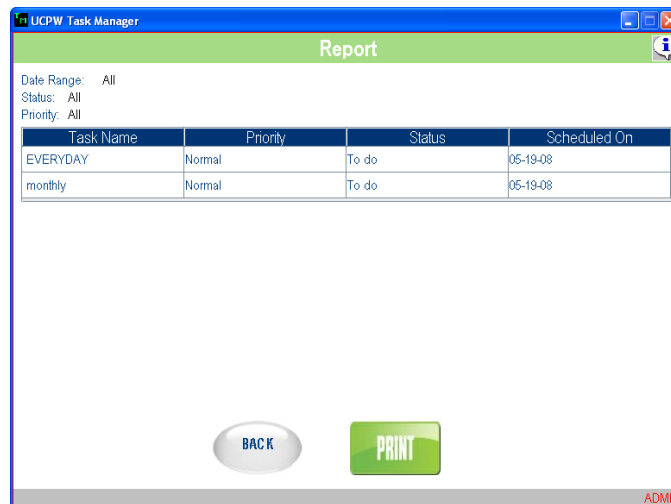

This report can be printed through the HTML print screen that is shown when the PRINT button is clicked.

Task Report
Report Date : 5-19-2008
Date Range : All
Status : All
Priority : All

Task Name	Priority	Status	Scheduled On
EVERYDAY	Normal	To do	05-19-08
monthly	Normal	To do	05-19-08

Priority Escalation

When a scheduled task is not done, its priority is escalated. A task marked as 'Cannot do' is also considered as finished. A High priority task remains High priority.

A Medium priority task moves to High priority when it crosses half its lifetime. This means that a weekly Medium priority task will move to High priority when it has remained pending for 4 days. Similarly, a monthly Medium priority task will move to High priority when it has remained pending for 16 days.

A Normal task moves to Medium priority when it crosses half its lifetime and moves to High priority when it crosses half of the remaining lifetime. This means that a weekly Normal priority task will move to Medium priority when it has remained pending for 4 days and will move to High priority when it has been pending for 5 days. Similarly, a monthly Normal priority task will move to Medium priority when its status has remained pending for 16 days, and will move to High priority when it has been pending for 23 days.

Tasks that are scheduled for a One time (once) escalate their priority the next day.

Tasks that are scheduled for 'every day' and for 'weekdays' do not escalate their priority as they are replaced by a new instance of the task on the next day.

Production Reports

Main Screen

Shown below is the main screen of the Production Reports application (Windows® only).



Custom Production Report: When selected, this report lists all the produced items for a particular date range. The report can be filtered by Operator, Department Number and by PLU number.

Daily Production Trend Report: When selected, this report summarizes all the items produced for the selected 4 weeks. This report is useful to view the production trend by using weight or by using value of each item.

Price Override Report: When selected, this report lists all the items for which Price have been overridden in a particular date range.

Detailed PLU Report: When selected, this report summarizes the production details of a selected item. The summary is done for the selected 4 weeks. The summary consists of Production based on Units, Weight and value. This report also lists the number of Price overrides done during the period.

Department Summary Report: When selected, this report summarizes the production details of all the items in a selected department. The summary is done for the selected 4 weeks. The summary consists of Production based on Units, Weight and value. This report also lists the number of Price overrides done during the period.

Setup: When selected, the user can modify some of the settings like Header, Footer, Selected Columns etc., for all the reports. The user can also modify the Database connection settings. The Production reports can use both the local and remote database for producing reports.

Custom Production Report

Dept	Op	PLU	Description	Total Items	Total Wgt	Avg Wgt	Retail Value	Avg Value
1	0	9415	BEEF LIVERS	656	898.500	1.370	\$733	\$1.12
1	0	895	FROZEN CAT ...	78	85.900	1.101	\$343	\$4.40
1	0	998	SMOKED HE...	11	11.560	1.051	\$74	\$6.72
1	0	9255	BONELESS R...	656	1738.250	2.650	\$3549	\$5.41
1	0	920	FROZEN LOB...	1	1.030	1.030	\$9	\$9.26
1	0	9440	BEEF BACK RIBS	61	81.730	1.340	\$154	\$2.53
1	0	514	LEG OF LAMB ...	21	104.460	4.974	\$455	\$21.64
1	0	60518	BONELESS L...	4	10.240	2.560	\$49	\$12.26
1	0	9473	PORK RIB EN...	14	27.950	1.998	\$41	\$2.93
1	0	9572	COUNTRY ST...	320	770.370	2.407	\$1478	\$4.62
1	0	825	BATTERED G...	50	47.930	0.959	\$191	\$3.82
1	0	9173	BONELESS C...	175	403.820	2.308	\$1279	\$7.31
1	0	9711	PORK HEARTS	113	165.300	1.463	\$147	\$1.30
1	0	9461	PORK SHOUL...	88	227.870	2.589	\$322	\$3.66
1	0	436	VEAL NECK B...	30	44.770	1.492	\$117	\$3.91
1	0	9672	FRESH PORK...	259	474.930	1.833	\$1034	\$3.99
1	0	9290	BONELESS B...	209	1004.870	4.808	\$3102	\$14.84
1	0	60	CHICKEN WINGS	286	472.260	1.651	\$1083	\$3.79
1	0	9703	PORK EARS	63	94.690	1.503	\$158	\$2.51
1	0	892	FROZEN CLE...	40	36.140	0.904	\$126	\$3.15
1	0	503	LAMB CENTE...	103	98.360	0.955	\$884	\$8.58
1	0	9901	SEASONED S...	5	8.590	1.718	\$11	\$2.22
1	0	9472	PORK LOINE...	312	841.440	2.956	\$1148	\$3.67

Figure 1: Custom Production Report

When this report is selected, the screen above with the headers are shown.

Start Date: When selected, a popup calendar is to be shown from which the user can select the starting date. Default = Yesterday Date.

End Date: When selected, a popup calendar is to be shown from which the user can select the ending date. Default = Yesterday Date.

Department Number: When the Dept # header is tapped (Pressed), the following option screen is shown:

Figure 2: Filter Window

The *Variable Name* is the name of the field for which the filter is to be done (example: Depart Number, Operator, PLU etc).

The *Condition* contains the filter conditions which is to be applied to the variable (example: '=', '>', '<', '>=', '<='). For Alpha variables, the condition is always '='. Other conditions apply only to the numeric fields.

The *Value* is a list of values from which the user can select. (example: Department Numbers). The value also contains *All*, for selecting all the department number (default)

The report can be sorted by Ascending or Descending Department Number.

Group Number: When the user taps the Grp# header, the window (Figure 2) is shown to filter the required Group numbers.

Operator Number: When the user taps the Op.# header, the window (Figure 2) is shown to filter the required Operators.

PLU Number: When the user taps the PLU# header, the window (Figure 2) is shown to filter the required PLUs..

Description: When the user taps the Description header, the window (Figure 3) is shown to select the required description.

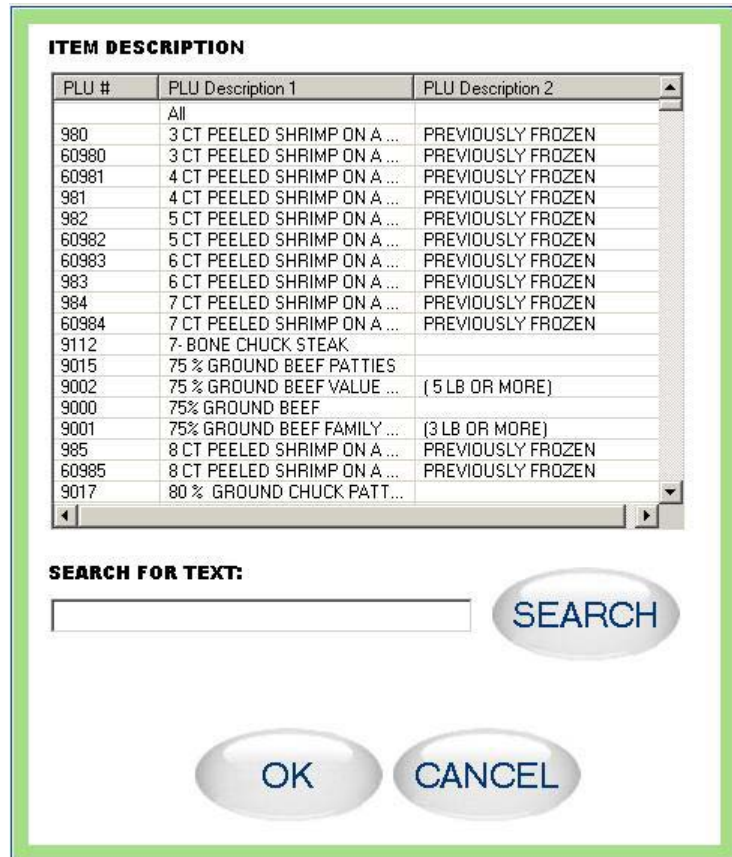

Figure 3: Select Item Description

The List window contains all the Item Description, pertaining to the PLU# selected or all the Item description if PLU# is "All". A Search option is provided to search an Item Description. By typing the text in the Search window and pressing the Browse button (...), the List window will show the filtered Item description.

RUN REPORT: Once all the filter and selection criteria is completed, the user has to press "RUN REPORT" button. Now the report will be generated and displayed in the list window.

PRINT: Once the report is generated and displayed, by pressing this button, the report is printed on to a connected printer.

SAVE: By pressing this button, The generated report can be saved to a Excel or a HTML file.

Daily Production Report



Figure 4: Daily Production Trend Report

Start Date: When selected, a popup calendar is to be shown from which the user can select the starting date. Default = Yesterday Date.

End Date: When selected, a popup calendar is to be shown from which the user can select the ending date. Default = Yesterday Date.

Report For: By selecting a particular day, the report is generated for the day for the past 4 weeks.

Report By: By selecting "Weight", the report displays production trend based on Weight and if "Units" is selected, the production trend is based on the number of units produced for the particular period.

Department Number: When the Dept # header is tapped (Pressed), the option screen (Figure 2) is shown.

PLU Number: When the user taps the PLU# header, the window (Figure 2) is shown to filter the required PLUs..

Description: When the user taps the Description header, the window (Figure 3) is shown to select the required description.

RUN REPORT: Once all the filter and selection criteria is completed, the user has to press "RUN REPORT" button. Now the report will be generated and displayed in the list window.

PRINT: Once the report is generated and displayed, by pressing this button, the report is printed on to a connected printer.

SAVE: By pressing this button, The generated report can be saved to a Excel or a HTML file.

Price Override Report

Dept	Op	Date	Time	PLU	Description	Old Price	New Price	Change
1	0	02-01-2008	08:00:59	9560	LIGHT PORK SPAR	\$1.79	\$3.49	\$1.70
1	0	02-01-2008	08:38:49	9058	BULK MILD ITALIAN...	\$2.59	\$1.89	-\$0.70
1	0	02-01-2008	11:15:58	9267	BRASCIOLE	\$4.99	\$4.98	-\$0.01
1	0	02-01-2008	11:16:02	9267	BRASCIOLE	\$4.99	\$4.98	-\$0.01
1	0	02-01-2008	13:17:50	9570	BABY BAK RIBS	\$3.98	\$2.99	-\$0.99
1	0	02-01-2008	14:54:36	9049	GROUND TURKEY	\$2.50	\$2.49	-\$0.01
1	0	02-01-2008	15:06:55	912	BEEF TAMALES	\$2.99	\$2.79	-\$0.20
1	0	02-01-2008	15:38:06	9434	MARROW BONES	\$0.99	\$1.19	\$0.20
1	0	02-02-2008	11:10:25	9148	BONELESS CHUC...	\$2.79	\$3.29	\$0.50
1	0	02-02-2008	11:14:32	9001	75% GROUND BEE...	\$1.99	\$1.69	-\$0.30
1	0	02-02-2008	11:15:35	9001	75% GROUND BEE...	\$1.99	\$1.69	-\$0.30
1	0	02-02-2008	17:06:41	9001	75% GROUND BEE...	\$1.99	\$1.89	-\$0.10
1	0	02-02-2008	17:07:50	9001	75% GROUND BEE...	\$1.99	\$1.89	-\$0.10
1	0	02-02-2008	13:56:53	70	CHICKEN WINGETTES	\$2.50	\$2.49	-\$0.01
1	0	02-02-2008	15:46:37	9570	BABY BAK RIBS	\$3.98	\$3.69	-\$0.29
1	0	02-02-2008	15:47:07	9570	BABY BAK RIBS	\$3.98	\$3.69	-\$0.29
1	0	02-02-2008	15:49:29	9570	BABY BAK RIBS	\$3.98	\$3.69	-\$0.29
1	0	02-02-2008	16:04:10	9078	FRESH BRATWURST	\$2.50	\$2.49	-\$0.01
1	0	02-03-2008	12:19:59	601	FROZEN BUTTER F...	\$2.99	\$1.99	-\$1.00
1	0	02-03-2008	12:36:55	961	FROZEN CATFISH...	\$0.00	\$2.39	\$2.39
1	0	02-03-2008	12:38:19	803	FROZEN MACO SH...	\$4.49	\$4.98	\$0.49
1	0	02-03-2008	12:39:41	803	FROZEN MACO SH...	\$4.49	\$4.98	\$0.49
1	0	02-03-2008	12:53:06	80	CHICKEN LEG QUA...	\$1.19	\$0.79	-\$0.40

Figure 5: Price Override Report

Start Date: When selected, a popup calendar is to be shown from which the user can select the starting date. Default = Yesterday Date.

End Date: When selected, a popup calendar is to be shown from which the user can select the ending date. Default = Yesterday Date.

Department Number: When the Dept # header is tapped (Pressed), the option screen (Figure 2) is shown.

Operator Number: When the user taps the Op.# header, the window (Figure 2) is shown to filter the required Operators.

PLU Number: When the user taps the PLU# header, the window (Figure 2) is shown to filter the required PLUs..

Description: When the user taps the Description header, the window (Figure 3) is shown to select the required description.

RUN REPORT: Once all the filter and selection criteria is completed, the user has to press "RUN REPORT" button. Now the report will be generated and displayed in the list window.

PRINT: Once the report is generated and displayed, by pressing this button, the report is printed on to a connected printer.

SAVE: By pressing this button, The generated report can be saved to a Excel or a HTML file.

Detailed PLU Report

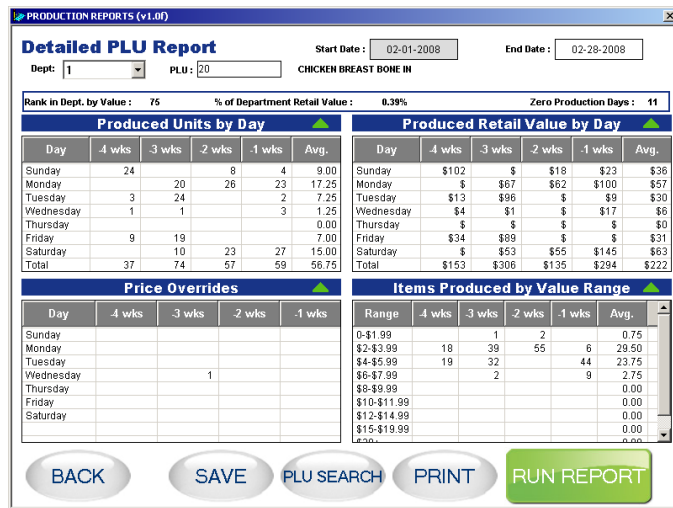

Figure 6: Detailed PLU Report

Start Date: When selected, a popup calendar is to be shown from which the user can select the starting date. Default = Yesterday Date.

End Date: When selected, a popup calendar is to be shown from which the user can select the ending date. Default = Yesterday Date.

Department Number: When the Dept # header is tapped (Pressed), the option screen (Figure 2) is shown.

PLU Number: When the user taps the PLU# header, the window (Figure 2) is shown to filter the required PLUs.

PLU SEARCH: When this button is, the search window (Figure 3) is shown to select the required description. The user can select a particular PLU from the list box.

RUN REPORT: Once all the filter and selection criteria is completed, the user has to press "RUN REPORT" button. Now the report will be generated and displayed in the list window.

PRINT: Once the report is generated and displayed, by pressing this button, the report is printed on to a connected printer.

SAVE: By pressing this button, The generated report can be saved to a Excel or a HTML file.

NOTE: The Value range can be modified from "Setup" menu for the "Items Produced by value range" as per user requirement.

Department Summary

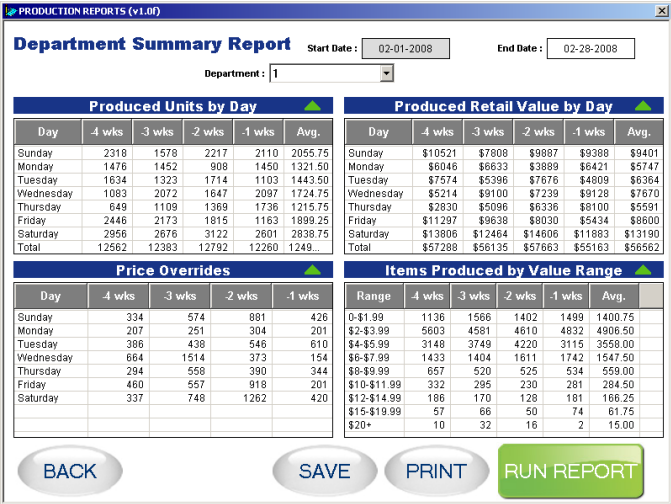

Figure 7: Department Summary

Start Date: When selected, a popup calendar is to be shown from which the user can select the starting date. Default = Yesterday Date.

End Date: When selected, a popup calendar is to be shown from which the user can select the ending date. Default = Yesterday Date.

Department Number: When the Dept # header is tapped (Pressed), the option screen (Figure 2) is shown.

RUN REPORT: Once all the filter and selection criteria is completed, the user has to press "RUN REPORT" button. Now the report will be generated and displayed in the list window.

PRINT: Once the report is generated and displayed, by pressing this button, the report is printed on to a connected printer.

SAVE: By pressing this button, The generated report can be saved to a Excel or a HTML file.

NOTE: The Value range can be modified from "Setup" menu for the "Items Produced by value range" as per user requirement.

Setup: Configuring Reports

The displayed fields in the report can be modified from the "Setup" menu. The configuration screen is shown in Figure 4.

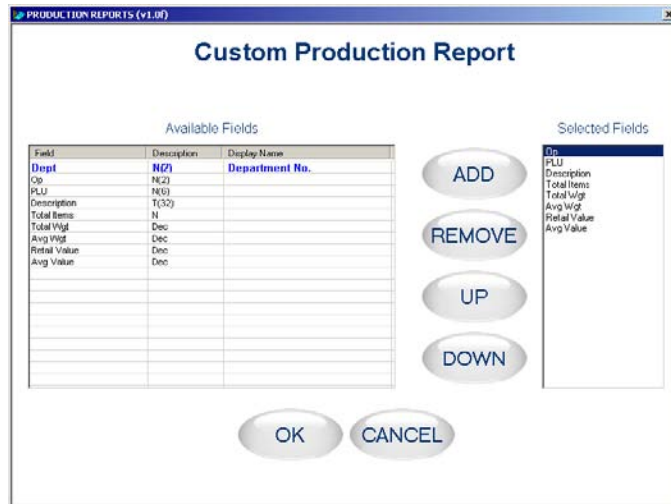

Figure 8: Reports Configuration Screen

Available Fields: This window lists the fields that are available in corresponding Report.

Selected Fields: This window lists the fields that are selected by the user to be displayed in the corresponding Report.

Display Name: With this field, the user can modify the title of the selected field.

ADD: When this button is pressed, the current field is selected to be displayed in the report.

REMOVE: With this button, the selected field is removed from the report.

UP DOWN: With this button, the selected field can be moved up or down.

OK: By pressing this button, the changes are saved.

CANCEL: By pressing this button, the changes are discarded.

Some of the reports like Department Summary and Detailed PLU report, has more than one screen for configuration. The following figures shows a typical Department Summary configuration.

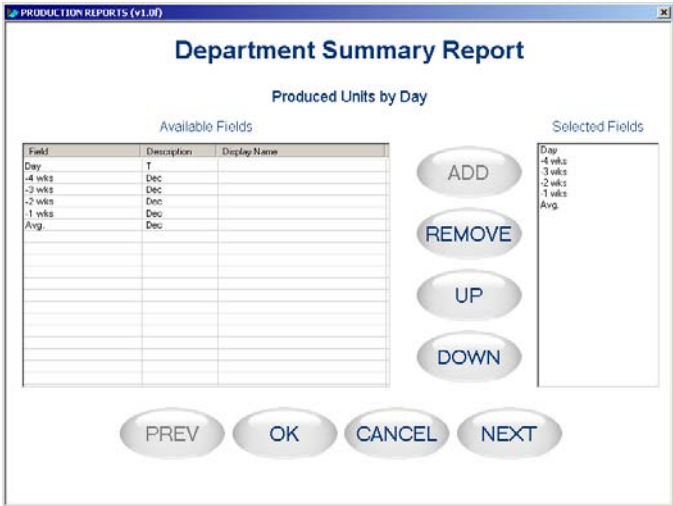

Figure 9: Configuring fields for "Produced Units by day"

NEXT: By pressing this button, the next configuration (Figure 10) screen is shown.

PREV: Not available (disabled) for this configuration Screen.

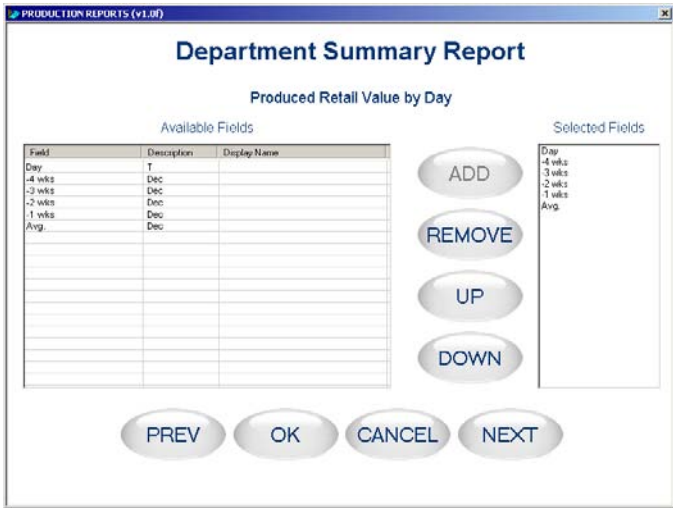

Figure 10: Configuring fields for "Produced Retail value by day"

NEXT: By pressing this button, the next configuration (Figure 11) screen is shown.

PREV: By pressing this button, the previous configuration (Figure 10) screen is shown.

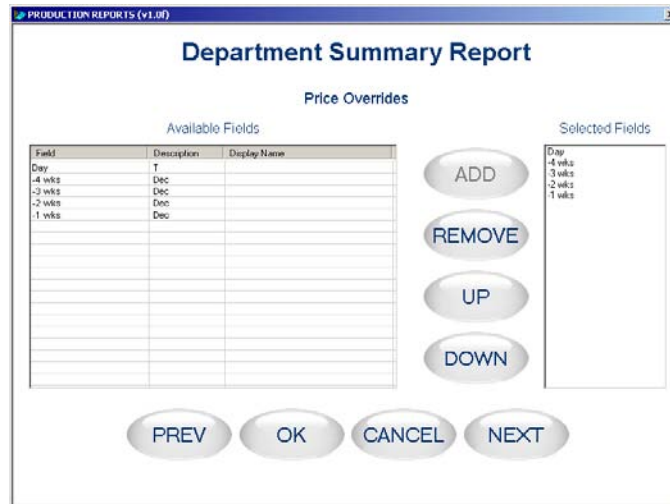

Figure 11: Configuring fields for "Price Overrides"

NEXT: By pressing this button, the next configuration (Figure 12) screen is shown.

PREV: By pressing this button, the previous configuration (Figure 11) screen is shown.

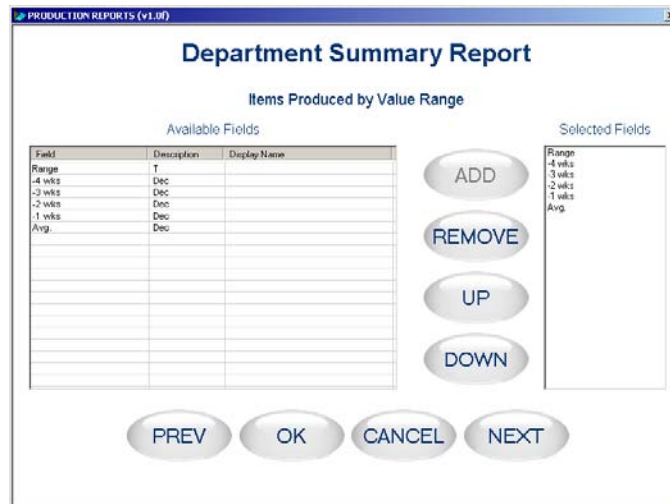

Figure 12: Configuring fields for "Items Produced by Value Range"

NEXT: By pressing this button, the next configuration (Figure 13) screen is shown.

PREV: By pressing this button, the previous configuration (Figure 11) screen is shown.

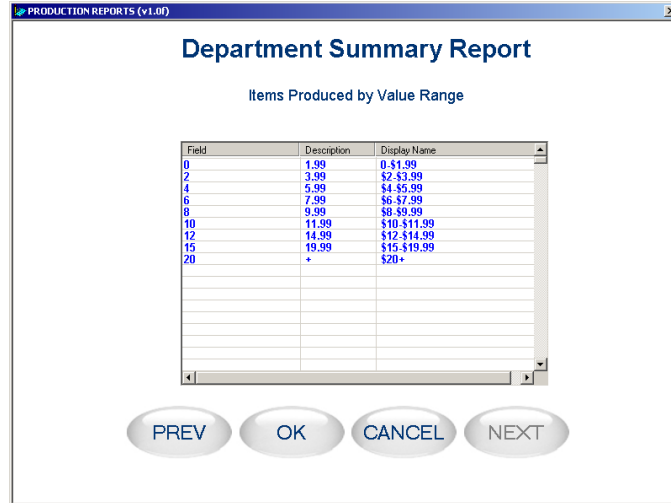

Figure 13: Configuring fields for “Items Produced by Value Range”

NEXT: Not available (disabled) for this configuration Screen.

PREV: By pressing this button, the previous configuration (Figure 12) screen is shown.

If the user wishes to change the default database to another database, the following figure is shown:

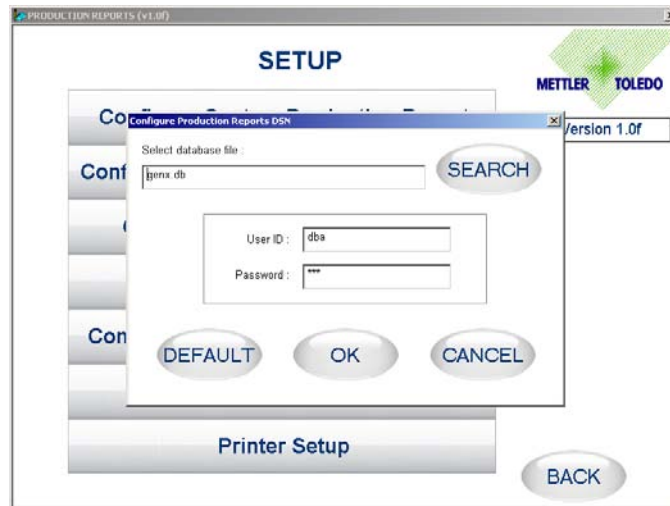

Figure 14: Configuring Database connection.

Select database file: With this option, the user can browse and select a database (either remote and local) for the use of production reports.

User ID & Password: The user has to enter the Connection parameters in these fields.

OK: By pressing this button, the details are saved and used for the running production reports.

CANCEL: By pressing this button, the details if modified, are discarded and not saved.

DEFAULT: By pressing this button, the user changes are discarded and the default database and connection settings are loaded.

Additional Controls

For facilitating the user to operate the touch screen, the following options are provided:

Alpha Keyboard:

The screen shown below is used to enter alphabetic characters into the selected field.

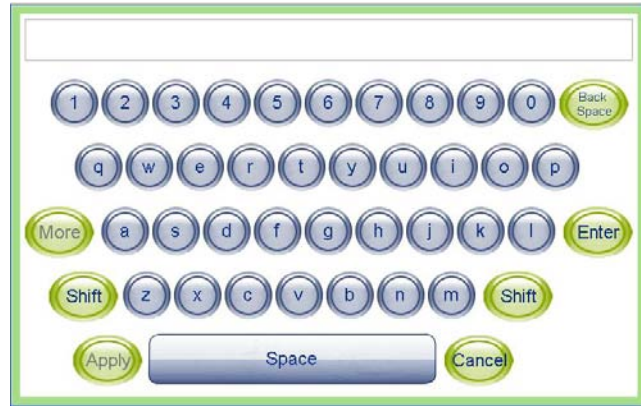

Figure 15: Alpha Keyboard

When the user presses a button, the corresponding character is added to the field. By pressing Enter button, the value entered is selected into the responding field.

When the user presses a button, the corresponding digit is added to the field. By pressing Enter button, the value entered is selected into the responding field.

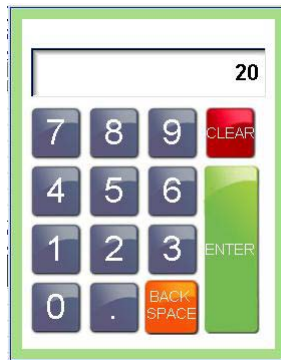

Figure 16: Numeric Keypad



Figure 17: Date Selector

< & > : By pressing these buttons, Previous or Next month is displayed.

<< & >> : By pressing these buttons, Previous or Next year is displayed.

1... 31 : By pressing these buttons, corresponding date is selected.

10

Label Requirements

This chapter includes dimensional requirements, for labels and label rolls, as well as general requirements for label paper, thermal coatings, preprinting inks and adhesives for use in the Model 317 thermal label printer. Use of label materials and designs which meet with these requirements is necessary to ensure operation of the printers in compliance with their respective functional specifications and satisfactory performance of the label in the end use environment. Labels that do not comply with all of the requirements of this document may function with limitations, but would need to be tested by the customer to insure adequate performance in their application.

General Requirements

Label Paper

Price Label	Premium white color, black imaging, with protective coating
DayGlo Label	Red orange fluorescent, black imaging, with protective coating
Weight	72 ± 7 grams/square meter
Thickness	82 ± 14 μ meter (0.0032 inch)
Activation Temperature	Standard: Initial 74°C (165°F); Optimum 83°C (181°F) High Speed: Initial 66°C (151°F); Optimum 77°C (170°F) – for highest speed printing Hot Box: Initial 83°C (181°F); Optimum 91°C (195°F) - for use on food items which are kept warm
Surface Smoothness	The surface of the finished coated paper must be smooth to prevent premature print head failure. Smoothness must be 40 Sheffield units or smoother.
Ion Content	Ions such as sodium (Na) and chlorine (Cl) can cause premature failure of the glass overcoat of a thermal print head. Paper manufactured specifically for thermal printing with low ion content must be used.
Storage Life	18 months minimum when stored at less than 85% relative humidity and less than 35°C (95°F)

Adhesive

Permanent pressure sensitive – Nominal thickness 10 μ meter (0.0004 inch)
Label must adhere to product with a surface temperature of -15° C (5° F) minimum.
Bond strength must remain permanent over a temperature range of 2°C to 35°C (35°F to 95° F)

Release Liner

Description	White semi-bleached supercalendered Kraft paper with silicone release coating.
Basis Weight	68 ± 3 gram/square meter
Thickness	67 ± 7 μ METER (0.0026 INCH)

Total Thickness Label + Adhesive + Liner

159 ± 17 μ METER (0.0056 to 0.0069 inch)

Light Transmission for Gap Sensor Operation

Light transmission at 800 to 900 NM wave length through the liner only must be at least 3 times the transmission through the liner and label together. This means that the transmission optical density of the liner must be at least 0.48 less than the that of the liner and label together.

Light transmission at 800 to 900 NM wave length through the liner and label together must be at least 2% of incident light. This corresponds to an optical density of 1.7.

Also see OPTICAL DENSITY DEFINITION further in this chapter.

Label Stripping

Labels must strip from the liner over a temperature range of 2°C (26°F) at 50% RH to 43°C (110°F) at 85% RH.

Finished Label Roll Requirements

Core and Method of Label Attachment

The label stock must not be permanently attached to the cardboard core. The liner must separate cleanly from the core with 1.0 pound pull tangent to the core as shown in the figure below. No core material, tape, or adhesive is to remain on the label or liner after separation. Material, especially hot melt adhesive, remaining on the label will damage the print head.

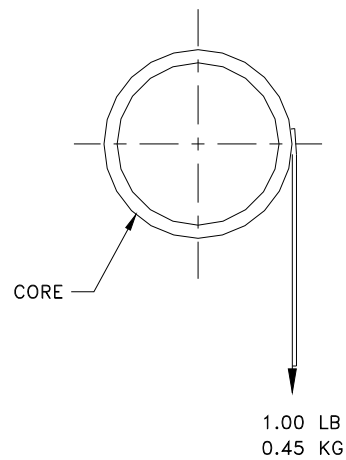

Die Cutting

Die cutting of the labels must not perforate the release liner.

Slitting

The release liner must be slit cleanly and be made free of edge slivers and dust by vacuuming or some equally effective process.

Winding

The labels must be wound face out as shown in the figure below. The finished roll must be made free of paper dust and loose particles by vacuuming or some equally effective process.

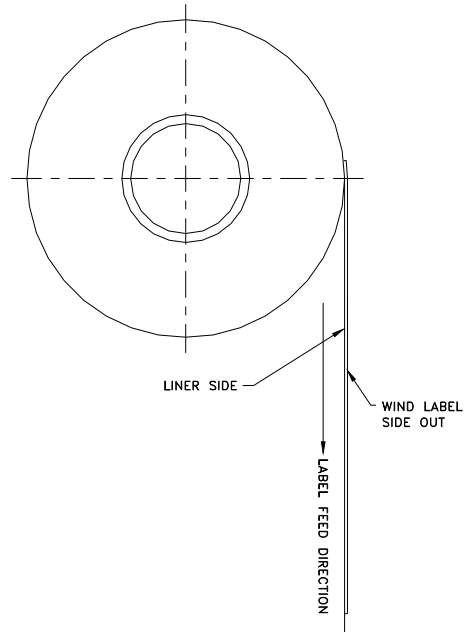

Label Curl

Stripped labels must not curl more than 0.20 inch as specified in the figure below.

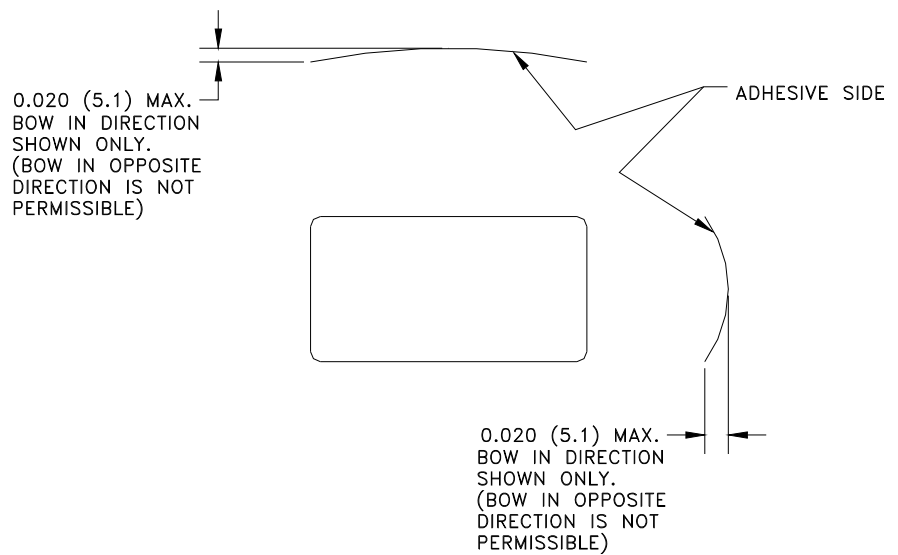

Splicing

Each roll may contain one splice on non-label side of liner using 0.002 inch maximum thickness tape as shown below.

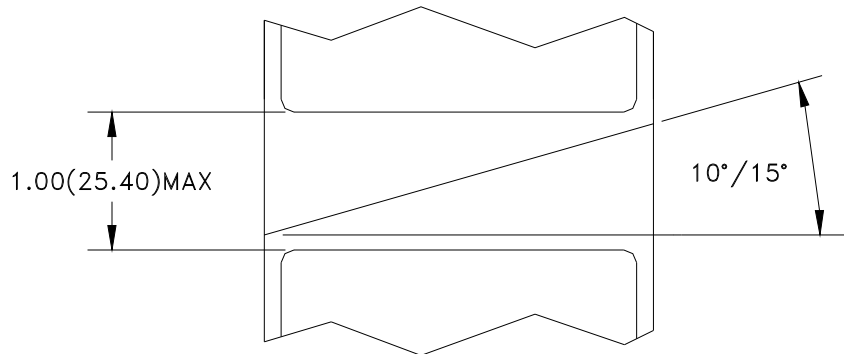

Finished Label and Roll Dimensional Requirements

Core ID	4.00 inch (101.58 MM) Price Label 1.56 INCH (40 MM) DayGlo Label
Core Width	2.69 ± 0.03 (68.3 MM ± 0.8 MM)
Maximum Roll OD	9.5 inch (240MM) for 317
Label and liner width	Standard Price Label 2.625 ± 0.01 inch (66.7 mm) Standard Liner Width (Price Label) 2.72 ± 0.01 inch (69.1 mm) Standard DayGlo Label Width 1.575 Inch (40 mm) Standard Liner Width (DayGlo Label) 1.673 (42.5 mm)
Liner Width Limits	1.575 Inch (40 mm) Minimum; 3.346 (85 mm) Maximum
Label Length	0.97 Inch (24.6 Mm) Minimum; 7.0 Inch (177.8 mm) Maximum. 317 automatic application – 4.2" maximum length.
Standard Gap Width	Standard price label gap = 0.125 ± 0.01 inch (3.18 mm) Standard DayGlo label gap = 0.078 (2mm) at center
Gap Width Limits	0.078 Inch (2 Mm) Minimum; 0.236 Inch (6 mm) Maximum

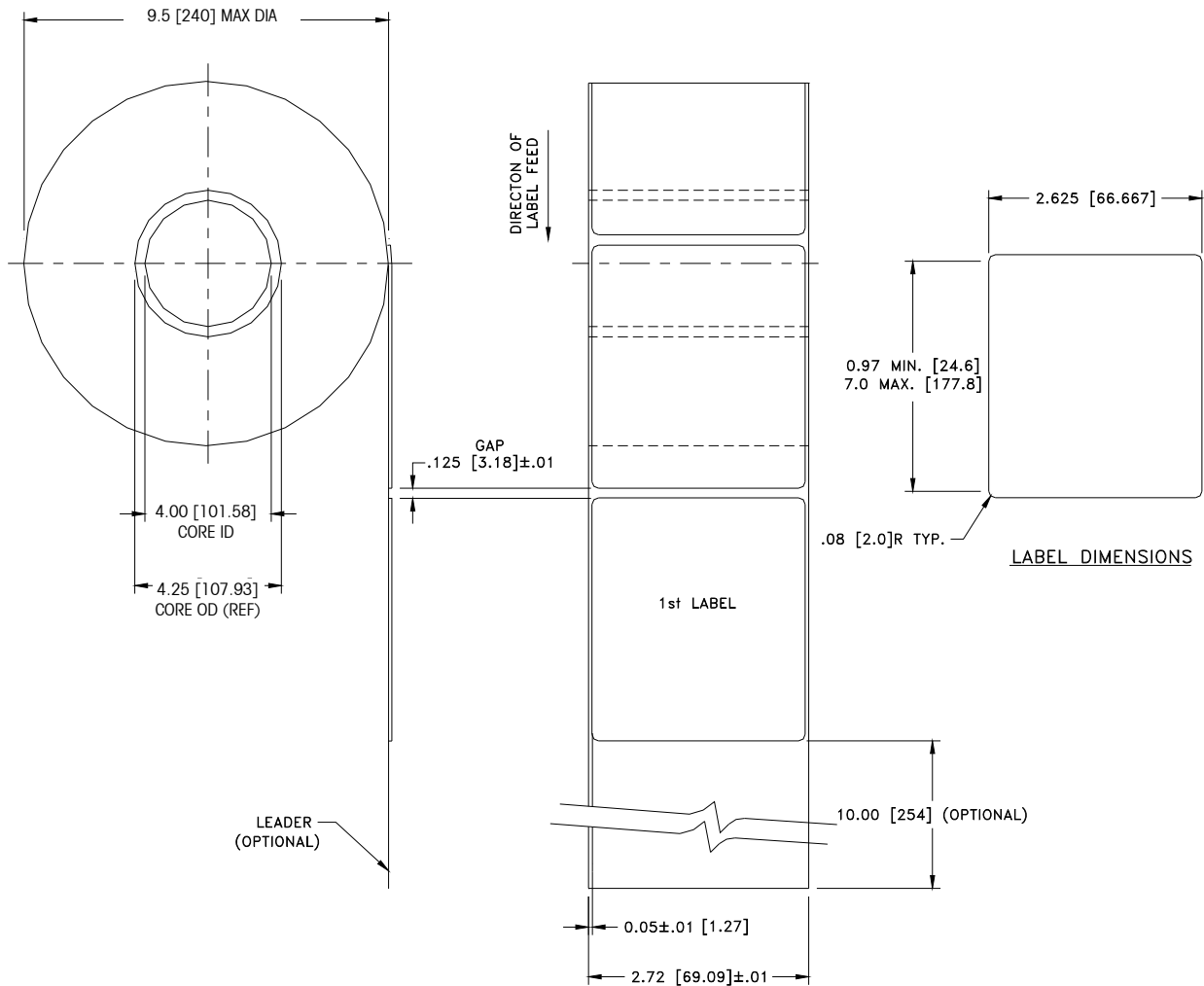

Finished Roll and Label Detail – Price Label

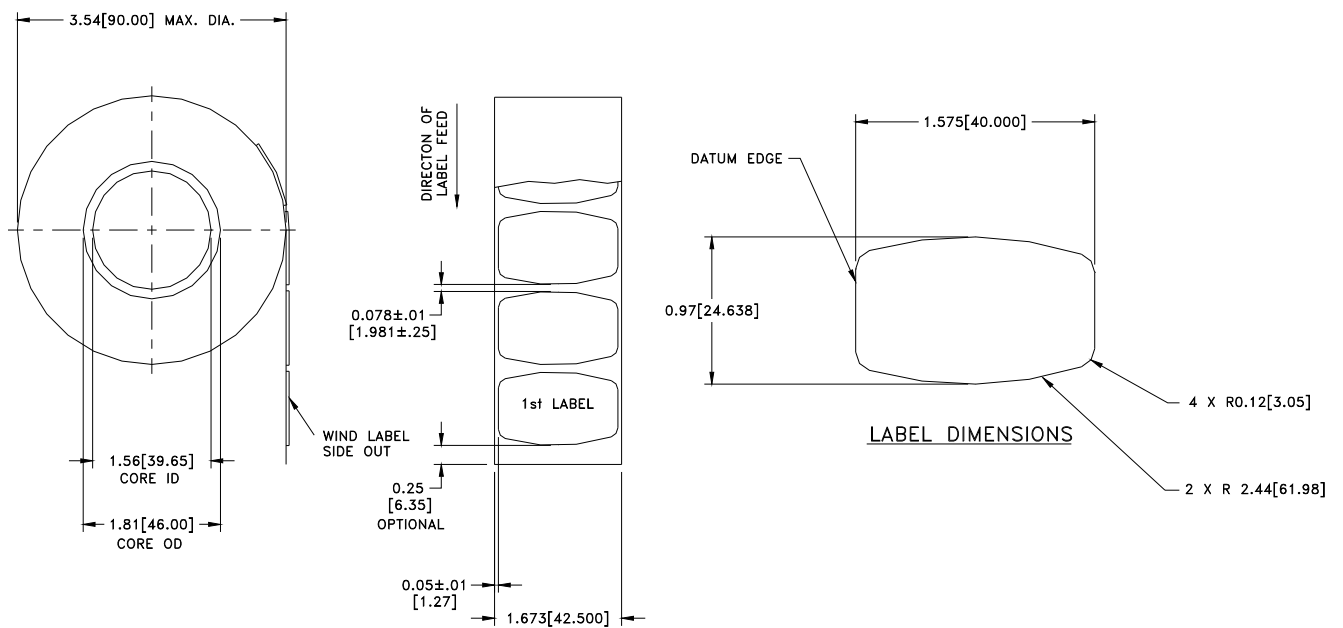

Finished Roll and Label Detail – DayGlo Label

Preprinted Labels

To ensure trouble free operation of the printer gap sensor, and to achieve normal print head life, no pre printing should be placed on the label in the gap sensor path or in areas which will be printed by the scale printer. However, since preprinting is commonly used by many customers the following guidelines must be followed.

1. Inks used for preprinting must be specially formulated for use in thermal printers. If proper inks are not used they can adhere to the print head. This ink build up on the print head will interfere with heat transfer from the print head to the paper and cause printing elements to burn out. Another problem with inks not formulated for thermal printing is that they can contain chemicals which will cause the glass overcoat to chip off of the print head, causing failure to print in the chipped areas.
2. If black ink is used in preprinting in the gap sensor path shown below, a dense black stripe will have to be printed on the back of the liner, as shown below, to prevent the gap sensor from being affected by the black preprinting. (Colors other than black might also be a problem and should be tested by the customer) The black stripe on the liner must have gaps which correspond to the label gaps. The black stripe on the liner must have a minimum transmission optical density of 2.3 and must be uniform. In addition, the gap sensor circuit will need to be adjusted for operation with the black stripe as explained in the product service manual. This adjustment will need to be checked any time label paper is changed, for example when labels are procured from a new supplier.

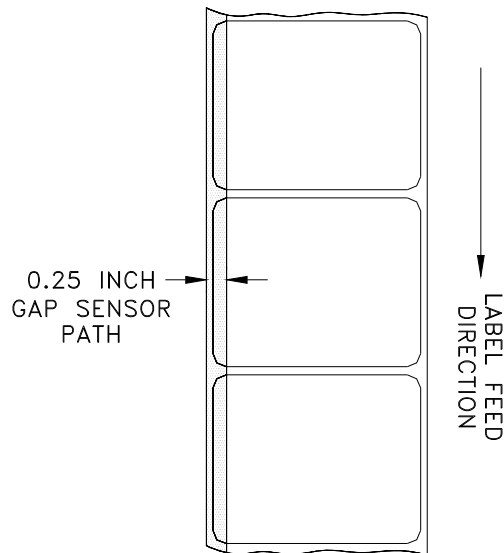

Gap Sensor Path

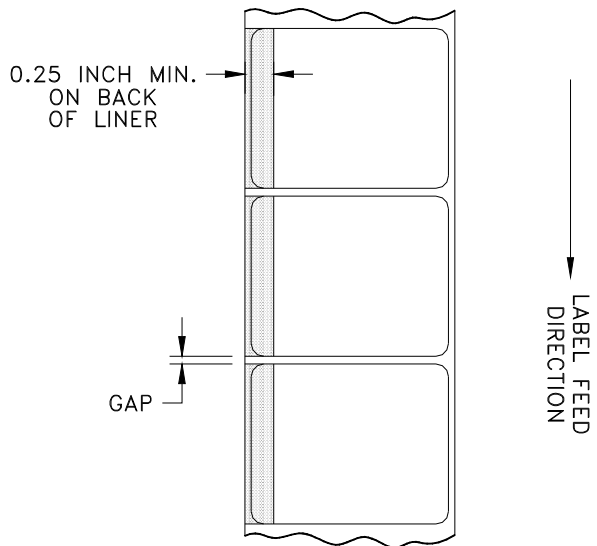

Black Stripe

3. If an optical density of at least 2.3 cannot be achieved in the black stripe on the back of the liner, the liner width should be increased as shown in Figure 9 so that the preprinted label is not in the gap sensor path.

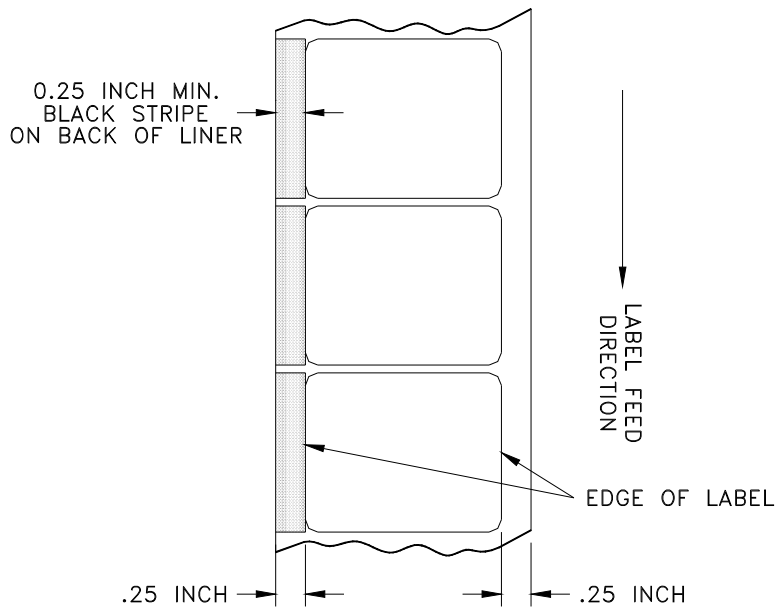

Increased Liner Width

Special Shaped Labels

Labels with shapes other than rectangular will cause gap detection errors if the gap dimension in the gap sensor path is outside the limits given in this document, or if the edge of the label shape crosses into and out of the sensor path as shown below. For these cases the black stripe will have to be printed on the back of the liner as shown above. Tests will be needed to determine if the stripe as shown earlier will be adequate or if additional liner width will be required (see above).

The safe approach is to use the configuration shown increasing the width on all odd shaped labels.

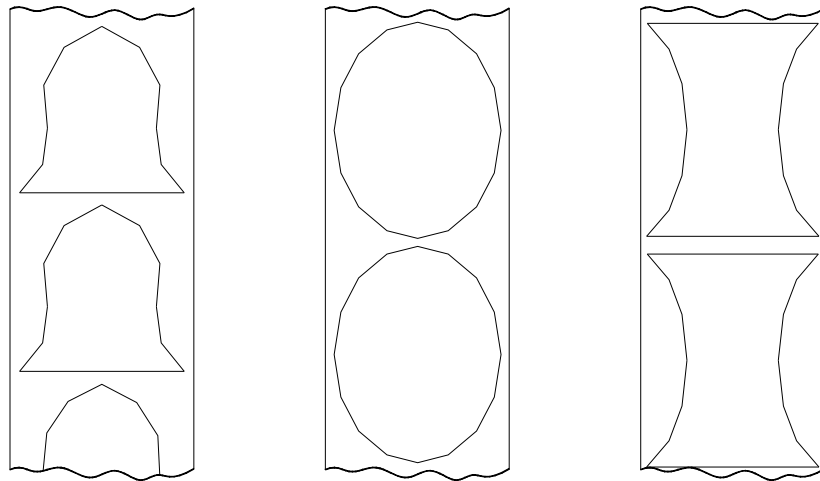

**Examples of Odd Shaped Labels which will cause
GAP Sensor problems and will need the Black Stripe**

Definition of Transmission Optical Density

Transmission optical density is defined as:

- Optical Density = $\log_{10} (\text{incident light} / \text{transmitted light}) = \log_{10} (100 / \% \text{ light transmission})$
- Transmission optical density can be measured with a transmission densitometer that meets ANSI standards. Examples are the Macbeth model TD903 and TD932.
- Optical density for 100% light transmission = $\log_{10} (100/100) = \log_{10} (1) = 0$
- Optical density for 0.1% light transmission = $\log_{10} (100/0.1) = \log_{10} (1000) = 3$

Label and Liner Optical Density

If liner paper transmits 2% of the light which is incident on it, the optical density is

$$\log_{10} (100/2) = 1.7$$

If the light transmitted through the liner is 3 times the light transmitted through the liner and label, the relative optical densities are:

$$\begin{aligned} \text{Optical Density of Liner + Label} &= \log_{10} (100 / X) \\ \text{Optical Density of Liner Only} &= \log_{10} (100 / 3X) \\ &= \log_{10} (0.3333X) \\ &= \log_{10} 0.3333 + \log_{10} (X) \\ &= \log_{10} (X) - 0.48 \end{aligned}$$

Therefore, if the liner must transmit 3 times the light that the liner and label transmits, the transmission optical density of the liner must be 0.48 less than the transmission optical density of the liner and label.

Black Stripe Optical Density

If only 0.5 % of incident light is transmitted through the black stripe, the optical density is:

$$\log_{10} (100 / 0.5) = \log_{10} (200) = 2.3$$

The purpose of specifying a transmission optical density of at least 2.3 for the printed black stripe on the back of the label is to minimize any variation in light transmission as a result of black pre-printing on the front of the label. This variation due to black preprinting can cause the gap sensor to give gap detection errors.



METTLER TOLEDO Service



Quality Management System certification.

Development, production, and auditing in accordance with ISO9001. Environmental management system in accordance with ISO14001.

Worldwide service. Our dense service network, among the best in the world, ensures the maximum availability and lifespan of your product.

Conformité Européene - This label is your guarantee that our products conform to the latest guidelines.



On the Internet. You can find important information about our products and services, as well as our company, quickly and easily at <http://www.mt.com/support>



METTLER TOLEDO
1900 Polaris Parkway
Columbus, Ohio 43240
www.mt.com

METTLER TOLEDO® is a registered trademark of Mettler-Toledo, LLC
©2012 Mettler-Toledo, LLC
Printed in USA

