

# IND570

## Weighing Terminal



METTLER TOLEDO

# IND570 Weighing Terminal

## METTLER TOLEDO Service

### Essential Services for Dependable Performance of Your IND570 Weighing Terminal

Congratulations on choosing the quality and precision of METTLER TOLEDO. Proper use of your new equipment according to this Manual and regular calibration and maintenance by our factory-trained service team ensures dependable and accurate operation, protecting your investment. Contact us about a service agreement tailored to your needs and budget. Further information is available at [www.mt.com/service](http://www.mt.com/service).

There are several important ways to ensure you maximize the performance of your investment:

1. **Register your product:** We invite you to register your product at [www.mt.com/productregistration](http://www.mt.com/productregistration) so we can contact you about enhancements, updates and important notifications concerning your product.
2. **Contact METTLER TOLEDO for service:** The value of a measurement is proportional to its accuracy – an out of specification scale can diminish quality, reduce profits and increase liability. Timely service from METTLER TOLEDO will ensure accuracy and optimize uptime and equipment life.
  - a. **Installation, Configuration, Integration and Training:** Our service representatives are factory-trained, weighing equipment experts. We make certain that your weighing equipment is ready for production in a cost effective and timely fashion and that personnel are trained for success.
  - b. **Initial Calibration Documentation:** The installation environment and application requirements are unique for every industrial scale so performance must be tested and certified. Our calibration services and certificates document accuracy to ensure production quality and provide a quality system record of performance.
  - c. **Periodic Calibration Maintenance:** A Calibration Service Agreement provides on-going confidence in your weighing process and documentation of compliance with requirements. We offer a variety of service plans that are scheduled to meet your needs and designed to fit your budget.
  - d. **GWP®:** A risk-based approach for managing weighing equipment allows for control and improvement of the entire measuring process, which ensures reproducible product quality and minimizes process costs. GWP, the science-based standard for efficient **life-cycle management of weighing equipment**, gives clear answers about how to specify, calibrate and ensure accuracy of weighing equipment, independent of make or brand. GWP covers every relevant step in the equipment's life cycle.
  - e. **InTouch<sup>SM</sup> Remote Services:** Confidently and securely improve the performance and uptime of your weighing systems, with InTouch Remote Service, only available from METTLER TOLEDO. Working within your existing IT security policies, IND570 with embedded InTouch connectivity actively monitors system performance. Proactive alerts to remote service technicians allow a real-time response to performance issues, increasing uptime, overall asset utilization and reduction of unforeseen expenses.

© METTLER TOLEDO 2019

No part of this manual may be reproduced or transmitted in any form or by any means, electronic or mechanical, including photocopying and recording, for any purpose without the express written permission of METTLER TOLEDO.

U.S. Government Restricted Rights: This documentation is furnished with Restricted Rights.

Copyright 2019 METTLER TOLEDO. This documentation contains proprietary information of METTLER TOLEDO. It may not be copied in whole or in part without the express written consent of METTLER TOLEDO.

METTLER TOLEDO reserves the right to make refinements or changes to the product or manual without notice.

### **COPYRIGHT**

METTLER TOLEDO® is a registered trademark of Mettler-Toledo, LLC. All other brand or product names are trademarks or registered trademarks of their respective companies.

### **METTLER TOLEDO RESERVES THE RIGHT TO MAKE REFINEMENTS OR CHANGES WITHOUT NOTICE.**

### **FCC Notice**

This device complies with Part 15 of the FCC Rules and the Radio Interference Requirements of the Canadian Department of Communications. Operation is subject to the following conditions: (1) this device may not cause harmful interference, and (2) this device must accept any interference received, including interference that may cause undesired operation.

This equipment has been tested and found to comply with the limits for a Class A digital device, pursuant to Part 15 of FCC Rules. These limits are designed to provide reasonable protection against harmful interference when the equipment is operated in a commercial environment. This equipment generates, uses, and can radiate radio frequency energy and, if not installed and used in accordance with the instruction manual, may cause harmful interference to radio communications. Operation of this equipment in a residential area is likely to cause harmful interference in which case the user will be required to correct the interference at his or her expense.













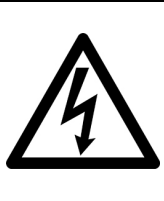

- Declaration of Conformity may be found at <http://glo.mt.com/us/en/home/search/compliance.html/compliance/>.

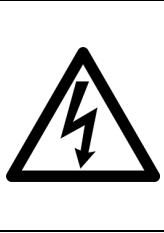
### **Statement regarding harmful substances**

We do not make direct use of harmful materials such as asbestos, radioactive substances or arsenic compounds. However, we purchase components from third party suppliers, which may contain some of these substances in very small quantities.

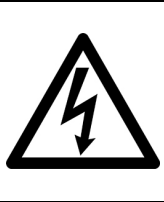
## Warnings and Cautions

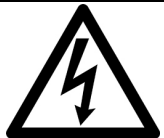













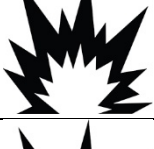
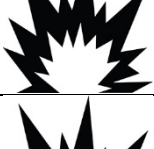

- READ this manual BEFORE operating or servicing this equipment. FOLLOW these instructions carefully.
- SAVE this manual for future reference.



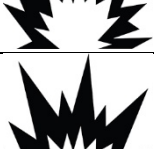

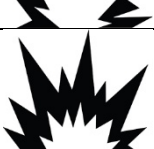

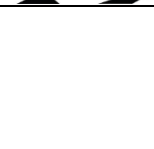

	<p style="text-align: center;"> <b>WARNING</b></p> <p>FOR CONTINUED PROTECTION AGAINST SHOCK HAZARD CONNECT THE TERMINAL TO PROPERLY GROUNDED OUTLET ONLY. DO NOT REMOVE THE GROUND PRONG.</p>
	<p style="text-align: center;"> <b>WARNING</b></p> <p>WHEN THIS EQUIPMENT IS INCLUDED AS A COMPONENT PART OF A SYSTEM, THE RESULTING DESIGN MUST BE REVIEWED BY QUALIFIED PERSONNEL WHO ARE FAMILIAR WITH THE CONSTRUCTION AND OPERATION OF ALL COMPONENTS IN THE SYSTEM AND THE POTENTIAL HAZARDS INVOLVED. FAILURE TO OBSERVE THIS PRECAUTION COULD RESULT IN BODILY HARM AND/OR PROPERTY DAMAGE.</p>
	<p style="text-align: center;"> <b>WARNING</b></p> <p>NOT ALL VERSIONS OF THE IND570 ARE APPROVED FOR USE IN HAZARDOUS (EXPLOSIVE) AREAS. REFER TO THE PRODUCT DATA LABEL TO DETERMINE WHETHER THE TERMINAL IS APPROVED FOR USE IN AREAS CLASSED AS HAZARDOUS DUE TO COMBUSTIBLE OR EXPLOSIVE ATMOSPHERE. TERMINALS THAT ARE NOT SO LABELED BY THE FACTORY FOR DIVISION 2 OR EUROPEAN CATEGORY 3 MUST NOT BE INSTALLED IN DIVISION 2 OR ZONE 2/22 ENVIRONMENTS.</p>
	<p style="text-align: center;"> <b>WARNING</b></p> <p>ONLY THE COMPONENTS SPECIFIED ON THE IND570 DOCUMENTATION CAN BE USED IN THIS TERMINAL. ALL EQUIPMENT MUST BE INSTALLED IN ACCORDANCE WITH THE INSTALLATION INSTRUCTIONS DETAILED IN THE INSTALLATION MANUAL. INCORRECT OR SUBSTITUTE COMPONENTS AND/OR DEVIATION FROM THESE INSTRUCTIONS CAN IMPAIR THE SAFETY OF THE TERMINAL AND COULD RESULT IN BODILY HARM AND/OR PROPERTY DAMAGE.</p>
	<p style="text-align: center;"> <b>WARNING</b></p> <p>ONLY PERMIT QUALIFIED PERSONNEL TO SERVICE THE TERMINAL. EXERCISE CARE WHEN MAKING CHECKS, TESTS AND ADJUSTMENTS THAT MUST BE MADE WITH POWER ON. FAILING TO OBSERVE THESE PRECAUTIONS CAN RESULT IN BODILY HARM AND/OR PROPERTY DAMAGE.</p>
	<p style="text-align: center;"> <b>CAUTION</b></p> <p>BEFORE CONNECTING/DISCONNECTING ANY INTERNAL ELECTRONIC COMPONENTS OR INTERCONNECTING WIRING BETWEEN ELECTRONIC EQUIPMENT ALWAYS REMOVE POWER AND WAIT AT LEAST THIRTY (30) SECONDS BEFORE ANY CONNECTIONS OR DISCONNECTIONS ARE MADE. FAILURE TO OBSERVE THESE PRECAUTIONS COULD RESULT IN DAMAGE TO OR DESTRUCTION OF THE EQUIPMENT AND/OR BODILY HARM.</p>
	<p style="text-align: center;"> <b>CAUTION</b></p> <p>RISK OF EXPLOSION IF BATTERY IS REPLACED WITH AN INCORRECT TYPE. DISPOSE OF USED BATTERIES ACCORDING TO THE INSTRUCTIONS.</p>
<b><i>NOTICE</i></b>	
<p>THE HARSH TERMINAL MUST BE INSTALLED NEAR AN ELECTRICAL OUTLET (WITHIN THE LENGTH OF THE INTEGRAL LINE CORD) AND THE OUTLET MUST BE EASILY ACCESSIBLE.</p>	









	<b>NOTICE</b>
	OBSERVE PRECAUTIONS FOR HANDLING ELECTROSTATIC SENSITIVE DEVICES.

## Additional Warnings and Cautions for Version IND570xx

	 <b>WARNING</b>
	KEEP THE TERMINAL AWAY FROM PROCESSES THAT GENERATE HIGH CHARGING POTENTIAL SUCH AS ELECTROSTATIC COATING, RAPID TRANSFER OF NON-CONDUCTIVE MATERIALS, RAPID AIR JETS, AND HIGH PRESSURE AEROSOLS.
	 <b>WARNING</b>
	DO NOT INSTALL, DISCONNECT OR PERFORM ANY SERVICE ON THIS EQUIPMENT BEFORE POWER HAS BEEN SWITCHED OFF AND THE AREA HAS BEEN SECURED AS NON-HAZARDOUS BY PERSONNEL AUTHORIZED TO DO SO BY THE RESPONSIBLE PERSON ON-SITE.
	 <b>WARNING</b>
	ONLY Ex APPROVED PRODUCTS WITH APPROPRIATE Ex PARAMETERS MAY BE CONNECTED TO METTLER TOLEDO Ex APPROVED TERMINALS.
	 <b>WARNING</b>
	AVOID ELECTROSTATIC CHARGING DURING OPERATION AND MAINTENANCE.
	 <b>WARNING</b>
	DO NOT USE DRY CLOTH TO CLEAN THE WEIGHING TERMINAL. ALWAYS USE A DAMP CLOTH TO CLEAN THE TERMINAL GENTLY.
	 <b>WARNING</b>
	USE THE WEIGHING TERMINAL ONLY WHEN ELECTROSTATIC PROCESSES LEADING TO PROPAGATION BRUSH DISCHARGE IS IMPOSSIBLE.
	 <b>WARNING</b>
	OPERATION IS ONLY PERMITTED WHEN OPERATIONAL AND PROCESS-RELATED ELECTROSTATIC CHARGES ARE NOT PRESENT.
	 <b>WARNING</b>
	WEAR SUITABLE CLOTHING. AVOID NYLON, POLYESTER OR OTHER SYNTHETIC MATERIALS THAT GENERATE AND HOLD CHARGE. USE CONDUCTIVE FOOTWEAR AND FLOORING.
	 <b>WARNING</b>
	AVOID PLASTIC COVERS OVER THE TERMINAL.

	<p style="text-align: center;"><b>⚠ WARNING</b></p> <p>THE USB INTERFACE IS NOT CERTIFIED FOR USE IN DIVISION 2 OR ZONE 2/22 HAZARDOUS AREAS. USE ONLY IN SAFE AREA.</p>
	<p style="text-align: center;"><b>⚠ WARNING</b></p> <p>EXTERNAL USB ADAPTOR PART NO. 30139559 IS NOT CERTIFIED FOR USE WITH IND570xx.</p>
	<p style="text-align: center;"><b>⚠ WARNING</b></p> <p>METTLER TOLEDO ASSUMES NO RESPONSIBILITY FOR CORRECT INSTALLATION OF THIS EQUIPMENT WITHIN A DIVISION 2 OR ZONE 2/22 AREA. THE INSTALLER MUST BE FAMILIAR WITH ALL DIVISION 2 OR ZONE 2/22 WIRING AND INSTALLATION REQUIREMENTS.</p>
	<p style="text-align: center;"><b>⚠ WARNING</b></p> <p>THE IND570xx TERMINAL IS NOT INTRINSICALLY SAFE LEVEL "a" OR "b"! DO NOT USE WITHIN AREAS CLASSIFIED AS HAZARDOUS DIVISION 1 OR ZONE 0/1/20/21 BECAUSE OF COMBUSTIBLE OR EXPLOSIVE ATMOSPHERES. FAILURE TO COMPLY WITH THIS WARNING COULD RESULT IN BODILY HARM AND/OR PROPERTY DAMAGE.</p>
	<p style="text-align: center;"><b>⚠ WARNING</b></p> <p>THE IND570xx TERMINAL HAS A TEMPERATURE RATING OF T5 (100° C) FOR GAS AND A MAXIMUM SURFACE TEMPERATURE RATING OF 85° C FOR DUST. IT MUST NOT BE USED IN AREAS WHERE THE AUTO IGNITION TEMPERATURE OF THE HAZARDOUS MATERIAL IS BELOW THIS RATING.</p>
	<p style="text-align: center;"><b>⚠ WARNING</b></p> <p>VERSIONS OF THE IND570 TERMINAL THAT ARE NOT FACTORY-LABELED AS DIVISION 2 OR ZONE 2/22 APPROVED MUST NOT BE INSTALLED INTO A DIVISION 2 OR ZONE 2/22 ENVIRONMENT.</p>
	<p style="text-align: center;"><b>⚠ WARNING</b></p> <p>IN ORDER TO INSTALL THE IND570xx TERMINAL UTILIZING THE U.S./CANADIAN APPROVAL, METTLER TOLEDO CONTROL DRAWING 30116036 MUST BE FOLLOWED WITHOUT EXCEPTION. IN ORDER TO INSTALL THE CATEGORY 3 MARKED IND570xx TERMINAL UTILIZING THE EUROPEAN APPROVAL CERTIFICATE FM14ATEX0047X AND ALL LOCAL REGULATIONS MUST BE FOLLOWED WITHOUT EXCEPTION. IN ORDER TO INSTALL THE IND570xx TERMINAL UTILIZING THE IECEx APPROVAL, THE IECEx APPROVAL CERTIFICATE IECEx FMG 14.0022X AND ALL LOCAL REGULATIONS MUST BE FOLLOWED WITHOUT EXCEPTION. FAILURE TO DO SO COULD RESULT IN BODILY HARM AND/OR PROPERTY DAMAGE.</p>
	<p style="text-align: center;"><b>⚠ WARNING</b></p> <p>THE IND570xx TERMINAL MUST BE INSTALLED AND MAINTAINED PER THE SPECIAL CONDITIONS LISTED IN CHAPTER 2 OF THE VERSION IND570xx INSTALLATION MANUAL WITHOUT EXCEPTION. FAILURE TO DO SO COULD RESULT IN BODILY HARM AND/OR PROPERTY DAMAGE.</p>
	<p style="text-align: center;"><b>⚠ WARNING</b></p> <p>IF THE KEYBOARD, DISPLAY LENS OR ENCLOSURE IS DAMAGED ON A DIVISION 2 OR ZONE 2/22 APPROVED IND570xx TERMINAL THAT IS USED IN A DIVISION 2 OR ZONE 2/22 AREA, THE DEFECTIVE COMPONENT MUST BE REPLACED IMMEDIATELY. REMOVE POWER IMMEDIATELY AND DO NOT REAPPLY POWER UNTIL THE DISPLAY LENS, KEYBOARD OR ENCLOSURE HAS BEEN REPLACED BY QUALIFIED SERVICE PERSONNEL. FAILURE TO DO SO COULD RESULT IN BODILY HARM AND/OR PROPERTY DAMAGE.</p>

	<p style="text-align: center;"> <b>WARNING</b></p> <p><b>THE INTERNAL DISCRETE I/O RELAY OPTION #30113540, OR #30113542 MUST NOT BE USED IN AN IND570xx TERMINAL. FAILURE TO COMPLY WITH THIS WARNING COULD RESULT IN BODILY HARM AND/OR PROPERTY DAMAGE.</b></p>
	<p style="text-align: center;"> <b>WARNING</b></p> <p><b>THE OPTIONAL WiFi MODULE (3049 AND 3049) MUST NOT BE USED IN AN IND570xx TERMINAL. FAILURE TO COMPLY WITH THIS WARNING COULD RESULT IN BODILY HARM AND/OR PROPERTY DAMAGE.</b></p>
	<p style="text-align: center;"> <b>WARNING</b></p> <p><b>USE ONLY METTLER TOLEDO PART NUMBER 30237707 BATTERY.</b></p>

## Disposal of Electrical and Electronic Equipment

In conformance with the European Directive 2002/96/EC on Waste Electrical and Electronic Equipment (WEEE) this device may not be disposed of in domestic waste. This also applies to countries outside the EU, per their specific requirements.



Please dispose of this product in accordance with local regulations at the collecting point specified for electrical and electronic equipment.

If you have any questions, please contact the responsible authority or the distributor from which you purchased this device.

Should this device be passed on to other parties (for private or professional use), the content of this regulation must also be related.

Thank you for your contribution to environmental protection.

# Contents

<b>1</b>	<b>Introduction</b> .....	<b>1-1</b>
1.1.	IND570 Overview .....	1-2
1.2.	Specifications .....	1-4
1.3.	Environmental Protection .....	1-8
1.4.	Inspection and Contents Checklist .....	1-8
1.5.	Model Identification .....	1-9
1.6.	Physical Dimensions.....	1-11
1.7.	Main PCB .....	1-14
1.8.	Scale Types.....	1-15
1.9.	Options.....	1-17
1.10.	Display and Keyboard .....	1-23
<b>2</b>	<b>Operation</b> .....	<b>2-1</b>
2.1.	Overview.....	2-1
2.2.	User Security .....	2-1
2.3.	Terminal Operation.....	2-4
2.4.	Understanding the HMI (Human Machine Interface).....	2-5
2.5.	Data Entry .....	2-11
2.6.	Home Screen.....	2-16
2.7.	Basic Functionality .....	2-16
2.8.	USB Host .....	2-47
2.9.	WiFi Operation.....	2-51
2.10.	Error Management, Diagnostic Information and Service Options.....	2-52
<b>3</b>	<b>Configuration</b> .....	<b>3-1</b>
3.1.	Entering Setup Mode.....	3-1
3.2.	Exiting Setup Mode .....	3-2
3.3.	Setup Menu Tree .....	3-2
3.4.	Overview of Configuration .....	3-5
3.5.	Scale .....	3-7
3.6.	Application .....	3-68
3.7.	Terminal .....	3-82
3.8.	Communication .....	3-97
3.9.	Maintenance .....	3-126

<b>4</b>	<b>Applications .....</b>	<b>4-1</b>
4.1.	Hands-off Operation: Automatic Tare and Automatic Print.....	4-1
4.2.	Print to USB.....	4-4
4.3.	Comparators: Configuration and Operation .....	4-6
4.4.	ID Prompting.....	4-9
4.5.	Information Recall .....	4-14
4.6.	Remote Terminal.....	4-19
4.7.	Simple Filling .....	4-24
<b>5</b>	<b>Service and Maintenance .....</b>	<b>5-1</b>
5.1.	Cleaning and General Maintenance .....	5-1
5.2.	Service .....	5-2
5.3.	Screen Saver .....	5-3
5.4.	System Backup and Restore .....	5-3
5.5.	Backup and Restore Using InSite™ SL.....	5-7
5.6.	Upgrading Firmware .....	5-7
5.7.	Restore Scale Data .....	5-9
5.8.	Leveling Guidance .....	5-11
5.9.	Problem Diagnosis and Troubleshooting.....	5-12
5.10.	Web Server – Analog, IDNet and SICSpro .....	5-28
5.11.	Web Server – POWERCELL.....	5-38
5.12.	Master Reset .....	5-47
5.13.	InTouch <sup>SM</sup> .....	5-48
5.14.	Proactive Alarming and Alerting .....	5-54
<b>6</b>	<b>Parts and Accessories .....</b>	<b>6-1</b>
6.1.	Harsh Enclosure .....	6-1
6.2.	Panel-Mount Enclosure.....	6-4
6.3.	Miscellaneous Parts .....	6-5
6.4.	Options and Accessories.....	6-6
6.5.	Software Applications .....	6-14
<b>A</b>	<b>Default Settings.....</b>	<b>A-1</b>
A.1.	Setup Defaults and Security Access .....	A-1
A.2.	Softkeys Security Access .....	A-15
A.3.	Default Templates .....	A-20
<b>B</b>	<b>Table and Log File Structure .....</b>	<b>B-1</b>
B.1.	Alibi Memory .....	B-1



B.2.	Memory Tables .....	B-3
B.3.	Log Files .....	B-8
B.4.	Resetting Log Files .....	B-15
<b>C</b>	<b>Communications</b> .....	<b>C-1</b>
C.1.	Available Communication Interfaces .....	C-1
C.2.	Logical (User Definable) Connections .....	C-6
C.3.	Inputs .....	C-7
C.4.	Output Templates .....	C-9
C.5.	Communication Outputs .....	C-11
C.6.	Continuous Output Mode .....	C-14
C.7.	Standard Interface Command Set (SICS) Protocol .....	C-20
C.8.	Remote Discrete I/O (ARM100) .....	C-33
C.9.	Report Printing .....	C-34
C.10.	Shared Data Access .....	C-41
C.11.	File Transfer .....	C-52
C.12.	Remote Display .....	C-57
<b>D</b>	<b>GEO Codes</b> .....	<b>D-1</b>
D.1.	Original Site Calibration .....	D-1
D.2.	New Site GEO Code Adjustment .....	D-1

# 1 Introduction

	<b>! DIV 2 AND ZONE 2/22 INSTALLATION</b>
	<b>IF YOU WISH TO INSTALL AN IND570xx IN A DIVISION 2 OR ZONE 2/22 AREA, REFER TO THE DIVISION 2 AND ZONE 2/22 INSTALLATION INSTRUCTIONS AVAILABLE FOR DOWNLOAD AT <a href="http://WWW.MT.COM/IND570">WWW.MT.COM/IND570</a>. FAILURE TO COMPLY WITH THE INSTRUCTIONS PROVIDED THERE COULD RESULT IN BODILY HARM AND/OR PROPERTY DAMAGE.</b>

This chapter covers

- IND570 Overview
- IND570 Terminal Versions
- Specifications
- Safe Disposal Requirement
- Model Identification
- Physical Dimensions
- Interfaces and Options
- Display and Keyboard

The IND570 represents the latest in METTLER TOLEDO technology and is one of the most versatile weighing terminals available today. Choose from conventional strain gauge or high-precision electromagnetic force restoration weighing technologies. Specify direct PLC or PC communication interfaces or digital I/O control. Combine these selections with the option of panel or desk/wall/column-mounting, and the IND570 is the perfect match for nearly any industrial weighing application, including:

- Vehicle Weighing
- Silo and Hopper Weighing
- Transaction Weighing
- Process Weighing
- Basic Weighing
- Filling and Blending
- Dosing
- Tank Weighing
- Over/Under Checkweighing

Enhance measurement or control applications with an ultra-fast A/D conversion rate of 366 Hz, patented TraxDSP™ digital filtering technology, and an I/O bus update rate of 50 Hz with conventional strain gauge load cells. The IND570 delivers precision measurement data from milligrams to tons in a single cost effective package that easily integrates into existing systems.

The versatile IND570 excels in controlling vehicle and large vessel weighing, and simple filling and dosing applications delivering best-in-class performance for fast, precise, accurate results in manual, semi-automatic, or fully automatic operations. Utilize the control capabilities of the IND570 to effectively manage project costs. Control up to 20 digital outputs through the IND570 without use of a PLC.

For more advanced filling, the Fill-570 application enhances the IND570 terminal with a set of capabilities designed to make repetitive filling and dispensing processes straightforward and reliable. Without complex and costly programming, quickly configure the Fill-570 advanced filling software, creating custom filling and dosing sequences along with blending applications for up to 6 materials that cue operators and track process data, ultimately supporting efficiency, quality and safety.

Whether communicating weight data to a PLC or providing an easier way to perform terminal configuration, the IND570 is easily customized to meet process requirements, adding costs only where needed. In addition to a standard USB host and multi-function serial port, the IND570 has three option slots that support PLC interfaces, network communication ports, and an array of digital I/O choices.

## 1.1. IND570 Overview

### 1.1.1. Versions

The IND570 is available in the following versions:

#### 1.1.1.1. AC Powered Models (85-264VAC)

- Harsh enclosure with conventional analog load cell, high-precision IDNet or SICSpro platforms, or POWERCELL load cell connection
- Panel-mount enclosure with conventional analog load cell, high-precision IDNet or SICSpro platforms, or POWERCELL load cell connection

#### 1.1.1.2. 24VDC Powered Models

- Panel-mount enclosure with either conventional analog load cell, high-precision IDNet or SICSpro load cell connection

### 1.1.2. Standard IND570 Features

- Basic weighing terminal for use in safe areas or Division 2 and Zone 2/22 areas (IND570xx versions) Panel-mount or harsh environment desk/wall/column-mount enclosures
- Panel-mount or harsh environment desk/wall/column-mount enclosures
- Connection for one scale:
  - Single analog load cell scale base
    - A network of up to 12 350-ohm load cells (8 for IND570xx)
  - Single high-precision IDNet or SICSpro base
  - A network of up to 14 POWERCELLs (6 for IND570xx) or a single PowerDeck platform
- Multiple range and multiple interval weighing
- 256 x 128 dot-matrix graphic display with 25 mm-high weight display
- Display, receipt and transmission of information in multiple languages
- USB host port for connection of external keyboard, USB memory device or barcode scanner. The USB port is also used to connect the WiFi option

	 <b>WARNING</b>
	<b>THE USB INTERFACE IS NOT CERTIFIED FOR USE IN DIVISION 2 OR ZONE 2/22 HAZARDOUS AREAS. USE ONLY IN SAFE AREA.</b>

- One serial port (isolated in IND570 POWERCELL) for asynchronous, bidirectional communication and print output via RS-232, RS-422 or RS-485
- Second isolated serial port for RS-232 communication (IND570 POWERCELL only)
- Operation as a Remote Display for another METTLER TOLEDO terminal
- Real-time clock with battery backup

- Basic weighing functions including zero, tare, and printing
- Selectable over/under mode of operation for classifying
- Selectable material transfer mode of operation for simple filling or dosing
- Additional graphic display options include SmartTrac™, rate and discrete I/O status
- Graphical on-screen load-centering assistance (PowerDeck base only)
- ID mode for prompted transaction sequencing and data collection
- Tracking of material delivery rate
- Comparators – simple coincidence set points for comparison of weight or rate with absolute target values or ranges
- Two standard memory tables for Tare and Target storage – 99 Tare records and 200 Target records
- Unit switching between three different units, including a custom unit
- Alibi memory storage for up to 100,000 records
- Grand total and subtotal registers for accumulating weight
- Ten customizable print templates
- Report printing
- TraxDSP™ digital filtering for analog load cells
- TraxEMT™ performance monitoring and recording
- CalFree™ calibration without test weights
- Automatic load-cell addressing (POWERCELL only)
- Visual installation guidance for levelling a PowerDeck platform (POWERCELL only)
- Routine verification of system accuracy by utilizing Test Manager GWP® (Good Weighing Practice)
- MinWeigh™ to eliminate measurement uncertainties
- Support for the following communication options:
  - Ethernet TCP/IP
  - Additional serial ports, COM2 and COM3
  - Solid State or relay based discrete I/O interfaces
  - Analog output
  - ControlNet
  - DeviceNet™
  - EtherNet/IP
  - Modbus TCP
  - PROFIBUS® DP
  - PROFINET®
  - WiFi (dual band 2.4/5 GHz)

- Support for the following optional Application Software Modules:  
Fill-570      Drive-570      COM-570      DYN-570
- Support for TaskExpert™ custom application development software

## 1.2. Specifications

The IND570 terminal conforms to the specifications listed in Table 1-1.



**Table 1-1: IND570 Specifications**

IND570 Specifications	
Enclosure Types	Panel-mount stainless steel front panel with an aluminum frame
	Harsh environment desk/wall/column-mount type 304L stainless steel enclosure
Dimensions (l × w × d)	Panel Mount: 265 mm × 160 mm × 66.5 mm (10.4 in. × 6.3 in. × 2.6 in.)
	Harsh Environment: 265 mm × 148.4 mm × 163 mm (10.4 in. × 5.8 in. × 6.4 in.)
Shipping Weight	3.2 kg (7 lb)
Environmental Protection	Panel-mount front panel sealing is UL-approved and certified to IP65, type 4x and type 12
	IND570 Harsh Environment model: UL-approved and certified to IP69K. IND570xx: IP65.
Operating Environment	All terminal types can be operated at temperatures ranging from –10° to 40° C (14° to 104° F) at 10% to 95% relative humidity non-condensing
Hazardous Areas	<b>Only</b> the IND570xx version is certified for use in environments classified as Division 2 or Zone 2/22 because of the combustible or explosive atmospheres in those areas.
AC Input Power (Harsh and panel-mount models)	Operates at 85–264 VAC, 49–61 Hz, 500 mA
	Panel-mount version provides a terminal strip for AC power connections.
	Harsh environment version includes a power cord configured for the country of use. The IND570xx version provides conduit hubs and no power cord for Canadian and US approved applications, and an open-ended power cord for ATEX and IECEx approved applications.
	<b>Note:</b> When an IND570xx is installed in an area classified as Division 2 or Zone 2/22, special AC wiring requirements must be met. Refer to document 30205321
DC Input Power (Panel-mount models only; not for POWERCELL model)	Operates at 24 VDC, -15% - +20%, 1.25A
	Provides a terminal strip for DC power connections
	24VDC input power option not available on the harsh models







<b>IND570 Specifications</b>	
<b>Scale Types &amp; Update Rates</b>	Analog load cells, up to twelve 350-ohm load cells (eight for IND570xx) (2 or 3 mV/V). Update rate > 366 Hz. or IDNet High-Precision Line (+12V versions only, including T-Brick cell, M-Cell, Point-ADC). Update rate determined by IDNet base. or SICSpro High-precision platforms that include Advanced Setup Mode. Refer to section 1.8.1.3 for details. Update rate approximately 90 Hz. or Up to 14 POWERCELL load cells for IND570, and up to 6 POWERCELL load cells for IND570xx, or single PowerDeck platform. Update rate selectable up to 50 Hz.
<b>Analog Load Cell Excitation Voltage</b>	10 VDC
<b>Minimum Sensitivity</b>	0.1 microvolts
<b>Weight Display</b>	Displayed resolution of 100,000 counts for analog load cell scales. Display resolution for high-precision IDNet and SICSpro bases is determined by the specific base used.
<b>Interface and Function Update Rates (max) – Analog terminal versions</b>	Weight display: 10 Hz Internal discrete I/O: 50 Hz External discrete I/O (ARM100): 25 Hz PLC cyclic data: 25 Hz SICS continuous (SIR): 20 Hz MT Continuous Output: 20 Hz Continuous Template (serial): 20 Hz (19.2-115.2Kbaud), 14 Hz (9600 baud) Continuous Template (Eprint): 10 Hz
<b>Interface and Function Update Rates (max) – IDNet terminal versions</b>	Weight display: 10 Hz Internal discrete I/O: 20 Hz External discrete I/O (ARM100): 20 Hz PLC cyclic data: 20 Hz SICS continuous (SIR): 20 Hz MT Continuous Output: 20 Hz Continuous Template (serial): 20 Hz (19.2-115.2Kbaud), 14 Hz (9600 baud) Continuous Template (Eprint): 10 Hz
<b>Interface and Function Update Rates (max) – SICSpro terminal versions</b>	Weight display: 10 Hz Internal discrete I/O: 50 Hz External discrete I/O (ARM100): 25 Hz PLC cyclic data: 25 Hz SICS continuous (SIR): 20 Hz MT Continuous Output: 20 Hz Continuous Template (serial): 20 Hz (19.2-115.2Kbaud), 14 Hz (9600 baud) Continuous Template (Eprint): 10 Hz

<b>IND570 Specifications</b>									
<b>Interface and Function Update Rates (max) – POWERCELL terminal versions</b>	Weight display: 10 Hz Internal discrete I/O: 50 Hz External discrete I/O (ARM100): 25 Hz PLC cyclic data: 20 Hz SICS continuous (SIR): 20 Hz (15 Hz when update rate is 15 Hz) MT Continuous Output: 20 Hz (15 Hz when update rate is 15 Hz) Continuous Template (serial): 20 Hz (19.2-115.2Kbaud), 14 Hz (9600 baud) (15 Hz when update rate is 15 Hz) Continuous Template (Eprint): 10 Hz								
<b>Keypad</b>	26 keys; 1.22-mm thick polyester overlay (PET) with polycarbonate display lens. IND570xx version provides an additional 1-mm thick clear polyester overlay (PET) in front of the polycarbonate display lens								
<b>Communication</b>	<p><b>Standard Interfaces</b></p> Serial Port: COM1 (RS-232/RS-422/RS-485), 300 to 115,200 baud (isolated, in POWERCELL models) Serial Port: COM4 (POWERCELL models only) RS-232, 300 to 115,200 baud USB Host Port: Type A connector, +5V at 100mA for connected devices (not certified for use in hazardous areas)								
	<p><b>Optional Interfaces</b></p> Ethernet Port: Ethernet 10 base-T / 100 base TX COM2 serial port: RS-232, 300 to 115,200 baud COM3 serial port: RS-232/RS-422/RS-485, 300 to 115,200 baud WiFi (WLAN, dual band, 2.4 and 5 GHz)								
	<p><b>Supported Protocols</b></p> USB Inputs: ASCII characters (barcode, keyboard), on-demand file import USB Outputs: Demand output, Report printing, on-demand file export Serial Inputs: ASCII characters, ASCII commands for CTPZ (Clear, Tare, Print, Zero), SICS (level 0 and level 1, some support for level 2 commands), Remote Display, Shared Data Server access Serial Outputs: Continuous and Demand outputs, SICS host protocol, report printing, interfaces with external ARM100 Remote Input/Output modules. Optional COM-570 Application Software available for legacy serial protocols. Ethernet Inputs: ASCII commands for CTPZ (Clear, Tare, Print, Zero), SICS (level 0 and level 1, some support for level 2 commands), Remote Display, Shared Data Server Access Ethernet Outputs: Continuous and Demand Outputs, report printing WiFi Inputs: Remote Display, SICS host protocol, Shared Data Server Access, FTP WiFi Outputs: Demand output								
	<p><b>PLC Interfaces</b></p> A single interface supported: Analog output, ControlNet, DeviceNet, EtherNet/IP, Modbus TCP, PROFIBUS DP, PROFINET								
<b>WiFi</b>	<table border="1"> <tbody> <tr> <td style="text-align: center;">Bands</td> <td>Dual-band, 2.4 and 5 GHz</td> </tr> <tr> <td style="text-align: center;">WiFi Standards</td> <td>IEEE 802.11a/b/g/n</td> </tr> <tr> <td style="text-align: center;">WiFi Output Power</td> <td>Max. 15 dBm</td> </tr> <tr> <td style="text-align: center;">Transmission Range</td> <td>Up to 150 m (500 ft)</td> </tr> </tbody> </table>	Bands	Dual-band, 2.4 and 5 GHz	WiFi Standards	IEEE 802.11a/b/g/n	WiFi Output Power	Max. 15 dBm	Transmission Range	Up to 150 m (500 ft)
Bands	Dual-band, 2.4 and 5 GHz								
WiFi Standards	IEEE 802.11a/b/g/n								
WiFi Output Power	Max. 15 dBm								
Transmission Range	Up to 150 m (500 ft)								

IND570 Specifications																				
	Max. Transfer Rates	IEEE 802.11a/g: 54 Mbit/s IEEE 802.11b: 11 Mbit/s IEEE 802.11n: 130 Mbit/s (MIMO), 65Mbit/s (SISO)																		
	Antenna	Internal																		
	Connection	USB 2.0 (bus-powered device)																		
	Security	WiFi Enterprise: WEP 64/128; WPA and WPA2; TKIP and AES/CCMP hardware accelerator; LEAP, PEAP, EAP-TLS																		
	Approvals	<table style="width: 100%; border-collapse: collapse;"> <tr> <td style="width: 50%;">Europe</td> <td>ETSI R&amp;TTE, RED</td> </tr> <tr> <td>US</td> <td>FCC/CFR 47 part 15 unlicensed modular transmitter approval</td> </tr> <tr> <td>Canada</td> <td>IC RSS</td> </tr> <tr> <td>Japan</td> <td>MIC</td> </tr> <tr> <td>Taiwan</td> <td>NCC</td> </tr> <tr> <td>China</td> <td>SRCC</td> </tr> <tr> <td>Turkey</td> <td>ETSI R&amp;TTE, RED</td> </tr> <tr> <td>Switzerland</td> <td>ETSI R&amp;TTE, RED</td> </tr> <tr> <td>Hong Kong</td> <td>[None required]</td> </tr> </table>	Europe	ETSI R&TTE, RED	US	FCC/CFR 47 part 15 unlicensed modular transmitter approval	Canada	IC RSS	Japan	MIC	Taiwan	NCC	China	SRCC	Turkey	ETSI R&TTE, RED	Switzerland	ETSI R&TTE, RED	Hong Kong	[None required]
Europe	ETSI R&TTE, RED																			
US	FCC/CFR 47 part 15 unlicensed modular transmitter approval																			
Canada	IC RSS																			
Japan	MIC																			
Taiwan	NCC																			
China	SRCC																			
Turkey	ETSI R&TTE, RED																			
Switzerland	ETSI R&TTE, RED																			
Hong Kong	[None required]																			
<b>Approvals</b>	<p><b>Weights and Measures</b>            USA: NTEP Class II 100,000d; Class III/IIIL 10,000d; CoC #13-123            Canada: Class II 100,000d; Class III 10,000d; Class IIIHD, 20,000d; AM-5933            Europe: OIML R76 Class II approved divisions determined by platform; Class III and IIII 10,000e; T11060/TC8458. MID R61 (Automatic Gravimetric Filling Instrument); T10610. MID R51 (Automatic Catchweigher); T10609.</p> <p><b>Product Safety</b>            UL, cUL, CE</p> <p><b>Hazardous Area (IND570xx models only)</b></p> <table style="width: 100%; border-collapse: collapse;"> <tr> <td style="width: 30%;">US</td> <td style="width: 40%;">CL I, DIV 2, GP CD; CL II, DIV2, GP FG; CL III; CL I Zn 2 IIB T5; Zn 22 IIIC T85°C -10°C ≤ Ta ≤ +40°C Temperature ID = T5 (100°C)</td> <td style="width: 30%; text-align: right;">IP65</td> </tr> <tr> <td>Canada</td> <td>CL I, DIV 2, GP CD; CL II, DIV2, GP FG; CL III; -10°C ≤ Ta ≤ +40°C Temperature ID = T5 (100°C)</td> <td style="text-align: right;">IP65</td> </tr> <tr> <td>Europe</td> <td>  II 3 G Ex ic nA [ic] IIB T5 Gc -10°C ≤ Ta ≤ +40°C            II 3 D Ex tc IIIC T85°C Dc -10°C ≤ Ta ≤ +40°C         </td> <td style="text-align: right; vertical-align: top;">IP65</td> </tr> <tr> <td>IECEX</td> <td>Ex ic nA [ic] IIB T5 Gc -10°C ≤ Ta ≤ +40°C Ex tc IIIC T85°C Dc -10°C ≤ Ta ≤ +40°C</td> <td style="text-align: right; vertical-align: top;">IP65</td> </tr> </table>		US	CL I, DIV 2, GP CD; CL II, DIV2, GP FG; CL III; CL I Zn 2 IIB T5; Zn 22 IIIC T85°C -10°C ≤ Ta ≤ +40°C Temperature ID = T5 (100°C)	IP65	Canada	CL I, DIV 2, GP CD; CL II, DIV2, GP FG; CL III; -10°C ≤ Ta ≤ +40°C Temperature ID = T5 (100°C)	IP65	Europe	 II 3 G Ex ic nA [ic] IIB T5 Gc -10°C ≤ Ta ≤ +40°C II 3 D Ex tc IIIC T85°C Dc -10°C ≤ Ta ≤ +40°C	IP65	IECEX	Ex ic nA [ic] IIB T5 Gc -10°C ≤ Ta ≤ +40°C Ex tc IIIC T85°C Dc -10°C ≤ Ta ≤ +40°C	IP65						
US	CL I, DIV 2, GP CD; CL II, DIV2, GP FG; CL III; CL I Zn 2 IIB T5; Zn 22 IIIC T85°C -10°C ≤ Ta ≤ +40°C Temperature ID = T5 (100°C)	IP65																		
Canada	CL I, DIV 2, GP CD; CL II, DIV2, GP FG; CL III; -10°C ≤ Ta ≤ +40°C Temperature ID = T5 (100°C)	IP65																		
Europe	 II 3 G Ex ic nA [ic] IIB T5 Gc -10°C ≤ Ta ≤ +40°C II 3 D Ex tc IIIC T85°C Dc -10°C ≤ Ta ≤ +40°C	IP65																		
IECEX	Ex ic nA [ic] IIB T5 Gc -10°C ≤ Ta ≤ +40°C Ex tc IIIC T85°C Dc -10°C ≤ Ta ≤ +40°C	IP65																		

## 1.3. Environmental Protection

	 <b>WARNING</b>
	VERSIONS OF THE IND570 TERMINAL THAT ARE NOT FACTORY-LABELED AS DIVISION 2 OR ZONE 2/22 MUST NOT BE INSTALLED INTO A DIVISION 2 OR ZONE 2/22 ENVIRONMENT.
	 <b>WARNING</b>
	THE IND570xx TERMINAL IS NOT INTRINSICALLY SAFE LEVEL "a" OR "b"! DO NOT USE WITHIN AREAS CLASSIFIED AS HAZARDOUS DIVISION 1 OR ZONE 0/1/20/21 BECAUSE OF COMBUSTIBLE OR EXPLOSIVE ATMOSPHERES. FAILURE TO COMPLY WITH THIS WARNING COULD RESULT IN BODILY HARM AND/OR PROPERTY DAMAGE.

When an approved version IND570xx is installed in an area classified as Division 2 or Zone 2/22, special AC wiring requirements must be met. Refer to document 30205321, **IND570xx Division 2, Zone 2/22 Installation Guide**.

## 1.4. Inspection and Contents Checklist

Verify the contents and inspect the package immediately upon delivery. If the shipping container is damaged, check for internal damage and file a freight claim with the carrier if necessary. If the container is not damaged, remove the IND570 terminal from its protective package, noting how it was packed, and inspect each component for damage.

If shipping the terminal is required, it is best to use the original shipping container. The IND570 terminal must be packed correctly to ensure its safe transportation.

The package should include:

- IND570 terminal
- Safety warnings in multiple languages
- Fixed angle mounting brackets (harsh models only)
- Bag of ATEX certified glands for IND570xx harsh versions with ATEX/IECEx approval
- Bag of parts for installation. Depending on terminal, may include ferrites, grommets, rubber feet, sealing gasket, etc.
- European Certificate of Conformance (Europe only)

# 1.5. Model Identification

The IND570 model number is located on the data plate on the back of the terminal along with the serial number and SCK (configuration number). Figure 1-1 shows the SCK for the standard IND570 and Figure 1-2 the SCK for the IND570xx version.

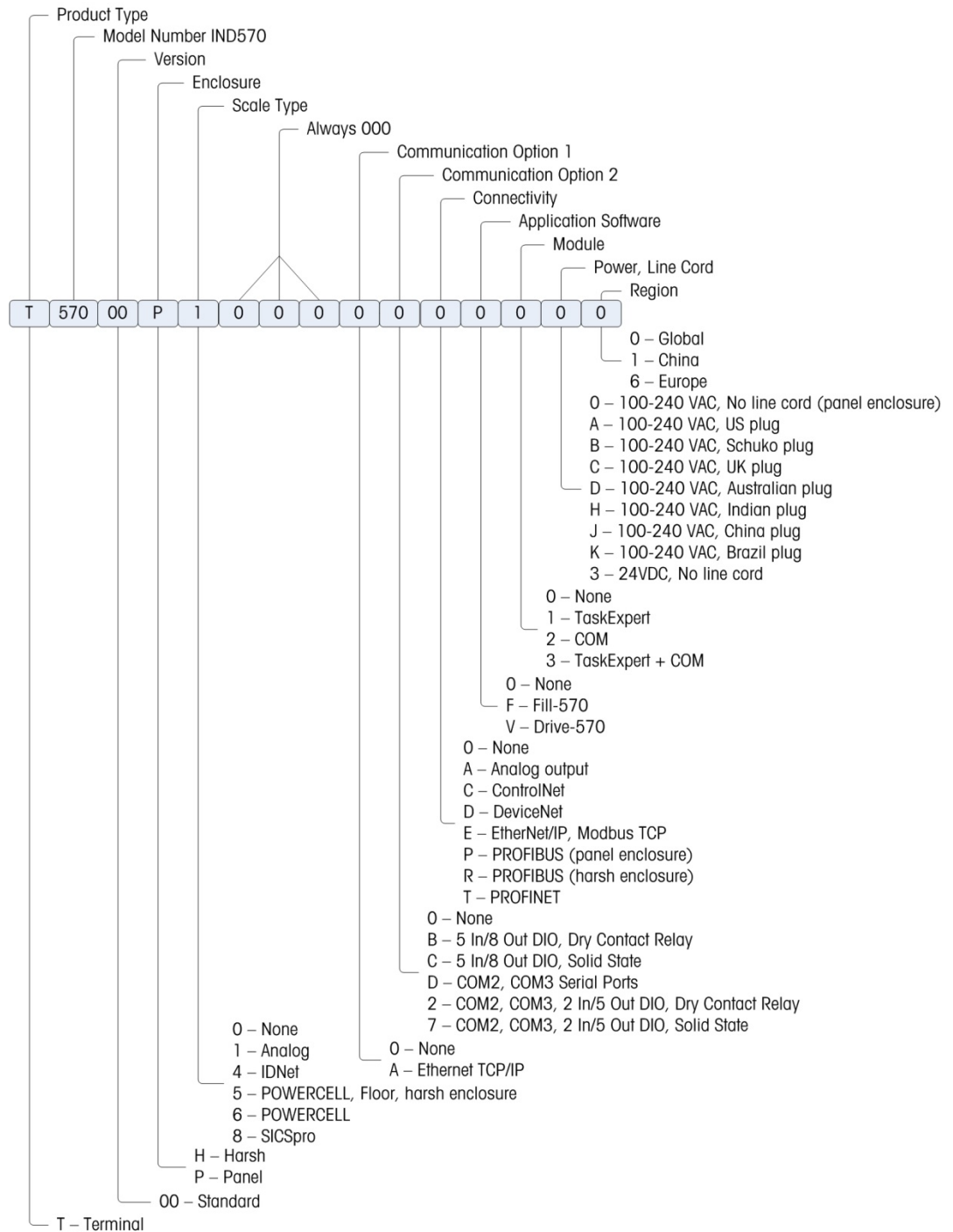
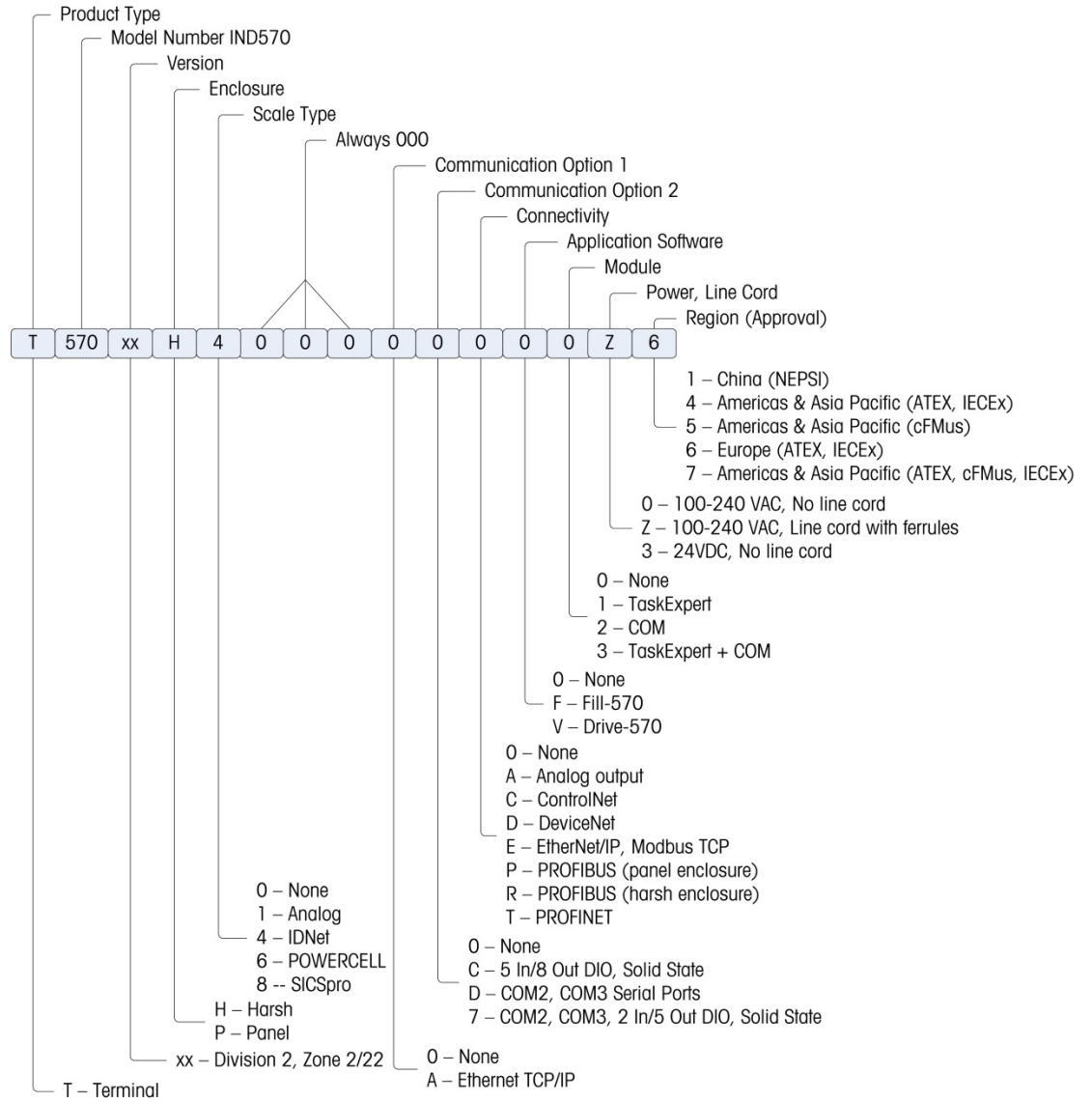

Figure 1-1: IND570 SCK Identification



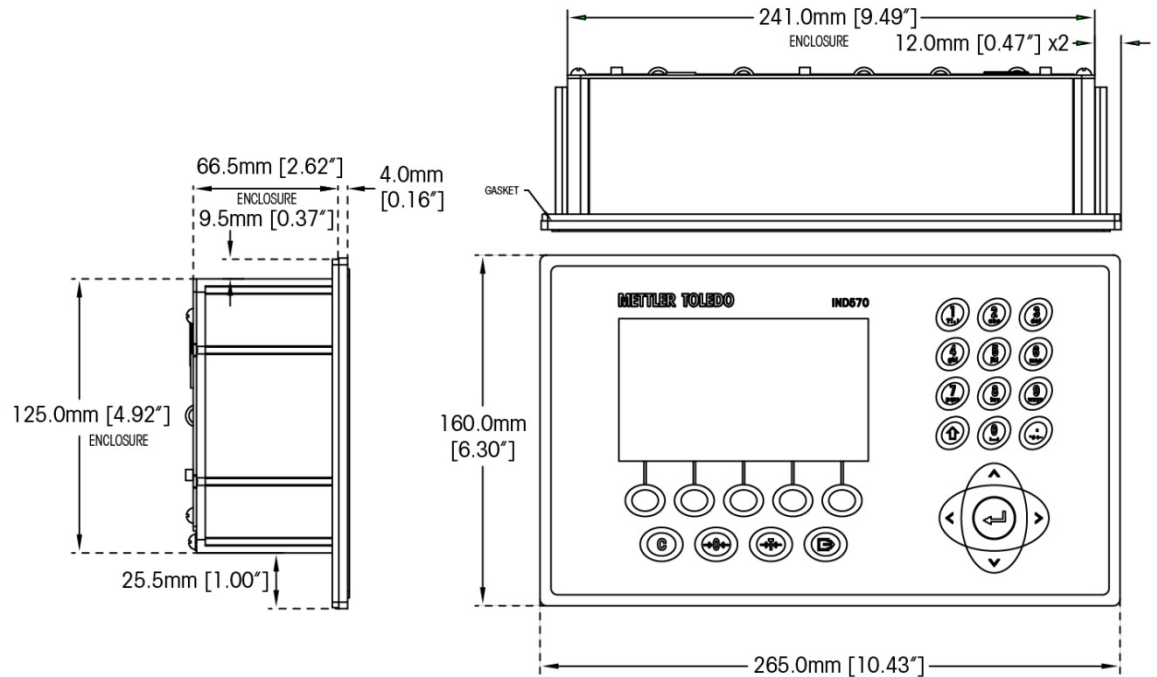

**Figure 1-2: IND570xx SCK Identification**

# 1.6. Physical Dimensions

## 1.6.1. Panel Mount Enclosures, IND570 and IND570xx

The physical dimensions of the Panel Mount IND570 and IND570xx enclosures are shown in Figure 1-3 in millimeters and [inches]. Figure 1-4 shows the dimensions of the cutout required for the Panel Mount enclosure.



**Figure 1-3: IND570 Panel Mount Enclosure Dimensions**

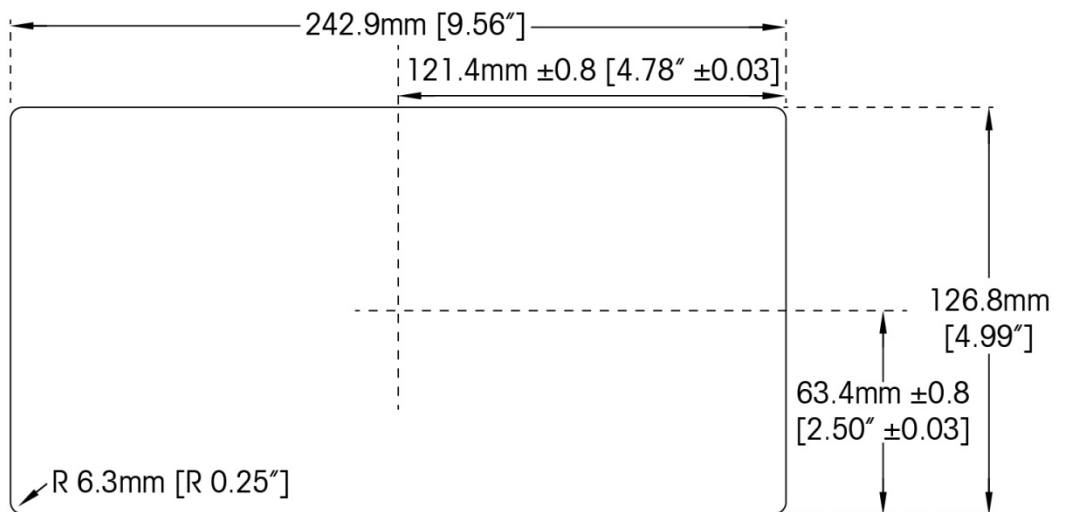
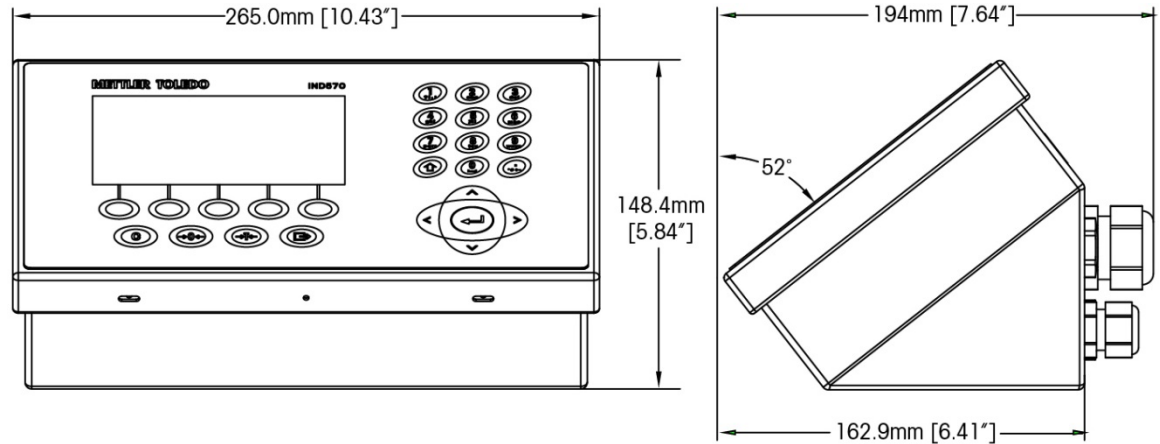

**Figure 1-4: IND570 Panel Mount Cutout Dimensions**

## 1.6.2. Harsh Environment Enclosures, IND570 and IND570xx

### 1.6.2.1. IND570

The dimensions of the harsh enclosure desk/wall-mount IND570 terminal are shown in Figure 1-5 and Figure 1-7 in millimeters and [inches].



**Figure 1-5: IND570 Harsh Environment Enclosure Dimensions**

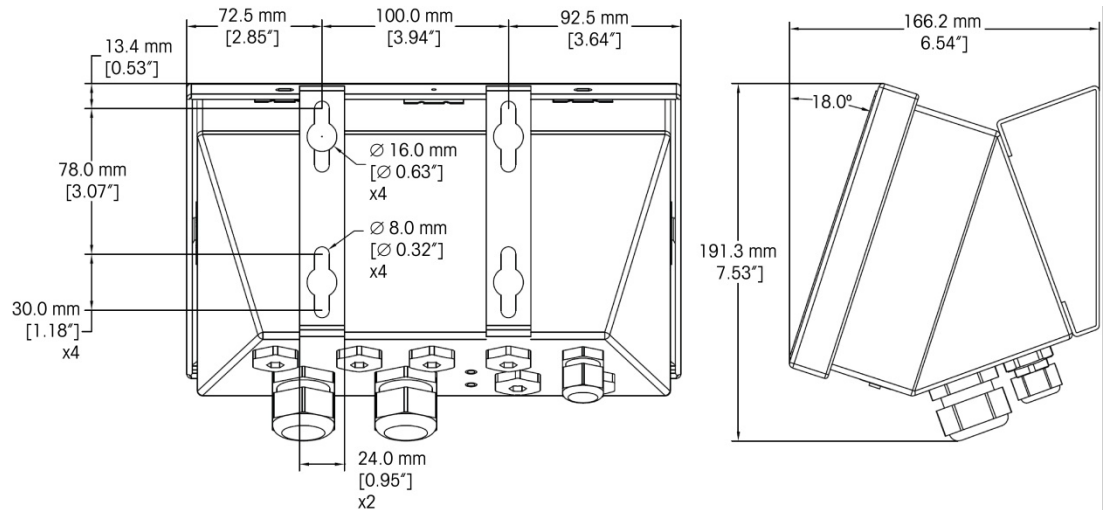

**Figure 1-6: IND570 Harsh Environment Enclosure Dimensions with Fixed Angle Mounting Brackets, VESA Mounting**

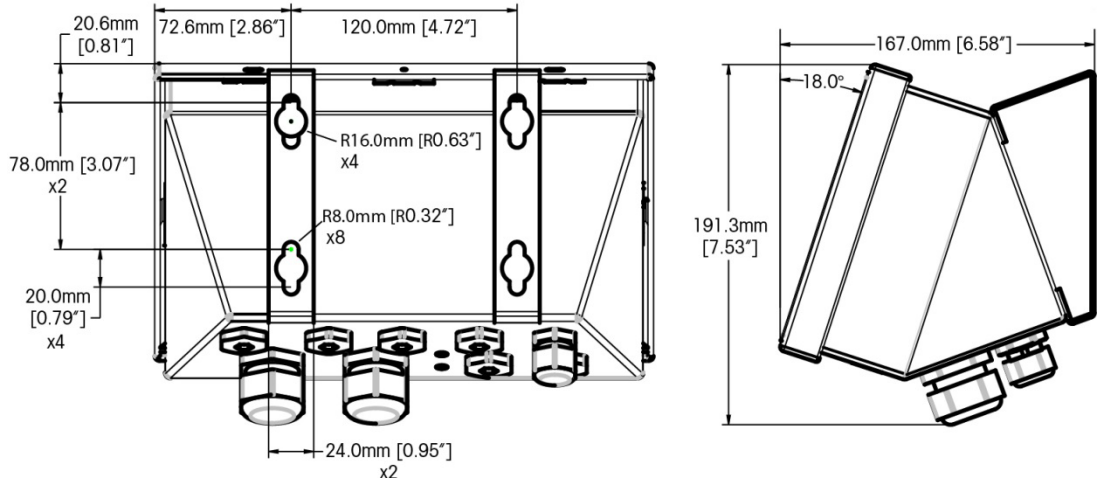

**Figure 1-7: IND570 Harsh Environment Enclosure Dimensions with Fixed Angle Mounting Brackets, Original Mounting**

**1.6.2.2. IND570xx**

The dimensions of the harsh enclosure desk/wall-mount IND570xx terminal are shown in Figure 1-8 and Figure 1-9 in millimeters and [inches].

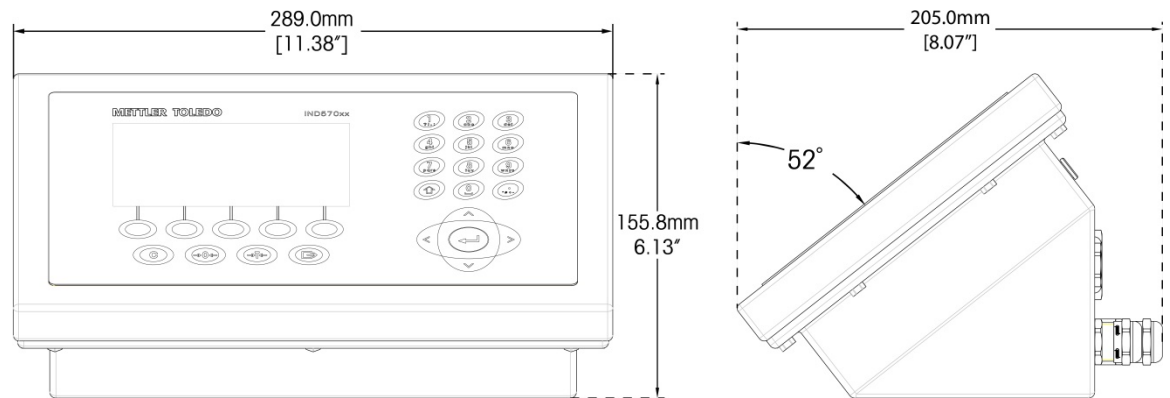

**Figure 1-8: Harsh Environment Enclosure Dimensions, IND570xx**

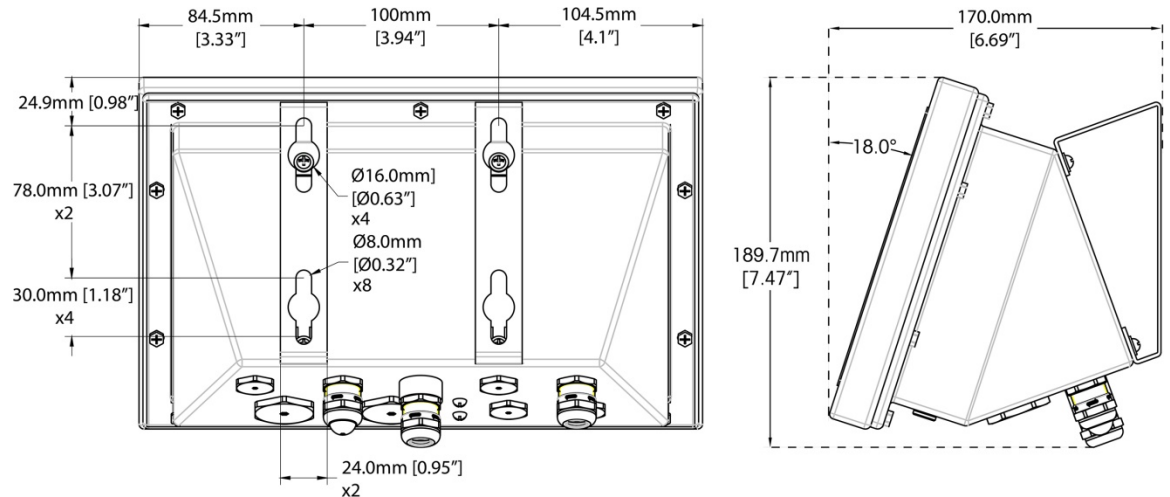

**Figure 1-9: Harsh Environment Enclosure Dimensions with Fixed Angle Mounting Brackets for VESA Mounting**

## 1.7. Main PCB

The IND570 and IND570xx terminals' main printed circuit board (PCB) provides the interface for analog scales/load cell(s), SICSpro platforms, IDNet platforms or POWERCELL load cells/PowerDeck platforms.

The main board also contains the USB Host port for connection of an external keyboard or barcode scanner for data entry or a USB memory device that can be used for data collection, file transfer and system backup. The USB port is also used to connect the WiFi option.

	 <b>WARNING</b>
	<b>THE USB INTERFACE IS NOT CERTIFIED FOR USE IN DIVISION 2 OR ZONE 2/22 HAZARDOUS AREAS. USE ONLY IN SAFE AREA.</b>

A single standard serial port (COM1; isolated in the IND570 and IND570xx POWERCELL versions) is located on the main board and provides RS-232, RS-422, or RS-485 communication. The COM1 port is bidirectional and can be configured for various functions such as demand output, remote display, SICS host communications, continuous output, ASCII command input (C, T, P, Z), ASCII character input, report printing, totals printing, or connection to an ARM100 remote I/O module.

The IND570 and IND570xx POWERCELL versions also include an isolated COM4 port that provides RS-232 communication.

The main board also contains an input from the AC (or DC) power supply, front panel keyboard interface, and bus connectors for the option boards.

Current limiting for the IND570xx version is also located on the main board.



## 1.8. Scale Types

The IND570 supports three types of scale:

### 1.8.1.1. Analog Load Cell Scale

The IND570 main PCB includes an analog load cell interface. The terminal can drive up to twelve 350-ohm analog load cells (eight for IND570xx). The analog load cell interface is approved by ATEX, cFMus, and IECEx for use in the IND570xx.

### 1.8.1.2. IDNet™ Scale Platform

The IND570 supports an IDNet scale through a PCB interface that connects to a unique bus on the main board. This interface supports the newer T-brick style of high-precision base through the IDNet scale card. The port provides the +12 volts and communication required to operate this newer style base. The interface also supports M-Cell and Point-ADC. The older PIK module and PIK-brick cells require +32 volts and are not supported by the IND570. The IDNet scale interface is approved for use in the IND570xx version with ATEX and IECEx certification.

### 1.8.1.3. SICSpro Scale Platform

The IND570 supports a SICSpro platform through a PCB interface that connects to a unique bus on the main board. This interface supports the high-precision platform types through the SICSpro scale card. The port provides the +12 volts and communication required to operate these newer style platforms.

The IND570 SICSpro interface supports **only** those SICSpro platforms that include the Advanced Setup Mode (ASM).

Table 1-2 lists SICSpro high-precision platforms that support ASM and can interface with the IND570 and IND570xx terminals, as of December 2017. Please note that the SICSpro platform software may need updated before successful communication will occur with the IND570. Details on updating the platform software can be found in Chapter 5, **Service and Maintenance**.

**Table 1-2: Supported SICSpro Platforms**

Terminals - Configuration	PBA430 with SICSpro option	PBA757 with SICSpro option	PTA/PUN/PA with SICSpro option	PBA769	Safe Area Installations	PDB655 6 kg - B60 kg	PDB655 > B60 kg	PBD555	PBK785	PBK989 XS.0.6	PBK9/PPK9	PBK9/PPK9 with Div. 2, Cat. 3 option
IND570 with SICSpro Scale Interface												n/a
IND570 with IDNet Scale Interface and ACC409xx Accessory										*	*	n/a
<b>Division 2 and Category 3 (Zone 2/22) Installations</b>												
IND570 with SICSpro Scale Interface	Not applicable for Division 2 & Category 3 (Zone 2/22) Installations											
IND570 with IDNet Scale Interface and ACC409xx Accessory	Not applicable for Division 2 & Category 3 (Zone 2/22) Installations											

	Allowed for approved and non-approved applications (OIML and NTEP)
	Do not connect. May cause damage to the weighing platform
*	Maximum 30,000e allowed for 600g platforms

**1.8.1.3.1. Cable-Free Floor Scale**

A cable-free SICSpro floor scale option (ACW520) offers BlueTooth connectivity to the IND570 via a module connected to the IND570 SICSpro's M12 scale port. The module is provided with the Cable-Free Floor Scale platform as part of the ACW520 option.

- Only IND570 terminals running firmware 2.00.0086 or later are compatible with the ACW520 option.

**1.8.1.4. POWERCELL Scale Platform**

The main PCB on IND570 POWERCELL and IND570xx POWERCELL terminals includes a POWERCELL load cell interface.

- The IND570 POWERCELL terminal can drive up to 14 POWERCELL PDX or GDD load cells, or up to 14 SLB615D or SLC611D load cells.
- The IND570xx POWERCELL terminal can drive up to 6 POWERCELL PDX or GDD load cells, or up to 6 SLB615D or SLC611D load cells.
- The POWERCELL interface on IND570 POWERCELL and IND570xx POWERCELL terminals also supports a single PowerDeck platform, which consists of 4 POWERCELL load cells.

**1.8.1.4.1. POWERCELL Network**

The POWERCELL is typically found in vehicle scale applications. It operates on a digital communications network using CANbus. The IND570 supports up to a maximum of 14

POWERCELL cells (maximum of 6 POWERCELL cells in IND570xx) from its internal power supply. An external power supply to power additional cells is not supported. If more than 14 cells are needed, the IND780 PDX terminal must be used.

When used as part of a PDX cell network, the IND570 provides several diagnostic features such as automated alerts and cell performance monitoring. These features help lower maintenance costs and minimize downtime.

#### 1.8.1.4.2. Isolated Serial Ports

The IND570 is designed for use in environments where the connecting cables may be exposed to lightning surges. To help protect the terminal from damage, the COM1 and COM4 serial port on the main board of the POWERCELL versions of IND570 and IND570xx are both electrically isolated. This eliminates the difference in ground levels that can damage the interface circuitry.

#### 1.8.1.5. **PowerDeck Scale Platform**

The POWERCELL-based PowerDeck platform provides an enhanced set of configuration and operational capabilities:

- Save and Restore of original platform system parameters stored in each load cell of a PowerDeck platform during initial factory configuration
- Visual Installation Guidance to assist technicians in leveling the platform during installation to achieve original factory specified performance
- Off-center Load Assistance to guide operators during platform use

## 1.9. Options

The following hardware and software options are available for the IND570:

- Discrete I/O
  - Internal, high-level and low-level discrete I/O
  - Remote discrete I/O via ARM100 module
- COM2/COM3 Serial Ports
- Ethernet TCP/IP Port
- Programmable Logic Control (PLC) interfaces, including:



Analog Output	ControlNet™	DeviceNet™	EtherNet/IP™
Modbus TCP	PROFIBUS® DP	PROFINET®	
- COM-570 application software
- Drive-570 application software
- DYN-570 application software
- Fill-570 application software
- TaskExpert™ custom application development software

- USB and Ethernet adapters that make these ports accessible on the exterior of the harsh enclosure. These options are not certified for use on the IND570xx version
- WiFi (dual band 2.4/5 GHz) – internal, or remotely mounted
- Positionable brackets for wall and column mounting of the harsh enclosure
- InSite™ SL Configuration Tool (PC based software for backup and restore)

### 1.9.1. Discrete I/O

The discrete I/O interface options include both internal and remote I/O. Only one internal discrete I/O option board can be installed at any one time.

- An internal dry-contact relay DIO option is available with 5 inputs and 8 outputs. Each output will switch up to 30 volts DC or 250 volts AC up to 1 amp of current. Voltages can be mixed on this local discrete I/O option. The inputs are switch-selectable as either active (for simple pushbutton control) or passive (for connection to PLCs or other devices that supply their own power for the I/O). This option is not available for the IND570xx version.
- Another internal dry-contact relay DIO/serial port option is available with 2 inputs, 5 outputs and the COM2 and COM3 serial ports. Each output will switch up to 30 volts DC or 250 volts AC up to 1 amp of current. Voltages can be mixed on this local discrete I/O option. The inputs are switch-selectable as either active (for simple pushbutton control) or passive (for connection to PLCs or other devices that supply their own power for the I/O). This option is not available for the IND570xx version.
- An internal solid state DIO option is available with 5 inputs and 8 outputs. Each output will switch up to 30 volts up to 1 amp of current. Voltages can be mixed on this local discrete I/O option. The inputs are switch-selectable as either active (for simple pushbutton control) or passive (for connection to PLCs or other devices that supply their own power for the I/O).
- Another internal solid state DIO/serial port option is available with 2 inputs, 5 outputs and the COM2 and COM3 serial ports. Each output will switch up to 30 volts DC up to 1 amp of current. Voltages can be mixed on this local discrete I/O option. The inputs are switch-selectable as either active (for simple pushbutton control) or passive (for connection to PLCs or other devices that supply their own power for the I/O).
- Remote I/O function is supported by the ARM100 remote I/O module. ARM100 modules offer 4 inputs and 6 outputs. This module provides only dry-contact outputs. The ARM100's inputs are passive. An external 10 to 32 VDC power supply is required to operate the ARM100. Either the COM1 or COM3 serial port is required for communication with an ARM100 module. A maximum of 3 ARM100 modules can be connected.
  - The COM3 serial port is available on the COM2/COM3 option or the COM2/COM3/DIO combination option.
- A maximum of 17 inputs and 26 outputs are supported (5 Inputs/8 Outputs local I/O option, and three ARM100 remote I/O modules).

	 <b>WARNING</b>
	<p><b>THE INTERNAL DISCRETE I/O RELAY OPTION #30113540, OR #30113542 MUST NOT BE USED IN AN IND570xx TERMINAL. FAILURE TO COMPLY WITH THIS WARNING COULD RESULT IN BODILY HARM AND/OR PROPERTY DAMAGE.</b></p>



## **WARNING**

**INTERNAL OR EXTERNAL DISCRETE I/O OPTIONS WITH DRY CONTACT RELAYS MUST NOT BE USED IN AREAS CLASSIFIED AS HAZARDOUS DUE TO THE PRESENCE OF COMBUSTIBLE OR EXPLOSIVE ATMOSPHERES. FAILURE TO COMPLY WITH THIS WARNING COULD RESULT IN BODILY HARM AND/OR PROPERTY DAMAGE.**

### **1.9.2. Ethernet Option**

The Ethernet option provides a TCP/IP port that can be used to transmit demand templates, continuous data, for direct access to data via a shared data server, to send email alerts and terminal status information, and FTP transfer of tare and target tables and complete setup files. It also provides a connection for backup and restore of the terminal's configuration using the METTLER TOLEDO InSite™ SL program.

The Ethernet port offers access to the IND570 Webserver via a customer's local network.

- If the Ethernet and the WiFi options are both installed, the WiFi option will be disabled. Only one of these interfaces can be installed.

### **1.9.3. COM2/COM3 Serial Ports**

Options for additional serial ports include a stand-alone COM2/COM3 option and COM2/COM3 bundled with discrete I/O. Only one option can be used at a time.

COM2 supports an RS-232 connection at communication rates from 300 to 115.2k baud.

COM3 supports an RS-232, RS-422, or RS-485 connection at communication rates from 300 to 115.2k baud.

The serial/discrete I/O combination option includes 2 discrete inputs and 5 discrete outputs. Refer to section 1.9.1 **Discrete I/O**, above, for details.

### **1.9.4. WiFi (dual band 2.4/5 GHz)**

Two field installed option kits are available to add WiFi connectivity to the IND570. The kits convert the USB port to WiFi using an "external" module. One kit is to be installed inside the harsh enclosure (with antenna access through a plastic housing and the other is intended for remote mounting for either the harsh or the panel enclosure.

The WiFi module does not reproduce the full functions of an IND570's wired Ethernet connection. The WiFi options provide the following connection types:

- Demand output
  - Remote display (full capability in the remote terminal only)
  - SICS host
  - FTP
  - Shared data server access
- If the Ethernet and the WiFi options are both installed, the WiFi option will be disabled. Only one of these interfaces can be installed.

## 1.9.5. PLC Interfaces

The IND570 PLC interface options include Analog Output, ControlNet, DeviceNet, EtherNet/IP, Modbus TCP, PROFIBUS DP, and PROFINET. Only one PLC option can be used at a time.

Additional details about each of these interfaces, the **IND570 PLC Interface Manual**, programming examples and profiles, can be found at [www.mt.com/IND570](http://www.mt.com/IND570).

### 1.9.5.1. Analog Output

Analog Output refers to the representation of an internal system variable using a proportional electrical signal. Analog Output can be used to transmit a measured value, such as the gross or net weight.

0-10 volt DC and 4-20 mA signals are provided. Only one signal can be used at a time.

### 1.9.5.2. ControlNet

The ControlNet option enables the IND570 terminal to communicate to ControlNet Programmable Logic Controllers (PLCs) through direct connection to the ControlNet network.

Due to space constraints, the ControlNet interface option can only be used with panel-mount versions of the IND570 terminals.

### 1.9.5.3. DeviceNet

The IND570 DeviceNet option enables the terminal to communicate to a DeviceNet network. DeviceNet is an RS-485-based network using CAN chip technology. This network was created for bit and byte-level devices. The network can be configured to run up to 500Kbits per second depending on cabling and distances. Messages are limited to 8 un-fragmented bytes. Any larger message must be broken up and sent in multiples. The IND570 implementation of DeviceNet does not support fragmented messages – all messages are 8 bytes or shorter. The network is capable of 64 nodes including the master, commonly called the scanner.

### 1.9.5.4. EtherNet/IP

This internally installed PCB module enables the IND570 terminal to communicate to EtherNet/IP Programmable Logic Controllers (PLCs) through direct connection to the EtherNet/IP network at either 10 or 100 Mbps speed. Both implicit messaging (real-time I/O messaging) and explicit messaging (message exchange) are supported by the IND570 software.

### 1.9.5.5. Modbus TCP

In IND570, the Modbus TCP is made available through the same internal PCB option that supports the EtherNet/IP protocol. Modbus/TCP is used to establish master-slave/client-server communication between intelligent devices. It is an open standard network protocol, widely used in the industrial manufacturing environment. The ModbusTCP protocol takes the Modbus instruction set and wraps TCP/IP around it.

### 1.9.5.6. PROFIBUS DP

The PROFIBUS option card enables the IND570 terminal to communicate to a PROFIBUS DP master according to DIN 19 245 and programmable logic controllers such as Siemens S7 series. The

IND570 PROFIBUS communication solution consists of this internally installed PCB module and software that resides in the IND570 terminal which implements the data exchange.

#### **1.9.5.7. PROFINET**

The PROFINET option card enables the IND570 terminal to communicate to a PROFINET master and programmable logic controllers such as Siemens S7 series. The IND570 PROFINET communication solution consists of this internally installed PCB module and software that resides in the IND570 terminal which implements the data exchange.

### **1.9.6. Application Software**

The following application software modules can be added to the IND570 to provide additional functionality for specific workplaces and weighing operations.

#### **1.9.6.1. COM-570**

The COM-570 option is a specialized software module solution focused on the needs of users utilizing legacy communication protocols or that have special command requirements. COM-570 maintains all of the standard features and functions of the standard IND570 in addition to the specific features and functions of the COM-570. It provides the following features and functions:

- Custom ASCII command template
- PT6S3 Protocol
- 8530 Host Protocol
- 8142 Host Protocol
- SMA Protocol

Additional information is available in the COM-570 manual, which can be downloaded from [www.mt.com/IND570](http://www.mt.com/IND570).

#### **1.9.6.2. Drive-570**

The Drive-570 option is a specialized application solution focused on simple Inbound-Outbound vehicle weighing requirements. Some features of this software include:

- Two modes of operation: Temporary Tare ID Weighing and Permanent Tare ID Weighing
- Ability to store up to 100 Permanent Tare IDs
- Totalization of Permanent Tare IDs
- One-Step processing of Temporary IDs
- Reprint of previous transaction ticket
- Inbound Weight, Date and Time available on both inbound and outbound tickets
- Storage of up to 2000 transactions
- Support for all IND570 standard languages

Additional information is available in the Drive-570 manual, which can be downloaded from [www.mt.com/IND570](http://www.mt.com/IND570).

#### **1.9.6.3. DYN-570**

The DYN-570 is a specialized application solution used for in-motion weighing of conveyor-born packages. DYN-570 is compatible with analog load cell based weighing conveyors. DYN-570 is

available in two forms: DYN-570 Basic (ExpressWeigh®) and DYN-570 Advanced (ExpressCheck®).

**ExpressWeigh** (DYN-570 Basic) is designed for random package weighing and allows for collection of additional package data to combine with the package weight. **ExpressCheck** (DYN-570 Advanced) is an in-motion check weighing application. It includes all of the functionality of the basic application, and adds the ability to perform three-zone over/under checkweighing, using ID information stored in the Target Table.

Additional information is available in the Dyn-570 manual, which can be downloaded from [www.mt.com/IND570](http://www.mt.com/IND570).

#### 1.9.6.4. **Fill-570**

The Fill-570 is a special application that can be added to the IND570 terminal to provide additional filling and dosing control. It provides control for the following filling sequences:

- Dose out to target
- Dose out with an automatic refill of supply material(s)
- Fill to target
- Fill with a dump to empty
- Blend (up to 6 materials)
- Blend (up to 6 materials) with a dump to empty

Additional features of this software include:

- Specialized discrete I/O assignments for stand-alone control of filling and dosing systems
- Storage of formulas (multiple material blends)
- As-needed scaling of formulas
- Process statistics (maximum cycle time, out of tolerance count, etc.)
- Supply material conservation to support waste reduction

Additional information is available in the Fill-570 manual, which can be downloaded from [www.mt.com/IND570](http://www.mt.com/IND570).

#### 1.9.7. **TaskExpert™**

TaskExpert functionality provides a way to modify the standard capabilities of an IND570 so that it more closely aligns with a customer's specific application requirements. TaskExpert is a combination of a programming visualization tool, an execution engine and the basic functionality of the terminal. Modifications may be made to the standard sequences of operation and additional functionality may be added to the basic operation of the terminal.

TaskExpert custom programs that were written for the IND560 terminal will function on the IND570. The TaskExpert software development tool provides a converter function for this purpose.

#### 1.9.8. **InSite™ SL Configuration Tool**

InSite™ SL is available to end users of IND570 terminals. The IND570 terminal can connect to a PC running InSite™ SL via Ethernet or Serial to provide the following functions:

- Saving terminal configuration, data tables and information logs to a local PC
- Loading a saved configuration to other terminals performing similar applications



- Restoring to a 'last known good state' for service purposes

## 1.10. Display and Keyboard

Originally, the IND570 provided an organic LED (OLED) display. This has recently been changed to a TFT LCD display. Both displays are 256 x 128 dot matrix graphic types.

An example of the IND570 front panel is shown in Figure 1-10.

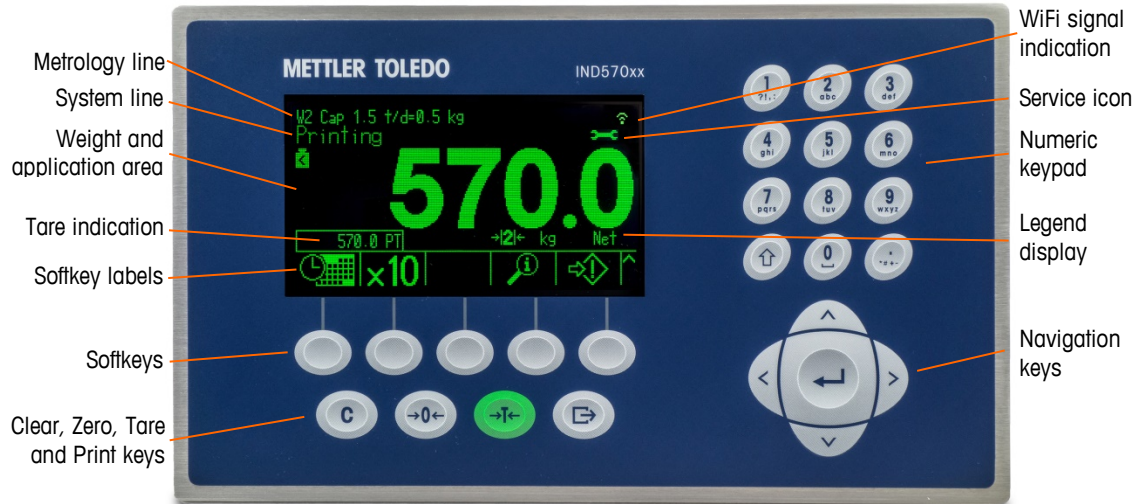

Figure 1-10: IND570 Front Panel Layout

### 1.10.1. Display Layout

- A **metrology line** is designed to show the capacity and increment size information for the scale. This line is always shown except when in the setup mode. If multiple ranges are selected, this line will scroll through each of the available capacities and ranges. The metrology line can be enabled/disabled in Setup.
- The **WiFi signal graphic** is located to the right of the metrology line and indicates if the WiFi module is connected to a wireless access point or not and, if it is connected, how strong the signal is. The symbols are:

✘	Not connected	📶	Acceptable signal
▪	Very weak signal	📶	Strong signal
📶	Weak signal		

- The **system line** is used to display system messages, messages sent remotely from a PLC, and any asynchronous error messages.
- The **Service Icon** graphic is shown in the system line when specific service events are triggered in the terminal. Details of what has triggered the Service Icon can be found by pressing the INFORMATION RECALL softkey ⓘ and then the SERVICE ICON 🔧 softkey.

- The middle portion of the display is reserved for the **weight display**. If the **auxiliary display** is enabled, this area of the display is shared between the weight display and the selection for auxiliary display (Figure 1-11, Figure 1-12, Figure 1-13). Random data entry is also shown in the bottom of this area.



Figure 1-11: Small Material Transfer SmartTrac Enabled

- SmartTrac is one of the available options for the auxiliary display. If SmartTrac is disabled, the weight display area can be shared with the **Rate display** (Figure 1-12) or **DIO status display** (Figure 1-13).



Figure 1-12: Rate Display

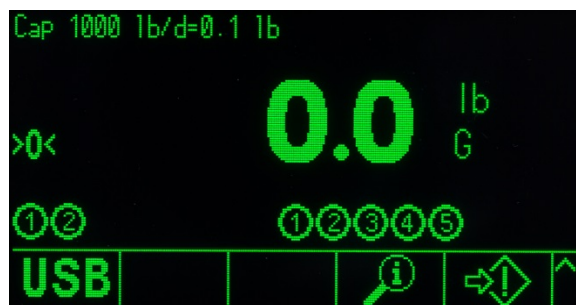

Figure 1-13: DIO Status Display

- The **Tare display** is designed to show the current Tare value and type (pushbutton or preset). The Tare display can be separately enabled and disabled in Setup.
- The **Legend display** area provides the user with current operational information such as center of zero status, gross or net mode, etc.
- The very bottom of the physical display area is reserved for showing the **graphic labels (icons) for the softkeys**. Display positions for up to five softkey icons are provided. Chapter 2,

**Operation**, provides more detailed information about all home screen softkeys, in the **Softkeys and Icons** section.

- To the right of the softkey icon area, space is reserved for MORE UP (▲) or MORE DOWN (▼) symbols. If present, these indicate additional softkey selections are available by pressing the UP or DOWN navigation keys. Up to 15 softkeys, presented in three sets of five, can be programmed for the home position, depending upon the weighing options and terminal functions enabled. The softkey setup and key mapping capabilities of the terminal determine the row and position of each softkey.

### 1.10.2. **Front Panel Keys**

Four dedicated scale function keys are located below the five softkeys. These provide the interface to zero and tare the scale, clear a tare or data entry, and to initiate a print.

The terminal's 12-key alphanumeric keypad is used to enter data and commands. The alphanumeric keys are located on the upper-right side of the terminal front panel. Refer to Chapter 2, **Operation**, for additional details about the entry of alphanumeric data.

Five navigation keys are located below the alphanumeric keypad. These keys enable the operator to navigate through setup options in the menu tree and within setup and application screens.

# 2 Operation

## 2.1. Overview

This chapter covers

- User Security
- Terminal HMI
- Data Entry
- Standard Features and Functions
- USB Host
- Error Management, Diagnostics and Service Options

This chapter provides information about navigation, basic features and functions, user notifications, easy file transfer and report generation using the IND570 terminal.

Specific operation of each IND570 terminal depends on enabled functions and parameters that are configured in setup. Individual setup parameters are described in Chapter 3, **Configuration**. Configuration and operation of some of the more complex terminal applications are further detailed in Chapter 4, **Applications**.

## 2.2. User Security

It is often required that equipment access or use be limited according to the security clearance of the user. These limitations may be due to legal regulations or to customer preference. Some installations operate in a “trusted” environment, where security is managed within the scope of the operation perimeter and no additional security is required from the weighing terminal. The opposite extreme may be found in highly regulated industries where every operation must be recorded and authorized by signature or login.

- The IND570 supports four levels of user security that rely on appropriate username/password entry for access to setup and terminal functions accessible from the home screen. Refer to Appendix A **Default Settings**, to determine security levels assigned to specific setup parameters and home screen functions.

**Administrator** An Administrator has unlimited access to all areas of the operating and setup system. Multiple Administrator accounts can be defined; however, the Primary Administrator account can be changed but never deleted.

At the factory, the terminal is configured with a Primary Administrator account with a username of **admin**. The factory default password is null (no password). This account’s username cannot be changed, but a password can be added or modified. As configured at the factory, the terminal requires no login or password entry to access setup mode.

- Even if additional username/password combinations are created, all functions of the terminal are available to all users until a password is programmed for the Primary Administrator account.

- Maintenance**      Access can be limited by assigning this security level to a user.
- Supervisor**        Access can be limited by assigning this security level to a user.
- Operator**            One default operator account with a username of **anonymous** and password null (no password) is provided. Sites with validation requirements might create many operator accounts, each with a username and password entry requirement.

When the Metrology switch (SW1-1) is turned “on” (refer to section 2.2.2) and a region approval is selected in setup, all users with Administrator rights are reduced to the Maintenance level. This is done to protect metrologically significant parameters that cannot be changed when the terminal is approved.

- When setting a password for a user, be sure to remember it and protect it from access by unauthorized personnel. If the password is changed or forgotten, access to the setup menu and some terminal functions will be lost. To regain access and functionality, a master reset of the terminal must be performed. This will reset all username and passwords, but also remove any custom configuration.

### 2.2.1. Accessing Setup and Terminal Functions

When a password has been programmed for the Primary Administrator username (refer to Chapter 3, the **Terminal | Users** section), a security challenge is presented when attempting to access and modify setup selections (Figure 2-1).



**Figure 2-1: Security Challenge – Notification of Invalid Rights**

To save time when security is enabled, the first thing a user should do when entering setup to view or make modifications to configuration is navigate to the **Login** branch at the very top of the setup menu tree and enter a valid username/password combination.

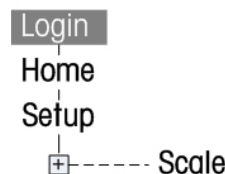

**Figure 2-2: Login Branch in Setup Menu Tree**

The user can enter any username/password stored in the User table. Successful entry will grant security access at the level associated with the entered account. While in setup, a user can move to a higher level of security clearance by entering a new username/password associated with a higher security clearance level at the Login branch. The security login expires upon exit of setup.

Outside setup, a similar security challenge may be presented to the user when attempting to access select operations via softkeys on the home page and runtime screens (Figure 2-3). Users are first notified that a security login is required. They are then taken directly to a login screen. The user can enter any username/password stored in the User table. Successful entry will grant security access at the level associated with the entered user account.

The security login expires upon exit of the selected operation.



**Figure 2-3: Operation Access Security Notification and Login**

### 2.2.2. Metrology Switch

If the metrology switch (SW1-1) is placed in the approved (ON) position, access to the Scale branch of setup and to other metrologically significant areas is not permitted. The metrology switch can be used to prevent Administrator level users from accessing metrology features even if the region approval is "None".

Selecting a specific region approval and setting the Metrology switch to ON alters some scale functions:

- If the approval is **Canada**, the terminal's functions are changed as follows:
  1. The keyboard tare command carries out a rounded tare.
  2. The center of zero division is 0.2d. The default value for non-approved mode is 0.25d.
- If the approval is **OIML**, then the power up zero range is +/- 10% and pushbutton zero range is +/-2%. For non-approved mode, this range can be selected by the user.
- If the approval is **Argentina**, the terminal's functions are changed as follows:
  1. Access to the setup screens is prohibited while the metrology switch is engaged. If an attempt is made to access the setup menu, a message is displayed that says "Access denied. Scale is Approved."
  2. All shared data server write ability via COM1 (serial) and Ethernet is disabled. Information can still be read from shared data, but writing to shared data is not possible.
  3. The FTP server (both serial and Ethernet) can only read files from the terminal. It cannot write anything to the terminal. Shared data field nf0101 will automatically be set to 2.
  4. If SICS is selected as an assignment for a port, all SICS commands must be disabled. When a SICS command is received, an "EL" response is returned.
  5. A preset tare from the front panel, from the tare table, received serially (for example 1.00T via the CTPZ input assignment) or received from a PLC, can only be accepted if there is no



motion on the scale. If motion is detected, the terminal should wait for the programmed stability timeout period and, if the motion continues, discard the request. The preset tare feature will therefore operate just like the semi-automatic tare feature.

- If the approval is **Australia**, the terminal's functions are changed as follows:
  1. The Power-up Delay setting for analog scale types found at **Scale I Type** is not available.
- If the approval is **Korea**, the terminal's functions are changed as follows:
  1. The selection of non-SI units is not permitted. The only units available for selection are kilograms (**kg**), tons and **grams**.
- If the approval is **Thailand**, and the Application setting at **Scale I Type I Application** is **Vehicle**, the following changes are implemented in the terminal:
  1. Under Zero Blanking is disabled. The terminal will display negative weight values instead of underload symbols.
  2. Activation of the screen saver is disabled.
  3. COM1 serial port interface selection is restricted to RS-232.

Access to the metrology switch may be sealed in conformity with local regulations in "legal-for-trade" applications. Figure 2-4 shows the location of the metrology switch.

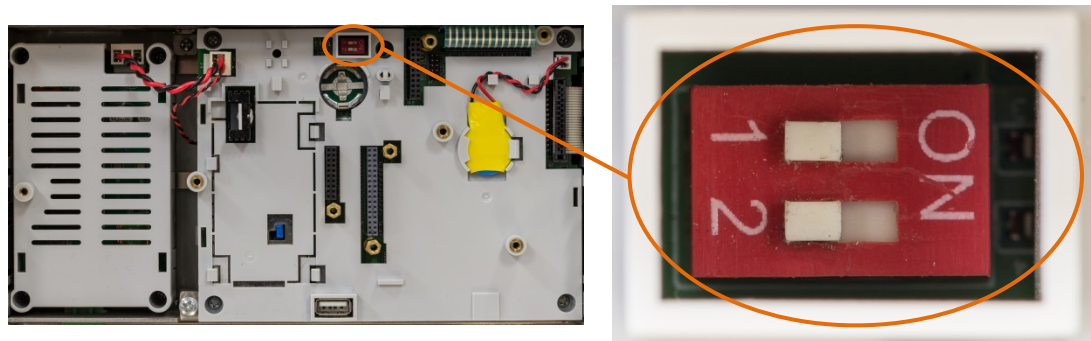

**Figure 2-4: Metrology Switch Location**

- Refer to the **PCB Switch Settings** section in the **IND570 Installation Manual**, for further information about SW1-1 and SW1-2 switch settings.

## 2.3. Terminal Operation

Key names and commands are identified in this manual by upper- and lower-case letters. Key names, such as ENTER, are in all upper-case letters, and commands, such as "select," are in lower-case (unless they begin a sentence, in which case the first initial is upper-case). For example:

"Press START..." means to press the START softkey .

"Select an option..." means to use the UP or DOWN navigation keys to highlight a setting, then press ENTER.

## 2.4. Understanding the HMI (Human Machine Interface)

Navigate within applications and configure the IND570 using:

- Navigation keys
- Scale function keys
- Softkeys
- Shared Numeric and Alpha keys

The locations of these keys and the display screen area are shown in Figure 2-5.



Figure 2-5: Key Locations and Display Screen

### 2.4.1. Navigation Keys

Navigation keys (see Figure 2-5) enable navigation within the setup menu tree, setup screens, and application screens.

#### 2.4.1.1. UP and DOWN Navigation Keys

These move the focus up or down to different setup options within the menu tree (focus is indicated by highlighted text), to different fields within a setup page, and to switch to another page of available softkeys. The UP and DOWN navigation keys are also used to move to a next or previous page when a scroll bar indicates that two or three pages are used for configuration fields associated with a specific parameter. The example in Figure 2-6 shows a configuration parameter that requires three pages to display all of the associated configuration fields. The scroll bars indicate which page of the three is displayed.



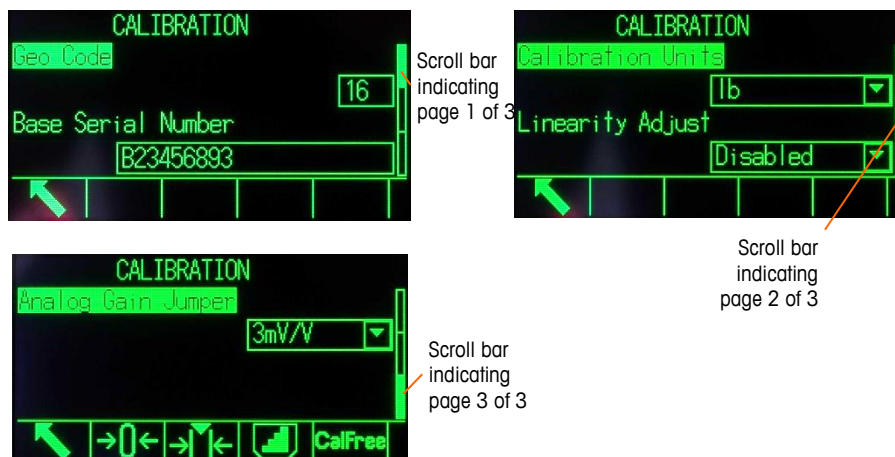

**Figure 2-6: Example of Scroll Bars, Indicating Three Pages of Configuration Fields**

Press the DOWN navigation key to move from page 1 to 2 or from page 2 to 3. Press the UP navigation key to move from page 3 to 2 or page 2 to 1.

#### 2.4.1.2. LEFT and RIGHT Navigation Keys

These keys are used to:

- Expand (RIGHT navigation key) the setup options in the menu tree
- Collapse (LEFT navigation key) the setup options in the menu tree
- Move the cursor position to a specific character in text areas
- Enable left and right scrolling to view all information available on a screen

#### 2.4.1.3. ENTER Key

The ENTER key is used to:

- Open the setup page for viewing and editing setup parameters
- Move the focus from a field label to a setup value for that field
- Accept new values entered in a field and move the focus to the next field label

#### 2.4.2. Softkeys and Icons























Five softkey buttons (Figure 2-5) are located along the bottom of the display screen. A graphic icon that identifies a softkey's function is displayed directly above each softkey. Five softkey identifiers or labels can be displayed at one time. IND570 supports up to a total of 15 possible softkey functions, displayed on three separate rows. A MORE DOWN symbol  displayed on the lower-right corner of the screen (to the far right of the softkey icons) indicates that more softkey selections are available. Press the DOWN navigation key to display additional softkey screens, and UP to display the previous softkey screen.

Chapter 3, **Configuration, Terminal I Softkeys** provides further detail on the configuration and customization of softkeys.



















Soffkeys and application displays use graphic icons for identification. Table 2-1 lists these icons and their functions, categorized according to their use/s within the HMI.

Refer to Appendix B, **Default Settings**, for additional details on the security levels for these soffkey associated functions.

**Table 2-1: Icons and Functions**

Icon	Function	Icon	Function
<b>Information Recall Options</b>			
	Recall information		Weight Recall
<b>M</b>	Metrology Recall		TaskExpert™ Checksum
<b>i</b>	System Information Recall		Print
	Service Information Recall		Terminal Status
	Load Cell Detail (POWERCELL version only)		Reset Counters (POWERCELL version only)
	Connected Devices Recall		Email
	Transmit Email		Bluetooth Information Recall
	WiFi Information Recall		
<b>Soffkey Menu and Setup</b>			
	Enter Setup Menu		More Soffkey Selections (scroll rows up and down)
<b>Calibration Icons</b>			
<b>Cal FREE</b>	CalFree™ Calibration		Capture Zero
	Capture Span		Step Calibration
<b>Srvc Mode</b>	Service Mode (access the IDNet service mode)		Start Calibration Test
	Run Calibration Test		Test Weight Information
	Skip (skips failed Calibration Test step and continues with the test)	<b>i</b>	Test Information

Icon	Function	Icon	Function
	Load cell address (POWERCELL version only)		
<b>GWP® Icons</b>			
<b>GWP</b>	GWP Test Access		Start (Any user is valid, but user name must be entered to initiate test)
	Test Weight Information	<b>i</b>	Test Information
	Skip (skips failed GWP Test step and continues with the test)	<b>C</b>	Clear Test Weights
<b>Table, Memory and Function Access</b>			
	Tare Memory (access the tare table)		Target Memory (access the target table)
<b>Alibi</b>	Alibi Memory		Active Target
	View Table (access a table to view or retrieve a record)		Search (begin the search of a table for a record or group of records)
<b>→T←</b>	Tare (captures live scale weight into the tare record – Tare Table edit only)		Comparators
	Reports (recall and print reports for Alibi Memory, Tare Table, or Target Table)	<b>C*</b>	Clear Tare and Target Table n & Totals
	Transaction Counter		Reset Counter
	Time & Date		Print
	Repeat Print		Customized Print Triggers 1, 2 and 3
	Totals Recall	<b>C</b>	Clear Subtotal
<b>C</b>	Clear All	<b>USB</b>	USB File Transfer (refer to section 0 for details on security surrounding USB file transfer)
<b>ID 1</b>	ID (initiates a programmed transactional sequence). ID1, ID2, ID3 and ID4 available.		POWERCELL Performance Log (Triggers a manual record: POWERCELL version only)
<b>Editing</b>			
<b>C</b>	Clear All		Exit (return to previous screen)

Icon	Function	Icon	Function
	Delete		Insert
	Edit		Validate Entry/Transaction (OK)
	Escape (exit without storing)		Copy
Display Icons			
<b>x10</b>	Times 10 Display (expands the displayed weight by 10)*	<b>Smart-Trac</b>	SmartTrac (turns SmartTrac display off and on)
<b>Min-Weigh</b>	MinWeigh		Unit Switching
	Backlight Adjustment		
Special Control			
	Target Control		Start
	Pause		Stop/Abort
	No	<b>C*</b>	Clear Total
	Reset		
Task Selection Icons (only used with TaskExpert™ is installed)			
	Task List – Displays list of assigned TaskExpert applications	 2	Task 2 – Starts TaskExpert application designated as Task 2
 1	Task 1 – Starts TaskExpert application designated as Task 1	 3	Task 3 – Starts TaskExpert application designated as Task 3

\* Note that for IDNet platforms in the approved mode, in order for the x10 function to operate properly, the Update Rate must be set at 20. Values of 5 or 10 for the update rate will result in longer display of the expanded weight value, which is not permitted.

### 2.4.3. Scale Function Keys

The scale function keys, indicated in Figure 2-5, are:



ZERO

When the scale platform or weighbridge is empty, the terminal should indicate zero. The gross zero reference is recorded during calibration. Press the ZERO scale function key to capture a new gross zero reference point if pushbutton zero is enabled in configuration and the weight is within the zero range.



TARE

Tare is the weight of an empty container. Tare is normally used to determine the net weight of the contents of a container. Press the TARE scale function key when an empty container is on the scale. The terminal then displays a zero net weight. As the container is loaded, the terminal then displays the net weight of the contents. Pushbutton tare must be enabled to use this key in this manner.

When the empty weight of the container is a known value, enter the tare weight using the numeric keys and then press the TARE scale function key. The terminal will display the net weight of the contents of the container. Keyboard tare must be enabled in order to use this key in this manner. If the secondary Tare display is enabled, the tare value and type of tare will show in the lower left of the display (Figure 2-5).



CLEAR

When in the net weight mode, press CLEAR to clear the current tare value; the display will revert to the gross weight value. CLEAR operates regardless of motion on the scale. Note that once the tare value has been cleared, it cannot be recalled. The complete tare process as described above must be performed.

When in alphanumeric entry mode, CLEAR functions like a backspace key. Position the cursor at the end of data to be deleted and press the CLEAR key. Press the CLEAR key once for each character to be deleted. When first entering a data entry box, the previous entry will be in focus. Pressing CLEAR at this point will clear the entire previous entry.



PRINT

Press the PRINT scale function key to initiate a demand output of an assigned print template. A serial, USB or Ethernet print connection must be configured to link a template to the selected serial, USB or Ethernet port. When a print command is issued, **Printing** appears in the system line for 3 seconds (Figure 2-14).

## 2.4.4. Alphanumeric Keys

When data entry is required, use the terminal's 12-key alphanumeric keypad (see Figure 2-7) to enter letters, numbers and special characters.

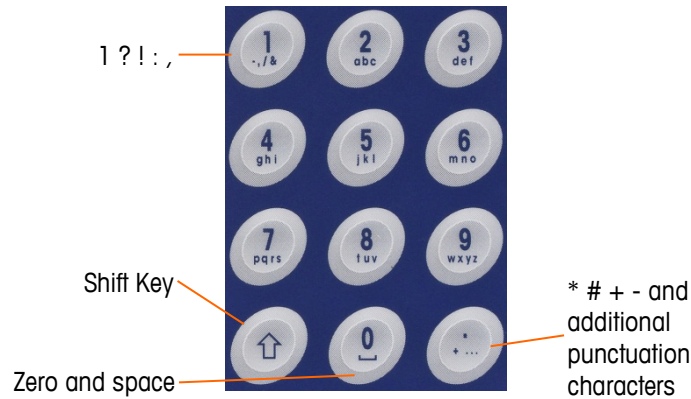

**Figure 2-7: Alphanumeric Keypad Layout**

Position the cursor in the field (see Navigation Keys) and press the alphanumeric keys to enter the appropriate data. Press the DECIMAL key to enter decimal points where necessary. A setup parameter, at **Terminal | Region | Language**, changes this decimal input to a comma.

During data entry, the CLEAR key functions like a backspace key (see Figure 2-5). Position the cursor at the end of data to be deleted and press the CLEAR key once for each character to be deleted. When a data entry box is first selected, the entire data string will be in focus. Pressing CLEAR at this point will clear the entire previous entry.

The ESCAPE **Esc** and EXIT  softkeys exit the data entry process without accepting any of the new data typed. Any data that was in the entry field before the new entry was initiated will remain there.

Once desired alphanumeric characters have been entered in appropriate fields on the screen, press the ENTER key to accept the entries.



## 2.5. Data Entry

When data entry is possible, an entry mode graphic will appear at the top right of the terminal display, as shown in Figure 2-8. The entry mode graphic represents one of several possible entry modes as listed in Table 2-2.



**Figure 2-8: Data Entry Mode Type**

**Table 2-2: Data Entry Modes**

Graphic	Entry Mode
123 	Numeric Entry
ABC 	Upper Case Alpha Entry
abc 	Lower Case Alpha Entry

The SHIFT key on the keypad (refer to Figure 2-7) is used to change between the available entry modes. The modes available depend on the type of entry field selected.



## 2.5.1. Data Entry Modes

### 2.5.1.1. Numeric Entry

123

In this mode, only the numeric value shown on the key pressed is entered. Multiple presses of the numeric key will result in multiple entries of the same number. The decimal point is also available.

### 2.5.1.2. Upper- and Lower-Case Alpha Entry

ABC, abc

In these modes, the first character shown under the large number on the key pressed is entered (either a capital or lower case letter, except for the "1" key and the "." key). Each key supports multiple characters. To enter the second character shown on the key, press the key a second time before the timeout period. To enter the third character shown on the key, press the key one more time before the timeout period. If the key is pressed again before the timeout, it will show the next character (for the "1" and "." keys) or wrap back around to the first character. The space key (located on the "0" number key) is also accessed in these modes.

When a language other than English is selected in terminal setup, various unique characters for the selected language will become available when their respective key is pressed.

## 2.5.2. Special Symbols and Punctuation Entry



Two of the keys provide access to punctuation and other special characters and symbols. Due to the number of characters associated with "." and "1" keys, these keys function differently than the other alphanumeric keys. When in the upper case ABC or lower case abc letter entry mode, pressing the "1" key or the "." key will generate a pop-up screen with the first character in focus (Figure 2-9, Figure 2-10, Table 2-3).



Figure 2-9: "." Key Characters



Figure 2-10: "1" Key Characters

Navigate (UP, DOWN, RIGHT, LEFT) until the desired character is in focus, and press ENTER.

Table 2-3 shows available symbols and special characters and their access key. If an incorrect character is entered, the CLEAR key will delete the character from the data entry box.

To exit without selecting a character, press the left softkey. The far left softkey functions as an ESCAPE (Esc) or EXIT ⏏ softkey key when no softkey is actually displayed.

Table 2-3: English & Global Special Symbols and Characters

Mode	Key	English & Global Keyboard Settings
ABC	1	? ! , ; ' " ( ) \ /   [ ] { } ¡ ¢ \$ € £ ¢ ¥
abc	.	* # + - ± × ÷ < = > @ & % ° « » μ © ® ^ _ ~ ² ³



### 2.5.3. Global Character Entry

If Keypad Selection (in setup at **Terminal | Region | Language**) is set to **Global**, all the international characters will be added to the end of the standard alpha character rotation for the associated key. For example, when **Global** is selected, all the international versions of the letter "e" that are supported in the ISO8859-15 character set are added to the end of the character selections on the "d e f" key after the letter "f". Table 2-4 shows which keys support which characters, and the sequence in which they appear.

- Note that no additional characters are associated with the "5" key.
- Russian Cyrillic characters are not supported through the shared alphanumeric keypad.

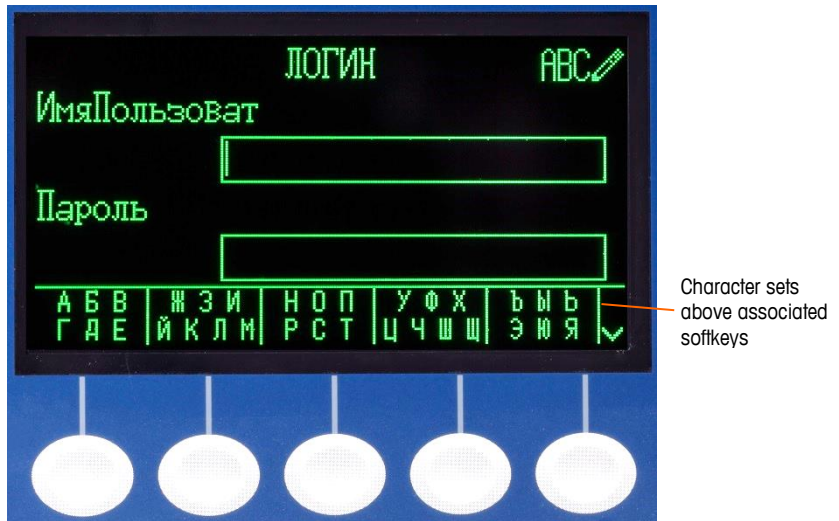

**Table 2-4: Global Characters**

Mode	Key	English	Global
ABC 	2	A B C	A B C Ä Å Æ Ç
	3	D E F	D E F È É Ê Ë
	4	G H I	G H I Ì Í Î Ï
	5	J K L	J K L
	6	M N O	M N O Ñ Ò Ó Ô Õ Ö Ø
	7	P Q R S	P Q R S Š
	8	T U V	T U V Ø Ù Ú Û Ü
	9	W X Y Z	W X Y Z Ý Ž
abc 	2	a b c	a b c à á â ã ä å æ ç
	3	d e f	d e f ð è é ê ë
	4	g h i	g h i ì í î ï
	5	j k l	j k l
	6	m n o	m n o ñ ò ó ô õ ö ø
	7	p q r s	p q r s Š š
	8	t u v	t u v ø ù ú û ü
	9	w x y z	w x y z ý ž

**2.5.3.1. Russian Characters**

The 12-key alphanumeric keypad cannot support Cyrillic characters of the Russian language. In this case, softkeys function as alpha keys (see Figure 2-11) that are used to enter these unique alphabetic characters. The softkeys that support Cyrillic characters are automatically displayed when focus is moved into a data entry box that supports alpha entry. Each softkey contains 1-7 Cyrillic characters (Figure 2-12).



**Figure 2-11: Cyrillic Characters via Softkeys**



**Figure 2-12: Additional Rows of Cyrillic Characters**

To enter a character, use the UP and DOWN arrow keys to move to the row of softkeys that shows the group including the desired character. The presence of the MORE UP / MORE DOWN symbols to the right of the softkeys indicates that additional sets of characters are available. Once the correct row is showing, press the softkey under the group of characters which includes the desired character.

At this point, the characters above the softkey will change to show one character per softkey (Figure 2-13).



**Figure 2-13: One Character Per Softkey**

Now, press the softkey that corresponds to the desired character. Also note that the MORE DOWN symbol is shown at the right of the softkeys. Press the DOWN navigation key to view the second row of characters. This group will include an ESCAPE softkey (Esc) (Figure 2-12). If the wrong group of characters was selected, use this softkey to return to the character set selection screen.

Repeat this process until all Cyrillic characters have been entered. The CLEAR key can be used to delete unwanted characters in the entry box. The ESCAPE softkey (Esc) on the symbol group of softkeys ends the data entry process without accepting any of the new data typed. Data in the entry field will revert to whatever was in the entry box before the new entry was initiated.

Once all desired characters have been entered in appropriate fields on the screen, press the ENTER key to accept the entries.

## 2.6. Home Screen

The Home screen is the only screen that provides operator access to the programmable softkeys. Figure 2-14 shows a sample screen with a message showing in the system line.



**Figure 2-14: Default Home Screen, System Line with Print Message Displayed**

The appearance of the Home Screen will vary depending on the terminals' configuration, but it can include\*:

<b>Metrology Line</b>	Displays capacity and increment settings and WiFi signal strength, if the WiFi option is installed
<b>System Line</b>	Displays system messages, application data and the service icon
<b>Weight and Application Area</b>	Displays weight, units, tare and other application-specific weighing data
<b>Service Icon</b>	Indicates that a service specific event has occurred in the terminal
<b>Softkey Icons</b>	Displays the icons for the active softkey functions. The appearance of a MORE DOWN symbol ∇ or a MORE UP symbol ▲ symbol indicates that more softkey selections are available

\* Not all possible Home screen functions and display items are listed.

## 2.7. Basic Functionality

This section provides information about the IND570 basic functionality. Additional areas of functionality specific to application software available for the IND570 are addressed in the specific application manuals. Basic functions addressed in this section include:

- Zero
- Expand by 10
- Remote Display
- Calibration & GWP Tests
- Time and Date
- SmartTrac™
- Table Searches
- Email
- Tare
- Print
- CalFree™
- Calibration Management
- ID
- Comparators
- Reports
- USB Host
- Unit Switching
- Totalization
- MinWeigh
- Test Manager GWP®
- Target Comparison
- Alibi Memory
- Information Recall

	 <b>WARNING</b>
	<b>THE USB INTERFACE IS NOT CERTIFIED FOR USE IN DIVISION 2 OR ZONE 2/22 HAZARDOUS AREAS. USE ONLY IN SAFE AREA.</b>

For details on activating some of the more complex functions of IND570, please refer to Chapter 3, **Configuration** and Chapter 4, **Applications**.

## **2.7.1. Zero**

The Zero function is used to set or reset the initial zero reference point of the IND570. There are three types of zero setting modes:

- Automatic Zero Maintenance
- Power-Up
- Pushbutton

### **2.7.1.1. Automatic Zero Maintenance**

Automatic Zero Maintenance (AZM) enables the IND570 to compensate for the buildup of small amounts of weight and track itself back to the center of zero. Within the AZM operating range (programmable from 0.00 to 10.00 divisions), when the terminal is in a no motion condition, it makes small adjustments to the current zero reading to drive the weight reading toward the true center-of-zero. When the weight is outside of the programmed AZM range, this feature is not functional.

### **2.7.1.2. Power-Up Zero**

Power-Up Zero enables the IND570 terminal to capture a new zero reference point after power is applied. If the terminal detects motion during a power-up zero capture function, it will continue to check for a no-motion condition until zero is captured.

Power-up zero can be disabled or enabled, and the acceptable range above and below calibrated zero configured. The range is programmable from 0% to 100% of capacity and can include a positive range and also a range below calibrated zero.

### **2.7.1.3. Pushbutton Zero**

The pushbutton (semi-automatic) zero function can be accomplished by:

- Pressing the ZERO →  ← scale function key
- Programming a discrete input for zero and then activating this discrete input
- PLC command to the IND570
- Serial command (SICS or CTPZ protocols)
- A custom application

The range for all types of semi-automatic zero is selectable (0% to 100%) plus or minus from either the calibrated zero point (if power-up zero is disabled) or from the initial zero setting point (if power-up zero is enabled).

Remote initiation of the semi-automatic Zero command is possible via a discrete input, an ASCII 'Z' command sent serially (CPTZ and SICS), a command initiated by the PLC interface, or from an application.

#### 2.7.1.4. Timed Zero

The Timed Zero function works to monitor the weighing system to ensure that the scale sees the center of zero at stability within a certain time. This function has been implemented to satisfy requirements of the MID R51 approval for automatic catch weighing equipment.

The timed zero function is a combination of internal timer, display messages and a discrete output alarm. Once timed zero is enabled, an internal timer is initialized. If the scale sees the center of zero with no motion, the timer resets and the sequence begins again. If the scale does not see zero before the timer expires, the IND570 will turn on the "Zero Requested" discrete output and displays a "Zero Required" message in the system line.

After this, the timing sequence begins again. If the scale sees the center of zero with no motion, the discrete output is turned OFF, the timer resets and the sequence starts over again. If the timeout expires first, the IND570 will turn OFF the "Zero Requested" discrete output for 200ms then turn it back ON and display the "Zero Required" message again in the system line.

After this, the timing sequence begins again. If the timer expires a third time without resetting, the IND570 will:

- Turn OFF the "Zero Requested" discrete output for 200ms then turn it back ON
- Display the "Zero Required" message again in the system line
- Show dashes in the weight display to indicate invalid data
- Activate the System Error Alarm discrete output
- Set the Data Valid bit within the PLC cyclic data as invalid
- Change Status Word B of the Continuous Output data stream to indicate Zero Not Captured

At this point, the scale must see the center of zero at stability or it will remain disabled. After seeing center of zero at stability (a ZERO command may be required), all data outputs will return to valid status, the weight display will reappear, the Zero Requested discrete output will turn OFF and the System Error Alarm output will return to OFF status.

- It is recommended to leave Timed Zero disabled (its default setting) unless the application/installation requires MID R51 approval.

#### 2.7.2. Tare

Tare is the weight of an empty container. A tare value is subtracted from the gross weight measurement, providing a net weight (material without the container). The tare function can also be used to track the net amount of material being added to or removed from a vessel or container. In this second case, the weight of the material in the container is included with the tare weight of the

container as tare. The display then reflects the net amount being added to or removed from the vessel.

The IND570 display area can be configured in setup to display the active Tare value (see Figure 2-5 and Figure 2-14). Depending on the Tare type, the numeric Tare value may display with a T label or a PT label.

Tare types and associated operations available on the IND570 include Pushbutton Tare, Keyboard Tare (Preset Tare), Net Sign Correction, Auto Tare and Clear Tare.

### 2.7.2.1. Pushbutton Tare

Pushbutton tare can be configured in setup as enabled or disabled. When disabled, the TARE scale function key  cannot be used to obtain a tare.

If enabled, pressing the pushbutton TARE scale function key  initiates a semi-automatic tare. The IND570 will attempt to perform a tare process. If successful, the display changes to a zero net weight indication and the previous weight on the scale is stored as the tare value. The net mode will be indicated on the display. If the Tare display is enabled, the pushbutton tare value will be shown with a T label.

Several conditions could prevent the pushbutton tare function from working:

<b>Motion</b>	Pushbutton tare cannot be taken when the scale is in motion. If motion is detected when a pushbutton tare command is received, the IND570 will wait up to three seconds (default value) for a no-motion condition. If a stable (no-motion) weight condition occurs before the three second timeout (default value) expires, the pushbutton tare command is executed. If there is still motion at the end of timeout period, the command is aborted and a "Tare Failed–Motion" error displays.
<b>Pushbutton Tare Disabled</b>	If pushbutton tare is configured as disabled, the TARE scale function key will not initiate a semi-automatic tare.
<b>Negative Gross Weight</b>	Any pushbutton tare attempted when the gross weight is at or below zero is ignored and a "Tare Failed–Below Zero" error displays. Ensure that the gross weight is above zero for Tare to be possible.

### 2.7.2.2. Keyboard Tare

A keyboard tare, also called a preset tare, is a numeric tare value that is entered manually through the numeric keypad, received serially or via Ethernet from a peripheral device, or retrieved from the Tare Table memory. The preset tare value cannot exceed the capacity of the scale. A manually entered Tare value is interpreted to have the same units as the current displayed value. Motion does not impact the entry of preset tare values.

Keyboard tare can be configured in setup as enabled or disabled. When disabled, the numeric keypad and the TARE scale function key  cannot be used to obtain a tare.

To enter a preset tare value manually, use the numeric keypad or external to enter the tare value (data entered will display just above the softkeys with a "Data:" label) and press the TARE scale function key .

If configured in setup, remote equipment can enter a preset tare value using a serial command or PLC command (refer to Chapter 3, **Communication I Connections, Communication I PLC** and Appendix C, **Communications** for further information).

If the preset tare is successful, the display changes to a net weight indication, and the entered preset tare value is stored as the tare value in the active tare register. If Tare display is enabled, the pushbutton tare value will be shown with a PT label (Figure 2-5).

Several conditions could inhibit the preset tare function:

<b>Keyboard Tare Disabled</b>	If keyboard tare is disabled in setup, the numeric keypad and the TARE scale function key  cannot be used to obtain a tare.
<b>Over-Capacity or Under-Zero Conditions</b>	Preset tare is not allowed when the weight display indicates over capacity or under zero conditions. Any preset tare attempted when the scale is over capacity is ignored and a "Tare Failed–Over Capacity" error displays. Any preset tare attempted when the weight display indicates a blanked under zero condition is ignored and a "Tare Failed–Below Zero" error displays.

Preset tare can be entered in free format. If the entered value does not match the displayed weight decimal point location or display interval, the entered tare value is rounded to the nearest display interval and the decimal point adjusted to match the gross weight. The rounding method is that 0.5 or more of a display interval (d) is increased to the next display interval and 0.49 or less of a display interval is decreased to the next lower display interval.

When entering a preset tare value less than 1.0, the operator can enter the data without the leading zero (left of the decimal point), but all subsequent display, storage, or printing of this value will include the leading zero. For example, a preset tare entry of .05 will display as 0.05.

If a preset tare has already been established and another preset tare is entered, the second preset tare replaces the previous value (it does not add to the previous value). The replacement tare can be larger or smaller than the original tare value.

### 2.7.2.3. Special Tare Operation in Multi-Interval Scale Applications

When the IND570 is configured for multi-interval operation (refer to section 3.5.1.2.2 in **Configuration**), the IND570 only permits a pushbutton tare to be taken in interval # 1. A preset tare, including the recall of a stored tare from the Tare Table (refer to section 2.7.2.4) must be a value in interval # 1 as well. If a tare is attempted with a weight value found in interval 2 or 3, a "Tare Failed – Over Range" error is given.

- Because of the way the IND570 manages the tare, it is required that the final weighing system has a label displayed that indicates the maximum tare value within the capacity of interval # 1:  $T = nnn$ , where nnn is the capacity of interval 1.

The requirements for this marking are as follows:

- Required only for OIML approved terminals that are programmed for multi-interval (not multiple range).
- The descriptive markings shall be indelible and of a size, shape and clarity allowing easy reading.

- It shall be located in a clearly visible place on a sticker fixed permanently to the instrument.
- In case the sticker is not destroyed when removed, a means of securing shall be provided, e.g. a control mark that can be applied.

#### 2.7.2.4. Tare Table

The IND570 terminal contains a tare table with 99 records for storing tare weights that can be quickly recalled by the operator, instead of manually entering them for each transaction. This is especially useful when certain tare values are used repeatedly.

A 20-character description can be included for each record. This description can be used to help distinguish one tare record from another. Each tare record in the tare table also contains a totalization field. When totalization is enabled for the tare table, each time a transaction is completed using a specific tare ID/record, either the gross or net weight value (as selected in setup) will be added to the record totalization field and the corresponding counter within the tare record will be incremented by one.

A printed report of the records and totalization in the Tare Table is available. Appendix B, **Table and Log File Structure** provides additional details about the tare table.

#### 2.7.2.5. Loading Records from the Tare Table





The TARE MEMORY softkey  can be used in two ways to activate records from the Tare Table.

##### Quick Access to Records

When the ID of the Tare Table record to be used is known, use the Quick Recall method. Enter the ID using the numeric keypad and then press the TARE MEMORY softkey  to load the record into the active Tare register/memory. If the record is available, the data is loaded. If the record is not found, an "ID not found" error displays.

##### List Selection

When the ID of the Tare Table record is unknown, use the List Selection method. To use the List Selection mode:

1. Press the TARE MEMORY softkey  without any preceding data entry. The Tare Search screen displays.
2. Enter any search restrictions required or leave selections as they are to retrieve all records.
3. Press the SEARCH softkey  to view the selected records in the table.
4. Use the UP and DOWN navigation keys to scroll through the list until the desired record is highlighted.
5. Press the OK softkey  to load the selected record from the list.
6. Press the ESCAPE softkey  to return to the weighing operation screen without loading the record.

#### 2.7.2.6. Net Sign Correction

Net sign correction enables the terminal to be used for both shipping (inbound empty) and receiving (inbound loaded) operations. Net sign correction can be either disabled or enabled on the



IND570. Refer to the **Tare Types** section, in Chapter 3, **Configuration**, for further information about disabling and enabling net sign correction.

If net sign correction is disabled in setup, any stored weight value in the tare register is assumed to be a tare regardless of the gross weight present on the scale at the time of the final transaction and net values can be negative.

If net sign correction is enabled, the terminal will switch the gross weight and tare weight fields when necessary, so that the larger weight is the gross weight, the smaller weight is the tare weight, and the difference is always a positive net weight. Net sign correction affects the display, stored data, weight recall, and printed data.

Net sign correction will operate with pushbutton tare, preset tare, or stored tare records. An example of weight values with and without net sign correction is shown in Table 2-5. In this example, the tare register value is 53 kg and the live weight on the scale is 16 kg.

**Table 2-5: Weight Values With and Without Net Sign Correction**

Printed and Displayed	Net Sign Correction	
	Disabled	Enabled
Gross	16 kg	53 kg
Tare	53 kg	16 kg
Net	-37 kg	37 kg

- When net sign correction is enabled, the tare weight field on the home screen and the weight recall screen will be labeled with the letter “M” to indicate “Memory” instead of “T” or “PT” (Figure 2-15).



**Figure 2-15: Tare Displays with Net Sign Correction Enabled**

**2.7.2.7.**

**Auto Tare**

The IND570 can be configured so that tare is automatically taken (auto tare) after the weight on the scale exceeds a programmed tare threshold weight. Auto tare can be configured in setup as enabled or disabled. When auto tare is enabled, the display changes to a zero net weight indication after the weight exceeds the threshold value. The previous weight on the scale is stored in the tare register as the tare value. Auto tare operations involve:

**Tare Threshold Weight**      When weight on the scale platform exceeds the tare threshold value, the terminal automatically tares.

<b>Reset Threshold Weight</b>	The reset threshold weight must be less than the tare threshold weight. When the weight on the scale platform falls below the reset threshold value, such as when a load has been removed, the terminal automatically resets the auto tare trigger.
<b>Motion Check</b>	A motion check is provided to control the re-arming of the auto tare function. If disabled, the auto tare trigger will be reset as soon as the weight falls below the reset value. If enabled, the weight must settle to no-motion below the reset threshold before the next auto tare can be initiated.

Several conditions could prevent the auto tare function from working:

<b>Motion</b>	Auto tare cannot be taken when the scale is in motion. If motion is detected after the weight on the scale exceeds a preset tare threshold weight, the IND570 will wait for a no-motion condition. If a stable (no motion) weight condition occurs within three seconds, the auto tare command is executed.
<b>Auto Tare Disabled</b>	Auto tare can be configured in setup as enabled or disabled.

### 2.7.2.8. Clearing Tare

Tare values can be cleared manually or automatically.



#### 2.7.2.8.1. Manual Clear

Manually clear tare values by pressing the CLEAR function key  when the IND570 is in the net mode and has completed the weighing operation. Motion on the scale will not impact a manual clear.

#### 2.7.2.8.2. Auto Clear

The IND570 can be configured to clear tare automatically when the weight returns to a value below a programmable threshold, or when a print command is issued. Once the tare is cleared, the display returns to the gross weighing mode.

Auto clear is disabled or enabled in setup. If auto clear is enabled the following parameters, configured in setup, affect the auto clear operation:

<b>Clear Threshold Weight</b>	The clear threshold weight is the gross weight value below which the IND570 will automatically clear a tare after settling to a value above this threshold value.
<b>Motion Check</b>	A motion check is provided to control the automatic clearing of tare. If the motion check is disabled, the tare value is cleared as soon as the weight drops below the threshold weight (auto clear threshold), regardless of the motion status. If the motion check is enabled, after meeting the requirements for weight value above and then below the threshold weight (auto clear threshold), the IND570 waits for a no motion condition before automatically clearing the tare.
<b>Clear After Print</b>	If enabled, tare is automatically cleared and the scale returned to the gross mode after data has been transmitted by pressing the PRINT scale function key  or from a remote source.
<b>Clear With Zero</b>	If enabled, pressing the ZERO scale function key  will first clear the tare

then issue a zero command.

Refer to the **Scale | Tare | Auto Clear** section of Chapter 3, **Configuration** for further information about configuring auto clear.

### 2.7.3. Printing

The print function (demand output) can be initiated by:

- Pressing the PRINT  function key
- Pressing a custom print trigger softkeys
- Through the automatic print function.

Demand output of data may also be initiated as part of a particular sequence of operation or special application software.

A **Printing** system message (visible in Figure 2-14) appears for 3 seconds when the terminal is carrying out a demand output command.

#### 2.7.3.1. Enabling Printing

To execute a print successfully, a serial, USB or Ethernet connection must be configured with a Demand Output assignment and linked to a template and trigger associated with the selected serial, USB or Ethernet port. If a print command fails because a Demand Output assignment is not programmed on any port, the synchronous error message "Print Failed-No Demand Output" is displayed.

#### 2.7.3.2. Print Interlock

Print Interlock is designed to enforce a single demand output per transaction. Print Interlock can be disabled or enabled. If enabled, the print command is ignored until the measured gross weight exceeds the print interlock threshold. After the first print command is executed, subsequent print commands are ignored until the gross weight indication falls below the print interlock reset threshold. If a print command is blocked by print Interlock, a synchronous "Print Not Ready" error is generated.

#### 2.7.3.3. Automatic Print

Automatic initiation of a demand output occurs after the gross weight exceeds the minimum threshold and there is no motion on the scale. After initiation, the gross weight must return below the reset threshold before the next automatic print can occur.

Automatic print may be disabled or enabled. Automatic print can be triggered and reset by weight exceeding set thresholds or by weight deviation from a previously stable reading.



#### 2.7.3.4. Repeat Print

The Repeat Print softkey  permits the data output of the most recent demand output to be printed again with a DUPLICATE header or footer to distinguish it from the original print.

To enable the Repeat Print function, simply add the Repeat Print softkey  to the Home Page. Pressing this softkey will initiate a repeat print of the last Demand Output connection listed in the assignments found in Setup at **Communication I Connections**.

The repeat output template can be flagged with a "DUPLICATE" header or footer to indicate that the data in the output template was generated as a repeat of a previous communication.

#### **2.7.3.5. Custom Print Trigger**

The three custom print triggers    available in the IND570 can be used to print specific output templates when activated. These custom print triggers will NOT trigger Alibi logging, totalization or transaction counter update. It is recommended that custom print triggers only be used to transmit output templates that do not contain metrologically sensitive data (weight data). However, the user is not blocked from doing so.

#### **2.7.3.6. Report Printing**

To print any of the IND570's standard reports, either through the REPORTS  softkey or from within an application, a serial, USB or Ethernet connection must be configured with a Report assignment. If a report print fails because a Reports assignment is not programmed on any port, the synchronous error message "No Reports Connection" is displayed.

### **2.7.4. Totalization**

It is frequently useful for the user of weighing equipment to know how many weighing transactions have been processed and how much material was processed during a particular period of time. Often there is also a need to subdivide this information according to material or item number, customer account, etc. The IND570 supports several methods for tracking the number of transactions and processed material. Totalization can occur in the general scale totals register, within the Tare Table and within the Target Table. Refer to **Application I Operation I Totalization** in Chapter 3, **Configuration** for more details on totalization within the Tare Table and Target Table.

#### **2.7.4.1. Transaction Counter**





A Transaction Counter tracks the total number of transactions processed by the IND570. A transaction occurs when the scale PRINT function is executed directly from the front panel or any of the available remote means (discrete input, PLC or SICS command, etc.) The custom print triggers or duplicate prints do not impact the Transaction Counter.

The Transaction Counter softkey  can be programmed on the home screen. If Counter Reset is enabled, the transaction counter can be reset to zero through this softkey. The next value for Transaction Counter can be also be cleared or edited in the Terminal branch of setup.

#### **2.7.4.2. Grand Total and Subtotal**

The IND570 terminal provides totalization in both grand total (GT) and subtotal (ST) registers. The total amount of weight processed each time a transaction has completed (PRINT function has been executed) is accumulated in these registers. Each register also has a unique transaction counter. The counters record the number of transactions that have been totalized/accumulated in each register.



### 2.7.4.3. Totals Recall

The Totals Recall softkey , available for assignment to the home screen, displays the sub-total and grand-total transaction counters and total weight for the terminal. Press the CLEAR SUBTOTAL softkey  to clear the sub-total amounts. Press the CLEAR softkey  to clear both the grand-total and sub-total amounts. Press the PRINT softkey  to print a report of the totals.

- If either **Clear Total** or **Clear Subtotal After Print** is enabled in setup, these values will clear after printing. If security is enabled, Supervisor level log-in or higher to execute this PRINT.

### 2.7.5. Unit Switching

In order to support locations and applications that utilize multiple measurement units, the IND570 supports unit switching. The UNIT SWITCHING softkey  enables switching between primary units (the main unit of measure) and alternate units (second or third units).

When the UNIT SWITCHING softkey  is pressed, the display changes from the primary unit to the secondary unit. When this softkey is pressed again the display switches to the third unit (if one has been programmed), or returns to the primary unit. Each subsequent time the UNIT SWITCHING softkey  is pressed the IND570 continues to switch the unit through the same sequence.

When units are switched, the units value changes to the correspondingly selected units, and the conversion of the display value occurs. The display division changes to an equivalent weight value in the switched unit (for example, from 0.02 lb to 0.01 kg) and the decimal location switches to accommodate the conversion.

When switching units, the capacity of the converted units is dictated by the original number of divisions established in the capacity and increments area of setup. In some situations, this may reduce the capacity of the terminal when converting to second or third units.

### 2.7.6. Expand By 10

The EXPAND BY 10 softkey **x10** is used to increase the selected weight display resolution by one additional digit. For example, a weight display of 40.96 could increase by one additional digit to display as 40.958. The Expand By Ten mode is indicated on the display by **x10**, which displays in the Legend area of the display (Figure 2-5). When the EXPAND BY TEN softkey **x10** is pressed again, the display reverts to the normal display of weight.

If the terminal is programmed as approved with the metrology switch (SW1-1) ON, the Expand By Ten mode is displayed for five seconds then automatically returns to normal resolution. Printing is disabled when the weight is expanded and the terminal is programmed as approved.

### 2.7.7. Loading Alert (PowerDeck platforms only)

For accurate weighing, loads should be placed so that their center of gravity is near the geometric center of the platform's load cell arrangement. This is particularly important in cases where the platform is flush with the floor, and it is possible for part of the load to overhand the platform and be supported by the floor, reducing the measured weight.

When a PowerDeck platform is connected to the IND570, an additional operational feature is available to assist a user in centering the load on the platform. Once enabled and configured in

Setup, whenever the center of gravity of the load is outside of the user configured "OK" Zone, a Loading Alert screen is shown.

The Loading Alert displays as a rectangle representing the scale base, keyed with load cell numbers 1 through 4. If an off-center condition is detected, a dot appears to indicate the quadrant experiencing the most extreme deviation. In this case, the operator should visibly inspect the load to make sure it is completely on the platform and if not, take steps to properly center the load or container for which a weight is to be captured.



**Figure 2-16: Terminal with PowerDeck Platform, Displaying Off-Center Load Indication**



**Figure 2-17: Loading Alert Display**

### **2.7.8. Remote Display**

When properly configured, the IND570 can function as a remote terminal for another IND570 terminal or for another METTLER TOLEDO product capable of transmitting METTLER TOLEDO Continuous Output (see Figure 2-18). If the remote IND570 will be used to issue simple C, T, P, Z commands to another terminal (referred to as the Primary terminal), the Primary must be able to accept Command Inputs (CPTZ). Remote Terminal communication in the IND570 is supported over WiFi, Ethernet and serial interfaces. Refer to Chapter 4, **Applications**, for details on configuring IND570 for use as a remote terminal.

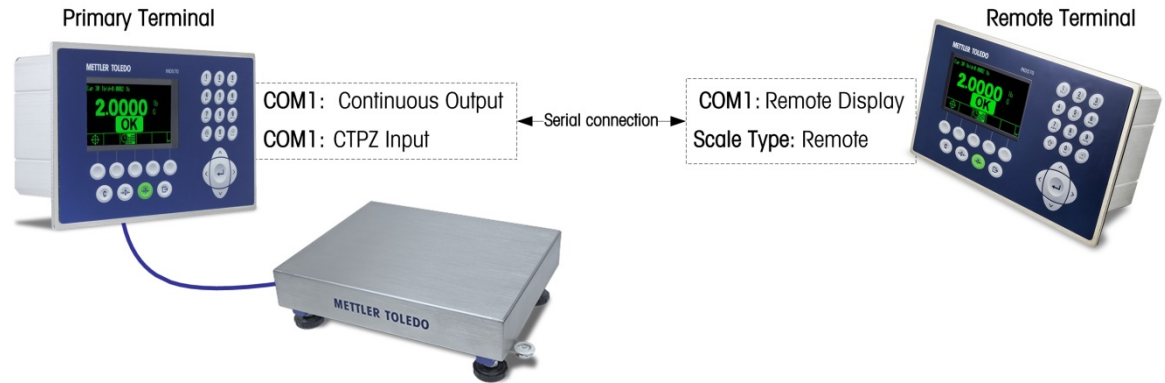

**Figure 2-18: Remote Display Function via Serial Communication**

### 2.7.9. External Keyboard Mapping

- For information about language-specific keyboard layouts, please refer to the **Available Communication Interfaces** section of Appendix D, **Communications**.

### 2.7.10. Calibration Management

Routine verification of a system's weighing accuracy is strongly recommended. IND570 provides a method to routinely schedule maintenance and testing to guarantee the continued accuracy of a weighing system over time. Calibration Management considers the usage pattern of the equipment to prompt for routine testing or to schedule a service call for certified system calibration testing, supporting proactive rather than reactive maintenance.

#### 2.7.10.1. Service and Testing Triggers

A weighing system degrades over time and wears with use. For systems with sporadic heavy use, the number of weighments should determine the test interval while a system that is either lightly used or used in a highly regular fashion might benefit from a time interval as the test trigger.

The IND570 offers both an elapsed time interval trigger and a weighment counter trigger for scale calibration. The exact amount of time or number of weighments between service testing depends on the site specific circumstances, customer expectations, and perhaps on local legal metrology requirements.

#### 2.7.10.2. Service and Testing Notification

Notification to the user occurs once a calibration service interval has been exceeded. IND570 supports a variety of notification schemes, including:

- System line messages on the terminal display
- Disabling of the scale
- Service Icon indicator on terminal display
- Email alerts

The method of clearing or resetting the notification depends on the type of notification. Additional details regarding the setup of Calibration Management, including triggers and notifications can be





found in the **Maintenance | Configure/View | Calibration Management** section of Chapter 3, **Configuration**.

### **2.7.10.3. Calibration Test**

IND570 provides a programmable Calibration Test sequence designed to lead the tester through a set of predetermined steps that will compare the current terminal calibration with known test weights. A full description of the default calibration test along with modification instructions can be found in **Maintenance | Configure/View | Calibration Test** section of Chapter 3, **Configuration**.

#### **2.7.10.3.1. Performing a Calibration Test**

The test is accessed by pressing the CALIBRATION TEST softkey  ↓ on the home page. A screen appears, in which the name of the tester must be recorded. Depending on setup selections, the serial number and capacity of each of the test weights to be used in the test can be entered manually or confirmed against pre-entered information. This provides a traceable record for the calibration test.

The calibration test is started by pressing the START softkey . A display is shown that provides the active scale weight, the target and tolerance weight values, and two lines of instructions (as to where to place the weights). When the tester completes these instructions, he or she presses the OK softkey  and the terminal compares the actual weight on the scale to the programmed target weight for this step. If the comparison passes, the test continues to the next step. If it fails, a message displays that indicates a failure. After acknowledging the error, the tester can abort the test, retest the failed step, or skip the failed step.

At the end of the complete test, a test report can be printed that contains all the data of the calibration test. If the GWP Log is enabled (refer to the **Maintenance** section in Chapter 3, **Configuration**), a calibration test pass/fail result is recorded, providing a data record that can be utilized in compliance efforts. If the Maintenance Log is enabled, additional details on the calibration test are also recorded there.

### **2.7.11. Test Manager GWP®**

GWP (Good Weighing Practice) is a science-based global standard for efficient lifecycle management of weighing systems comprised of five important stages of a weighing instrument's lifecycle: evaluation, selection, installation, calibration and routine operation. GWP Verification is a service product offered by METTLER TOLEDO to help customers realize the full potential of their weighing systems.

The IND570 integrates GWP Verification with the embedded Test Manager GWP. This is a way to store and routinely execute testing procedures recommended by the GWP Verification service. Test Manager GWP considers the usage pattern of the equipment and prompts either for routine testing, or to schedule a service call for certified testing or system adjustment. This supports proactive rather than reactive maintenance.

#### **2.7.11.1. Routine Testing Triggers**

A weighing system wears with use and its performance may degrade over time therefore it is necessary to confirm that the performance still meets the customer's process requirements. For systems in heavy use, the number of weighing cycles should be used to determine the test interval;



in contrast, a system that is either lightly, or routinely used, a time interval should be used as the test trigger.

The IND570 offers both a weight cycle counter, and an elapsed time interval trigger for each individual GWP test.

The IND570 offers both an elapsed time interval trigger and a weighment counter trigger for each individual GWP test. The exact amount of time or number of weighments between routine testing depends on the site-specific circumstances and customer expectations, and may also be affected by local legal metrology requirements. In the case of GWP testing, the testing interval is determined as a part of the GWP Verification service.

### 2.7.11.2. Routine Testing Notification

Notification to the user occurs once a GWP test interval has been exceeded. IND570 supports a variety of notification schemes, including:

- System line messages
- Disabling the scale
- Service Icon indicator on the terminal's display
- Email alerts



The method used to clear or reset the notification depends on the type of notification. Additional details regarding Test Manager GWP setup, including triggers and notifications, can be found in the **Maintenance | Configure/View | GWP Management** section of Chapter 3, **Configuration**.

### 2.7.11.3. GWP Tests

IND570 provides three default GWP tests – one each for Sensitivity, Eccentricity and Repeatability. These default tests are based on GWP standard test procedures and are designed to lead the tester through a set of predetermined steps that will compare current terminal performance against known test weights and acceptable performance tolerances. Full descriptions of the default GWP tests and instruction on modifying these tests can be found in the **Maintenance | Configure/View | GWP Tests** section of Chapter 3, **Configuration**.

#### 2.7.11.3.1. Performing a GWP Test

GWP Sensitivity, Eccentricity and Repeatability tests are accessed by pressing the GWP softkey **GWP** on the home page. A screen will appear listing all enabled GWP tests. Tests can be selected and initiated from this screen. The tester's name must always be entered before a test can be initiated. Depending on setup selections, the serial number and capacity of each of the test weights to be used in the test can be entered manually or confirmed against pre-entered information. This provides a traceable record for each GWP test that is performed.

The selected GWP test is started by pressing the START softkey . A display is shown that provides the active scale weight, the weight target and control limits (test tolerances) values, and two lines of instructions. Additional information regarding the selected test can be viewed by pressing the INFORMATION **i** softkey. As the tester completes each step in the programmed instructions, he or she presses the OK softkey  and the terminal compares the actual weight on the scale to the programmed target weight and control limit for this step. If the comparison passes, the test continues to the next step. If it fails, a message displays that indicates a failure. After

acknowledging the error, the tester can abort the test, retest this step, or skip this step knowing that it failed.

At the end of the complete test, a test report can be printed that contains all the in-process data associated with the GWP test. If the GWP Log is enabled (refer to section 3.9.1.4., **GWP Log**, in Chapter 3, **Configuration**), a record of the GWP test final result is recorded in the log. If the Maintenance Log is enabled, additional details on the GWP test are also recorded there. These logs can serve to support compliance efforts.

### 2.7.12. **MinWeigh**

MinWeigh is a METTLER TOLEDO brand for Minimum Weight. The IND570 allow you to set a minimum weight threshold value whereby the terminal will evaluate if the object is too small to be accurately weighed based on the performance of the scale and the customer's process tolerance. In other words, the operator should ideally choose a scale with a lower capacity and a weighing range that more closely matches the accuracy requirements.

In many regions of the world, the minimum weight value is specified by regulations; however a GWP recommendation will determine this value based on the customer's process weighing requirements because in many cases this the minimum weight value may be higher than the minimum value specified by legal authorities, based on the process accuracy required by the customer. A GWP Verification is used to confirm this value.

When the MinWeigh function is enabled, the MINWEIGH softkey <sup>Min-</sup>Weigh on the home screen can be pressed to initiate the normal operation of the MinWeigh function. The MinWeigh function compares the current net weight with the programmed MinWeigh value. If the current net weight is greater than or equal to MinWeigh, all equipment functions behave normally. If the absolute value of the net weight is less than MinWeigh, the weight display includes a flashing MinWeigh symbol  to the left of the weight. If the user attempts to record the weight while in this condition, the printout will include an asterisk (\*) to indicate that the transmitted weight is not valid.

For specific step-by-step instructions on how to set up MinWeigh, refer to the **Scale I MinWeigh** section in Chapter 3, **Configuration**.

### 2.7.13. **CalFree™**

The IND570 terminal provides a method to calibrate a scale without using test weights. This is based on manual entry of capacity and performance data from the load cell or load cell platform. This method of calibration can be used for initial check-out and testing of systems or when a large structure is used as the weighing vessel and it is not possible to apply test weights to the structure.

- METTLER TOLEDO strongly recommends that test weights be used whenever possible as this provides the most accurate method of calibration and adjustment. Contact your local METTLER TOLEDO authorized service provider for more information on calibration of IND570.

### 2.7.14. **Time and Date**

Time and date are used for reporting, error and transaction log timestamps, and triggering service events. The TIME & DATE softkey  enables access to the Set Time & Date screen, where the user can set the time and date, including the hours, minutes, day, month, and year. When the time is set, seconds are set to 0.

Although the format for the time and date can be selected according to local preferences, the use of a timestamp in log files is not selectable. Timestamp formats are always fixed as:

**Date:** YYYY/MM/DD (for example, July 20, 2016 becomes the fixed format date 2016/07/20)

**Time:** HH:MM:SS stored in 24 hour format (for example, 10:01:22 PM becomes the fixed format time 22:01:22)

### 2.7.15. ID



The ID function provides a way to collect specific transaction information during a weighing application. Information such as operator, material, purchase order, batch number and similar data can be manually entered through the terminal's alphanumeric keypad, an external keyboard or a barcode scanner. The ID function can also be used to ensure that a specific sequence of operation is carried out the same way every time.

The IND570 provides four different ID sequences: ID1, ID2, ID3 and ID4. As many as 30 steps can be programmed in each ID. Some step assignments set up an on-screen message to the user to perform a particular action. Other step assignments cause the terminal to automatically carry out a specific function, such as a Tare. ID assignments are shown below:

<b>Alphanumeric</b>	Allows user to enter freeform data
<b>Clear Tare</b>	Automatically clears any stored Tare value and returns the scale to gross mode
<b>Numeric</b>	Allows user to enter data in numeric format only
<b>Print</b>	Automatically initiates a print. A print connection must be configured in the terminal for the print to execute successfully.
<b>Selection List</b>	Allows the user to select an entry from a pre-programmed dropped down list created within the ID. Up to six selections can be programmed.
<b>Tare – Auto</b>	Automatically executes a Tare
<b>Tare – Preset</b>	Prompts the user to enter a Tare value. User is required to press ENTER to accept the Tare.

ID2, ID3 and ID4 can only be triggered manually by an individual softkey. ID1 can be triggered in one of two ways:

<b>Softkey (Manually)</b>	Using the ID1 softkey
<b>Automatically</b>	By threshold and reset weight readings from the scale

If ID1, ID2, ID3 or ID4 is triggered by softkey, it can be programmed to loop, repeating the sequence until either the EXIT softkey  is pressed or an ESC softkey  is pressed while an alphanumeric entry field is selected.

When ID1 is set to function automatically, the sequence starts when a weight is placed on the scale that exceeds a programmed threshold value. When all the steps have been performed and the

weight is removed, the reading from the scale falls below a reset value. At this point the terminal is ready to begin the next sequence associated with ID1.

For additional details on ID mode configuration, refer to section 3.6.2.4., **ID1, ID2, ID3 and ID4**, in Chapter 3, **Configuration**.

## 2.7.16. Target Comparison

Target comparison is used to compare either the gross or net weight on the scale to a predetermined target value. This feature can be useful in both automatic and manual processes. As an example, an automatic filling system could provide a Start signal to the IND570 and the IND570 could control the feeder system to manage the filling a container to a desired target weight.

An example of a manual process could be a checkweighing station where an operator is checking net weight of packages. The IND570 can use its target comparison feature to provide a graphic Over - OK - Under indication to help the operator determine if the weight of each package is acceptable or not compared to a programmed target weight.

Target (setpoint) comparison is most often used in two types of applications:

<b>Material Transfer</b>	Requires that a control device (external to the IND570) deactivate when a target value is achieved
<b>Over/Under</b>	Classify a load placed on the scale platform as above or below the target value or within the target tolerance range

For analog load cell scales, the IND570 target comparison rate (the rate at which the IND570 compares the live scale weight to the desired target value) is 50 comparisons per second. The target comparison rate for high precision IDNet bases depends on the weighing module in the base.



Refer to the **Application I Memory I Target Table** and **Application I Operation I Target** sections in Chapter 3, **Configuration** for further information about configuring parameters for target comparison operations. Chapter 4, **Applications**, provides additional step by step instructions for implementing and enhancing material transfer and simple, static checkweighing in IND570.





### 2.7.16.1. Material Transfer Applications

If the target comparison of the IND570 will be used to control the flow of material, the application can be classified as a Material Transfer application. These types of applications are usually automated, but can also be manual. A single or two-speed feeding system is used to either add weight to or remove weight from the scale. The terminal monitors the change in weight and compares it to a previously entered target and other control parameters.

The following definitions explain some terms used in Material Transfer applications:



<b>Material Transfer Mode</b>	The target comparison mode that provides control for delivering a measured amount of material from one container or vessel to another. The transfer can apply to material entering (filling or weigh-in) or leaving a container or vessel (dosing or weigh-out).
<b>Target</b>	The target is the weight value that is the end goal of the material transfer process. If a container should be filled with 10 kg of material, the target value is 10 kg.





<b>Tolerance</b>	<p>The weight range above and below the target value that will be acceptable as an “in tolerance” target comparison. The tolerance can either be entered as a weight deviation from the target or a percentage deviation from the target depending upon the setup selection.</p> <p>■ NOTE: When using the basic IND570 firmware in material transfer mode, there are no discrete outputs that will indicate an under- or over-tolerance status during a material transfer cycle. The available Over Zone and Under Zone discrete output assignments are only active when weighing in over/under mode.</p> <p>If a tolerance status discrete output is required for a material transfer application, the optional Fill-570 application software has an Out of Tolerance discrete output assignment available.</p>
<b>Spill</b>	<p>The amount of material that will be added (on a weigh-in) or removed (on a weigh-out) from the scale after the final feed is turned off. In a weigh-in process, this is the material in suspension that will still fall onto the scale after the feed output is turned off. IND570 subtracts the spill value from the target value to determine the feed output cutoff point.</p>
<b>Coincidence Outputs</b>	<p>A coincidence output is always active and does not require a start or stop signal. If the weight on the scale is below the target minus the spill value, the outputs are “on”. If the weight is above the target minus the spill value, the outputs are “off”. This type of output typically requires logic external to the IND570 to provide the required control for feeding systems.</p>
<b>Latched Outputs</b>	<p>Latched outputs turn off at the target weight minus the spill value and remain off (regardless of additional weight changes) until a “start” signal is received. Latched outputs do not usually require external logic to perform standard weigh-in or weigh-out sequences. IND570 can handle much of a weigh-in or weigh-out process when latched outputs are used.</p>
<b>Concurrent Outputs</b>	<p>This describes one mode of operation of the feed outputs in a 2-speed feeding system. If the output type is programmed as concurrent, the both the fast feed and feed outputs are active at the beginning of a target comparison, and will continue to operate until the weight reaches the target minus the spill value minus the fine feed value. At this point, the fast feed output will turn off and the feed output will remain on until the weight reaches the target minus spill value.</p>
<b>Independent Outputs</b>	<p>This describes one mode of operation of the feed output in a 2-speed feeding system. If the output type is programmed as independent, the feed output does not turn on until the fast feed output turns off. Only one feeder speed is active at a time. It is the opposite of concurrent outputs.</p>
<b>Fast Feed Output</b>	<p>This refers to the physical output assignment connection that is used for the faster feed in a 2-speed feeding system. This output is not used in a single speed feeding system.</p>
<b>Feed Output</b>	<p>This refers to the physical output connection that is used for the slower feed in a 2-speed feeding system. This is the only feed output used in a single speed feeding system.</p>
<b>Fine Feed</b>	<p>The value entered for the amount of material that will be fed in the slower rate of feed in a 2-speed feeding system. This value and the spill value are subtracted from the target to determine the point that the fast feed output turns off.</p>
<b>Start</b>	<p>When using latched targets, the default condition is with the latch set or in the “off” condition. To turn any outputs “on”, a start signal is required. This could be the START softkey , a discrete input programmed as Target Start/Resume, or via the TARGET CONTROL softkey .</p>

- Pause** A pause function is provided in target comparison control in case a target comparison must be temporarily paused. This can be done by pressing the PAUSE softkey  under the TARGET CONTROL softkey  or by triggering a discrete input programmed as Target Pause/Abort. When paused, power is removed from the Feed and Fast Feed (if used) discrete outputs. After a target comparison has been paused, the process can either be resumed or aborted.
- Resume** After a target comparison process has been paused, it may be resumed by pressing the RESUME softkey  or by triggering a discrete input programmed as Target Start/Resume. When a target comparison is resumed, it continues to use the original target values.
- Abort** After a target comparison process has been paused, it can be totally stopped by pressing the ABORT softkey  under the TARGET CONTROL softkey  or by triggering a Target Pause/Abort discrete input. If abort is selected, the target comparison process is aborted.

#### 2.7.16.1.1. Target Control

Two different levels of target control are provided by the terminal for the Material Transfer mode. Latching outputs must be enabled to utilize either type of automated control.

For simple applications or applications that are more automated and require minimal operator input, only the START softkey  is needed to begin the target comparison process. No other control is provided by the user. The comparison runs to completion then the latch sets the outputs as FALSE until the START softkey  is pressed the next time.

For those applications where more operator control is expected for an occasional pause or to abort a comparison process, the TARGET CONTROL softkey  is used. Pressing the TARGET CONTROL softkey provides a dedicated display for the target comparison with the comparison status and appropriate softkeys shown. Possible status modes are "Ready", "Running" or "Paused". The appropriate control softkeys include START , PAUSE  and ABORT . An example of each target control display is shown in Figure 2-19, Figure 2-20 and Figure 2-21.



**Figure 2-19: Example of Ready State in Target Control**



**Figure 2-20: Example of Running State in Target Control**



**Figure 2-21: Example of Paused State in Target Control**

**2.7.16.2. Over/Under Applications**

If the target comparison of the IND570 will be used to statically checkweigh the weight of an item or product, the application can be classified as an Over/Under application. These types of applications are usually manual processes but can also be automated. The SmartTrac display indicates the classification of the weight placed on the scale and discrete I/O can be used to trigger external equipment such as indication lights or reject switches. The terminal compares the current weight to a previously entered target with tolerance values or zone limits and indicates the results. The following definitions will explain some terms used in Over/Under applications:

- Over/Under Mode** The target comparison mode that provides three zone classifications for weight placed on the scale. The classification can be Under if the weight is below the target minus the -tolerance, OK if within the tolerance range or Over if the weight is above the target plus the +tolerance.
- Zones** The IND570 provides 3 different classifications or “zones” in the Over/Under mode. The zones are Under, OK and Over.
- Over Limit** If a tolerance mode of “Weight Value” is selected in setup, the IND570 does not require the entry of a target value. In this mode, only the upper and lower limits for the OK zone are entered. When programmed for this mode, the over limit value is the maximum weight that will be classified as OK. Any weight above than this value will be classified as Over.
- Under Limit** If a tolerance mode of “Weight Value” is selected in setup, the IND570 does not require the entry of a target value. In this mode, only the upper and lower limits for the OK zone are entered. When programmed for this mode, the under limit value is the minimum weight that will be classified as OK. Any weight below than this value will be classified as Under.



- Target** The target is the ideal weight value for the product being tested. If a container should weigh exactly 10 kg, the target value is 10 kg.
- Tolerance** The weight range above and below the target value that will be acceptable as "OK" in the target comparison. The tolerance can either be entered as a weight deviation from the target, a percentage deviation from the target or as absolute weight (zone edges) depending upon setup.

## 2.7.17. Target Entry



To enter target comparison parameters, either directly edit the active records or load them with data from a record in the Target Table.

### 2.7.17.1. Direct Editing of Active Records

To edit the active record directly:

1. Press the TARGET softkey . (Refer to section 3.7.6, **Softkeys**, of Chapter 3, **Configuration**, for information about how to setup softkey display.) The Active Values screen displays.
2. Use the UP and DOWN navigation keys to scroll through the fields available for editing.
3. Press the ENTER key to select a field to edit.
4. Depending whether the mode is material transfer or over/under, and the type of tolerance selected, the active target record will show different fields to edit. Use the navigation and alphanumeric keys to enter values for all of the fields as needed.

	Over/Under	
Material Transfer (Either Tolerance Type)	Weight Deviation or % of Target Tolerance Type	Weight Value Tolerance Type
Target	Target	Over Limit
Spill	+ Tolerance	Under Limit
Fine Feed	- Tolerance	
+ Tolerance		
- Tolerance		

5. Press the OK softkey  to accept the edits to the active record.
  6. Press the ESCAPE softkey  to return to the weighing operation screen without saving the active record edits.
- **NOTE:** Target units in the active record are limited to units selected as primary, secondary or third units. Refer to the **Scale | Capacity & Increment | Primary Units** and **Scale | Units** sections in Chapter 3, **Configuration** for details on unit selection.

### 2.7.17.2. Loading Records from the Target Table





The TARGET MEMORY softkey  can be used in two ways to load records from the Target Table.

- Quick Access to Records** Use the Quick Recall mode when the ID of the Target Table record to be loaded is known. Use the numeric keypad to enter the ID and then press the TARGET



MEMORY softkey  to load the record. If the record is available, the data is loaded. If the record is not found, an "ID not found" error displays.

**List Selection** Use the List Selection mode when the ID of the Target Table record is unknown. To use the List Selection mode:

1. Press the TARGET MEMORY softkey  without any preceding data entry. The Target Search screen displays.
2. Enter any search restrictions required or leave selections as they are to retrieve all records.
3. Press the SEARCH softkey  to view the selected records in the table.
4. Use the UP and DOWN navigation keys to scroll through the list until the desired record is highlighted.
5. Press the OK softkey  to load the selected record from the list.
6. Press the ESCAPE softkey  to return to the weighing operation screen without loading the record.

### 2.7.17.3. Target Units

If second and/or third units are established in the IND570, target records that utilize either second or third units can be retrieved from the Target Table into Active Target status. The IND570 will convert the retrieved record into active units when the record is recalled. Pressing the TARGET softkey  will show the original units as recalled from the Target Table.

If an attempt is made to retrieve a record from the Target Table that does not use primary, second or third units, a "Units Mis-match" error will display indicating that record recall was unsuccessful.

### 2.7.18. SmartTrac™

SmartTrac is a graphic visualization of the weight on the scale, either gross or net weight. SmartTrac on the IND570 uses a bar graph visualization type for Material Transfer mode and a three-zone graphic for Over/Under mode.

Regardless of the weighing mode, there are three different sizes of SmartTrac that can be selected.

**2.7.18.1. Material Transfer Mode**

The material transfer SmartTrac display may be configured in setup as **Small**, **Medium** or **Large**. Each size provides different target and weight information on the display. Figure 2-22 shows the small size, Figure 2-23 shows the medium size, and Figure 2-24 shows the large size.



**Figure 2-22: Material Transfer SmartTrac, Small**

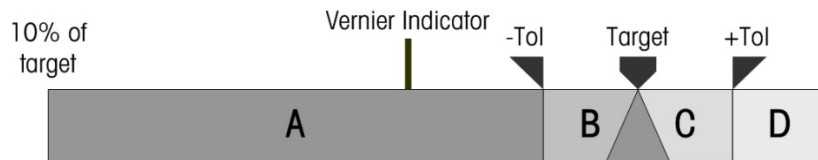

**Figure 2-23: Material Transfer SmartTrac, Medium**



**Figure 2-24: Material Transfer SmartTrac, Large**

While the bar graph display appears to be one continuous display, it can actually be broken into four separate zones. Figure 2-25 illustrates these.



**Figure 2-25: SmartTrac Bar Graph Display Zones**

## 2.7.18.1.1. Under Tolerance



The Under Tolerance Zone (A) represents the amount of material from 10% of the target value to the target minus the negative tolerance value. The bar graph begins to fill the A zone when more than 10% of the target has been added. Until the weight on the scale reaches the 10% point, no fill is shown.

## 2.7.18.1.2. Acceptable Under Tolerance



Zone B represents the zone of acceptable tolerance below the target value.

## 2.7.18.1.3. On Target



When the measured value exactly equals the target value an unfilled triangle indication displays.

## 2.7.18.1.4. Acceptable Over Tolerance



Zone C represents the zone of acceptable tolerance above the target value.

## 2.7.18.1.5. Over Tolerance

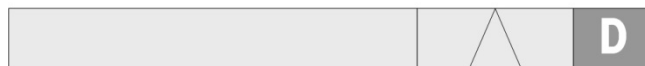

Zone D represents the zone of unacceptable tolerance above the target value. If the measured value is large enough that the number of display columns in the bar graph required for display exceeds the number available, the bar graph saturates and further increases in the measured value do not affect it.

- NOTE: When using the basic IND570 firmware in material transfer mode, there are no discrete outputs that will indicate an under- or over-tolerance status during a material transfer cycle. The available Over Zone and Under Zone discrete output assignments are only active when weighing in over/under mode.

If a tolerance status discrete output is required for a material transfer application, the optional Fill-570 application software has an Out of Tolerance discrete output assignment available.

## 2.7.18.1.6. Rate of Bar Graph Fill

In a material transfer operation, material is weighed into a vessel on the scale (or dosed out of a vessel on the scale) until the measured weight is within an acceptable tolerance limit. Typically, material is added quickly when the container is closer to empty and more slowly as the measured weight on the scale approaches the desired target value. This is especially true in manual filling and batching operations. To help maintain a good dynamic range in both regions (closer to zero

and near to target), the rate at which the material transfer SmartTrac fills in is different for the various sections of the bar graph.

In most material transfer applications, sections A and D will appear to fill in at much slower rate than sections B and C. This is because sections A and D usually represent a much larger weight range, where sections B and C typically represent only a few increments. The overall proportion of bar graph fill rate to weight gain is much higher in sections A and D.

When the bar graph fill reaches section B, the SmartTrac will appear to move very rapidly toward the target. This is an important concept to understand for proper operator training. The operator must understand that when SmartTrac is used during a manual filling process, the rate of material addition to the scale must slow down as the graph approaches section B, or the target and upper tolerance values will quickly be exceeded.

### Vernier

To further help an operator judge the final value more accurately during a manual fill, a vernier is present at the top of the material transfer SmartTrac. This vernier is a small, auxiliary display used with the main SmartTrac display to show the weight gain (or loss) in finer increments than the fixed SmartTrac. It appears as a vertical line at the top edge of bar graph (Figure 2-22, Figure 2-25), moving left to right. In section B, the vernier travels left to right at 1/3 of the rate of the bar graph, and its rate/weight proportion remains constant while it is displayed.

Testing has shown that if an operator refers to the vernier during a manual filling process, the opportunity to meet the target value within tolerances is much greater, since the main SmartTrac bar graph typically becomes more sensitive to the addition of weight when it is within the tolerance zone.

### 2.7.18.2. Over/Under Mode

There are three sizes of Over/Under SmartTrac selectable in setup. Each size provides different target and weight information on the display. Figure 2-26 shows the small size, Figure 2-27 shows the medium size, and Figure 2-28 shows the large size.

- Note that Figure 2-26 shows a composite display with **under**, **OK** and **over** graphics displayed simultaneously. This is not normal operation.



Figure 2-26: Over/Under Display, Small



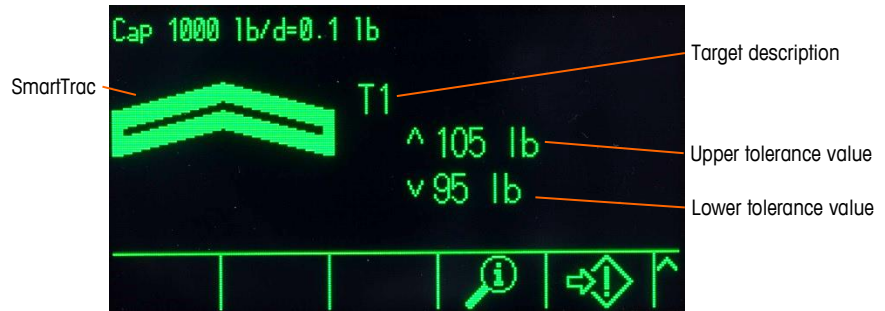

**Figure 2-27: Over/Under Display, Medium**



**Figure 2-28: Over/Under Display, Large**

- 2.7.18.2.1. Less than 10% of Target
 

Until the weight on the scale reaches 10% of the target value, the Under symbol is shown as a dashed line symbol (  or  ) and the discrete outputs are disabled. The Under zone symbol becomes solid and the discrete outputs become active when the weight on the scale is greater than 10% of the target weight.
- 2.7.18.2.2. Under Zone
 

The Under zone is shown at left in Figure 2-26, and in Figure 2-27. This zone classification is shown when the weight on the scale is greater than 10% of the target but less than the target value minus the -tolerance value (i.e., the highest value in section A of the graph, Figure 2-25). If a discrete output has been assigned to the Under Zone, this output will be “on” when the weight is in this zone.
- 2.7.18.2.3. OK Zone
 

When the weight on the scale is between the target minus the -tolerance and the target plus the +tolerance (i.e, within sections B and C, Figure 2-25), the OK symbol is shown. This symbol is the same for all sizes of SmartTrac. It is shown at center in Figure 2-26. If a discrete output has been assigned as Tolerance - OK, that output will be “on” when the weight is in this zone.
- 2.7.18.2.4. Over Zone
 

The Over zone is shown at right (section D) in Figure 2-26, and in Figure 2-28. This zone classification is shown when the weight on the scale is greater than the target value plus the +tolerance value. If a discrete output has been assigned as Over Zone, this output will be “on” when the weight is in this zone.

## 2.7.19. Comparators

The five Comparators in IND570 are simple, non-latching setpoints used to compare the active weight (or rate) value with to an absolute target (or rate) value or a defined weight range. The source for the comparison can be the Gross Weight, Displayed Weight, Absolute Displayed Weight, Rate, or Absolute Rate.

Comparators are controlled either by coincidence (either below or above an absolute target value) or by comparison with a range. The Active setting within Comparator setup determines the control mode in which a Comparator operates. When the Active setting is <, <=, =, >= or >, the selected source (weight or rate) is compared to a single target value. When the Active value is >\_ \_< (within a range) or \_<>\_ (outside a range), the selected source (weight or rate) is compared to a range defined by (low) Limit and High Limit values.

The COMPARATOR softkey  $\rightarrow| \leftarrow$  permits direct viewing of the Comparators from the home screen. This view screen displays each Comparator's ID, Description, Limit, Unit, High Limit (if applicable) and Active operator. Only the limit value/s can be edited via the COMPARATOR softkey. To edit parameters other than limits, the Comparator configuration screen must be accessed in setup.



Figure 2-29: Comparator Configuration Screens

To access a comparator's limit editing page directly from the home screen, press the COMPARATOR softkey  $\rightarrow| \leftarrow$ , use the UP/DOWN keys to select the desired Comparator from the list, and press the EDIT softkey  $\leftarrow| \leftarrow$ . If the ID of the Comparator is known, press the ID number of the Comparator, then the Comparator softkey. This will quick recall the specified comparator's limit editing page.

### 2.7.19.1. Comparators and Discrete Outputs

Comparators are intended to be used with discrete outputs. The function of a comparator is to trigger a discrete output based on the parameters of the comparator. Each comparator in the IND570 has an assignable discrete output that will activate when the comparator's settings are met. Refer to Chapter 4, **Applications**, for more information on the setup and use of comparators with discrete I/O.

### 2.7.19.2. Target Value Comparators

The assigned discrete output for a Target Value (coincidence) comparator will be triggered when the selected source is TRUE in regards to the selection in the comparator's Active setting.

## 2.7.19.2.1. Example

The Source is Rate. The Active operator is  $\leq$  (less than or equal to) and the Limit is 100 kg/min. The output will be ON when the rate is under 100 kg/min and will turn OFF when the measured value reaches 100 kg/min.

Refer to the section 3.5.7, **Rate** in Chapter 3, **Configuration** for more information on programming the Rate feature.

2.7.19.3. **Range Comparators**

In the case of a Range mode Comparator, the assigned output will be triggered when the selected source is TRUE in regards to the Active setting(s). The Limit setting establishes the lower of the two values that define the range. The High Limit setting defines the upper value of the range.

## 2.7.19.3.1. Example

The Source is Gross Weight. The Active operator is  $> \_ \_ <$  (within a range). The Limit is 300 kg and the High Limit is 800 kg. The output will be ON when the measured gross weight is between 300 and 800 kg. If the weight falls below 300 kg or exceeds 800 kg, the output will turn OFF.

## 2.7.19.3.2. Example





The Source is Gross Weight. The Active operator is  $\_ > \_ <$  (outside a range). The Limit is 200 lb and the High Limit is 400 lb. The output will be ON when the measured gross weight is 200 lbs or less and 400 lbs or higher. If the gross weight measures between 201 lb and 799 lb, the output will turn OFF.

2.7.20. **Alibi Memory Direct Access**

The Alibi Memory stores individual transaction data that can be retrieved for verification purposes. Information stored in the Alibi Memory includes:

- Transaction counter value
- Date and time of transaction
- Gross, net, and tare weights including units of measure



2.7.20.1. **Viewing and Printing Alibi Memory**

1. Press the Alibi softkey **Alibi** if programmed as one of the home position softkeys or press the REPORTS softkey  if programmed as one of the home position softkeys then select Alibi Memory from the selection box.
2. Press the VIEW TABLE softkey . The Alibi Search View screen displays.
3. Use the selection boxes and data entry fields to enter specific search information to limit the search, or do not enter any search limits to view all Alibi Memory Table information.
4. Press the START SEARCH softkey . The Alibi Search View screen displays the search results. Records are ordered by date and time with the most recent record shown last.
5. Press the PRINT softkey  on this screen to print the entire selected Alibi Memory Table.



Alibi Memory can also be exported from the terminal through the USB softkey. Refer to section 0 for additional details.



## 2.7.21. Table and Log Searches

A search function can be used to look up specific information in any of the IND570 tables and logs. This table search function can be accessed using various methods, including the TARE TABLE softkey , TARGET TABLE softkey , ALIBI softkey **Alibi**, REPORTS softkey , and from within setup.

### 2.7.21.1. Searching a Table or Log

1. Access the table to be viewed using the appropriate method. Refer to Appendix B, **Table and Log File Structure**, for more information about specific tables and log files.
2. Press the VIEW TABLE softkey . The Search View screen displays.
3. Use the selection and data entry boxes to enter specific search information to limit the search, or enter \* (the “wild-card” character) to view all table information.
4. Press the START SEARCH softkey . The Search View screen displays with the search results.

## 2.7.22. Reports

Several standard reports may be generated, viewed, and printed from database tables. Reports include:

- Alibi Memory
- Tare Table
- Target Table

The REPORTS softkey  must be displayed on the home screen in order to generate table reports. Otherwise, table reports can only be generated from within setup. In addition, a serial, Ethernet or USB port must be configured with its Assignment as Reports for report printing to be enabled.

### 2.7.22.1. Generating a Report





1. Press the REPORTS softkey . The Reports screen displays (Figure 2-30).



Figure 2-30: Reports Screen



2. Use the UP and DOWN navigation keys to select the desired type of database table report in the selection box.
3. The CLEAR TOTALS softkey **C\*** displays when the Tare Table or Target Table is selected. Press the CLEAR TOTALS softkey **C\*** to clear the totals in the selected table. A warning displays that requires verification that the user wants to clear the table totals.



4. Press the PRINT softkey  on this screen to print the entire selected report.
5. Press the EXIT softkey  to return to the home screen.
6. To select and print a sub-set of records from a table, press the VIEW TABLE softkey . The Search Screen for the selected report type displays (see Figure 2-31).



**Figure 2-31: Search Screen (Tare Table)**

7. Press the SEARCH softkey  to view all data in the table. Only fields enabled in setup display in tables.
8. To limit the data:
  - a. Use the Search Field selection box to select a desired search field (for example, search fields for the Tare table include Description, ID, n, Tare, and Total).
  - b. Use the Comparison selection box to select how the data will be limited (less than (<), less than or equal to (<=), equal to (=), greater than or equal to (>=), greater than (>), or not equal to (<>) are available in the selection box).
  - c. Use the numeric keypad to enter the limiting factor in the text box (the \* character is the "wild-card" character and returns all results).
  - d. Press the SEARCH softkey  to view the limited data in the table. Search result records are always listed in order by ID (lowest to highest ID numbers). Use the arrow keys to scroll left and right to view additional columns.
  - e. Figure 2-32 is an example of search results for a Tare Table, with two views showing all available columns of data.



**Figure 2-32: Tare Table Search Results**

### 2.7.23. SICSpro Cable-Free Floor Scale Sleep States

In order to extend battery life, when a Cable-Free Floor Scale (CFS) platform is not used for a period of time defined in the platform's Advanced Setup Mode (ASM), the Bluetooth module will enter a

sleep state, the platform will no longer transmit weight data to the terminal, and the terminal will display dashes in place of a weight. An alternating message will appear below the system line – “Platform is asleep” and “Add weight to wake up.”

To wake the scale, the platform must be given a sudden, firm jolt – simply placing weight on the scale is not sufficient. Once awake, the platform may require some time to start transmitting a stable weight. During this period, the terminal will display dashes instead of a weight, and the message “Scale is warming up” will appear below the system line. Once the scale is ready, the terminal will receive weight data and the home screen display will return to normal.

## 2.8. USB Host

IND570 provides a standard USB port classified as 2.0 Full Speed (12 Mbps/1.5 Mbps) host HID class and mass storage class. The USB port has an A type receptacle and provides +5V at a maximum of 500mA for connected devices.

	 <b>WARNING</b>
	<b>THE USB INTERFACE IS NOT CERTIFIED FOR USE IN DIVISION 2 OR ZONE 2/22 HAZARDOUS AREAS. USE ONLY IN SAFE AREA.</b>

- Only FAT and FAT32 USB flash drive formats are supported
- The maximum supported USB flash drive size is 32 GB
- Multiple devices can be connected simultaneously through an external USB hub
- Direct connection from IND570 to a printer or PC for data transfer is not supported.

The USB host port provides for the following functions:

- Connection to an external QWERTY keyboard, USB stick, bar code reader, or WiFi module
- Direct input of (barcode) scanned into various IND570 applications (e.g. ID fields). Refer to section D.1.3.1 for a list of barcode scanners which are known to be compatible
- Collection and storage of data for print templates and demand outputs
- File transfer between IND570 and a USB memory device
- Connection of a WiFi module for wireless network connectivity
- Flashing new firmware
- Backup and restore of terminal configuration and calibration
- Loading custom TaskExpert application files

### 2.8.1. USB Host Port – Default Settings

The USB Host port, standard on the IND570 mainboard, can be used for data input from an external keyboard or barcode scanner, or to transfer select files to and from the terminal. By default, the USB port is disabled. Access to the USB port must be enabled in setup before the IND570 will recognize the presence and type of connected USB device.

Press the ENTER SETUP softkey  $\blacktriangleleft$  and navigate to **Communication | Access/Security | USB** to enable use of the USB Host port. If user security is not yet enabled, no user login is required to enable the USB port. Once the port has been enabled, a USB device will be automatically recognized for use with the IND570 when it is connected.

### 2.8.2. USB Host Port Connection

When a mass storage device (a USB memory stick) is connected to IND570, the terminal automatically identifies the device type and determines that its purpose is data storage. The amount of time it takes for a memory device to be recognized depends on its size. The larger the memory, the longer recognition takes.

When an external keyboard or barcode scanner is connected to IND570, the user must identify its function  $\circ$ .



Figure 2-33: USB Device Identification Prompt

If the function is 'keyboard', the incoming data will be handled as an unbroken data string. If the function is not identified as 'keyboard', then the incoming data will be sent through the Input Template data parser where leading and trailing characters may be eliminated from the data string. When incoming data is sent to the data parser, it can also be assigned a specific function, for example selection of a table record ID. Refer to the **Communication | Templates | Input** section of Chapter 3, **Configuration**, for additional details on the Input Template data parser.

### 2.8.3. USB File Transfer

In order to improve ease and functionality when importing and exporting files to and from the terminal, a USB file transfer function can be accessed by pressing the USB softkey **USB**  $\circ$ .

When the softkey is pressed, the user is presented with a choice – either to write a file to a USB memory device, or to read a file from a USB memory device. Once the action is selected, the file type can be chosen. The file transfer is executed by pressing the START softkey  $\blacktriangleleft$ .

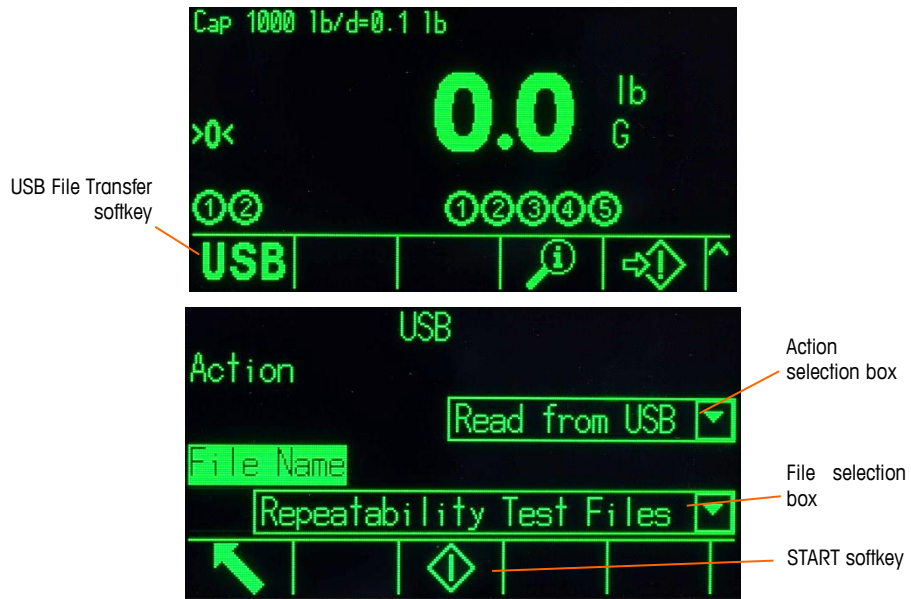

**Figure 2-34: USB File Transfer Function and File Selection Screens**

Table 2-6 lists the files that can be transferred using the USB softkey **USB**. The maximum file size that can be transferred via USB is 4 GB.

**Table 2-6: Files Available For Transfer via USB Softkey**

File Type	Export*	Import*	File Format
Action Log (only available with Fill-570 application software)	Yes	No	.csv
Alibi Memory	Yes	No	.csv
Calibration Test and Weight Information	Yes	Yes	.txt
Change Log	Yes	No	.csv
Error Log	Yes	No	.csv
GWP Log	Yes	No	.csv
GWP Tests with Weight Information	Yes	Yes	.txt
Terminal Status	Yes	No	.txt
Maintenance Log	Yes	No	.csv
POWERCELL Performance Log	Yes	No	.csv
Pac Statistics (only available when supporting application software is enabled in terminal)	Yes	No	.txt
Service Information Report	Yes	No	.txt
Tare Table	Yes	Yes	.csv
Target Table	Yes	Yes	.csv
Tables A0, A3 – A9	Yes	Yes	.csv

If the file already exists in the terminal (on an import) or on the USB memory device (on an export), a warning is displayed. The user must choose either to overwrite the existing file or to abort the process.

To ensure proper function of the terminal, before an imported file is saved into terminal memory, the file is checked for data integrity. If there are issues with the file (e.g. too many fields, invalid #, type of characters or file size) a pop-up error message is displayed and the file import is aborted automatically.

If a read or write error occurs during the USB file exchange, a synchronous error (pop-up message) is displayed, notifying the user of the error.

#### 2.8.4. Printing to USB

To execute a successful print to USB, the USB connection must be configured with a Demand Output assignment and linked to a print template and trigger associated with the USB port (refer to Appendix C, **Communications**).

When a print template is sent to a USB flash drive for the first time, the IND570 will automatically create a file structure on the root directory of the USB device. The top level filename is "IND570". Within the IND570 folder are folders for individual terminals. The unique serial number of each terminal is used as the filename. Figure 2-35 shows the file structure created by the IND570 during a full backup. Folders under the serial number folder will only be created as they are populated by the IND570 during data transfer/capture.

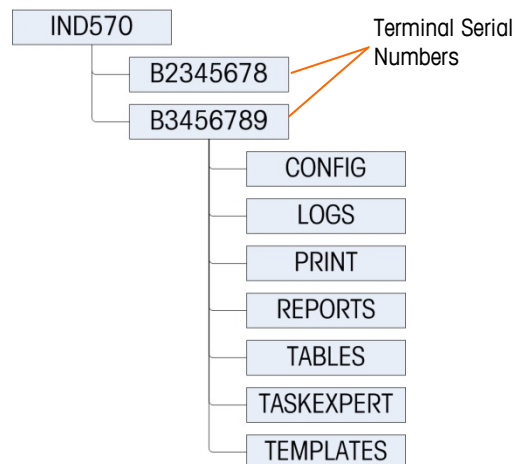

**Figure 2-35: USB File Structure**

When a USB port is configured to receive a Demand Output (print), a .txt file with the name of the template being printed is created to collect the data from each print that is executed. The maximum size of the template text file created and stored on a USB flash drive is limited to 5 MB, or the available free space on the USB flash drive, whichever is smaller.

An appropriate warning is shown either in the system line or as a pop-up message when the text file is 75% full. A second warning is shown when the .txt file is 90% and reminds the operator that the file must be emptied soon. If the .txt file exceeds 5MB, new records will not be recorded into the .txt file and a pop-up message informing that the text file is full is provided. The user must now remove/delete the .txt file from the USB and reinstall the USB flash drive to print additional records.

## 2.9. WiFi Operation

The optional WiFi module available for the IND570 communicates through the USB port of the terminal and provides a WiFi connection that meets IEEE 802.11 a/b/g/n standards. Two versions are available. One is intended to be installed in the harsh IND570 enclosure and protrudes out the rear panel through a semi-transparent watertight cover. The other version is intended to be mounted remotely using its 1.3m/4.2ft USB cable. The remote version includes a mounting bracket and protective housing.



**Figure 2-36: WiFi Module Options**

The WiFi connection is dual-band, supporting both 2.4 and 5 GHz, and is fully powered by the +5V on the USB port. The best available security protocol (WEP 64/128, WPA, WPA2, TKIP and AES/CCMP, LEAP, PEAP, EAP-TLS) is automatically selected during the initialization process. In ideal environments, the module can communicate at distances up to 150 meters (500 feet).

A multi-color LED on the module indicates its status and when connected, the signal strength is shown at the right of the metrology line on the IND570 terminal display.

When the optional WiFi module is installed, wireless access is provided for the communication methods described in the following sections.

### 2.9.1. Shared Data Server

The shared data server is the default function for the WiFi option, which provides access to the shared data server as long as no assignment is configured for the WiFi port. If a connection has been assigned to the WiFi port, the shared data server will no longer be available via WiFi.

Refer to section C.10., **Shared Data Server**, for details about communication to the shared data server through the WiFi port.

### 2.9.2. Demand Output

Operation of the demand output of the WiFi port is similar to operation of the EPRINT port for Ethernet. A device on the network can register for the data and receive template data per the connection assignment. The external device must open a connection to the selected WiFi port at the WiFi IP address in order to register. After registering, when a demand output is triggered, the selected template data will be available to the external device.

### 2.9.3. Remote Display

An IND570 configured as a remote display to a primary terminal can be connected to a wireless access point with the WiFi option. In this configuration, when the CLEAR, TARE, PRINT and ZERO keys on the remote display are pressed, the corresponding ASCII character (C, T, P and Z) will be transmitted to the primary terminal.

In this application, continuous weight data from the primary terminal is received via WiFi and displayed on the remote display.

Refer to section 4.6.4., **Configuration Utilizing WiFi Communication**, for details about configuring the WiFi port for use as a remote display assignment.

### 2.9.4. SICS

When the WiFi port connection is assigned to SICS, the port will provide bi-directional communication to a host using SICS commands and responses.

Refer to section C.7., **Standard Interface Command Set (SICS) Protocol**, for details about communicating with the IND570 using SICS interface on the WiFi port.

### 2.9.5. FTP

Files can be sent to or retrieved from the terminal at any time via FTP, using port 21 of the WiFi port. The WiFi FTP function behaves like the FTP function on the Ethernet port.

Refer to section C.11., **File Transfer**, for details about sending files to and receiving files from the IND570 via the WiFi port.

- Some FTP programs (for example FileZilla), cannot be used with the WiFi option for file transfer because they make two simultaneous connections and the IND570 WiFi module supports only one connection.

## 2.10. Error Management, Diagnostic Information and Service Options

### 2.10.1. Error Classification

Two classes of errors are detected in the IND570 terminal – **synchronous** and **asynchronous**.

#### 2.10.1.1. Synchronous Errors

Synchronous errors are those errors that occur as a direct result of a user interaction with the terminal. An example of a synchronous error is attempting to execute a Zero command when the weight on the scale is out of pushbutton zero range. IND570 will display a pop-up message window, helping the user see an immediate cause and effect from his actions. An example of a synchronous error message window is shown in Figure 2-37.





**Figure 2-37: Synchronous Error Pop-up Message**

In order to proceed with operation after a synchronous error window is displayed, the ENTER key must be pressed to acknowledge the error condition. The ENTER acknowledgement can be initiated on the terminal keypad, external keyboard ENTER key or a discrete input assigned as ENTER. No other user functions are allowed until the synchronous error is acknowledged.

### 2.10.1.2. Asynchronous Errors

Asynchronous errors are system errors that do not occur as a direct result of user interaction with the terminal. When an asynchronous error occurs, the user is alerted by a temporary message in the system line of the display. Examples of asynchronous errors include PLC and Remote Discrete I/O communication errors (see Figure 2-38).



**Figure 2-38: Asynchronous Error System Line Message**

### 2.10.1.3. Dual Classification Errors

Some terminal errors can have dual classification, as either synchronous (when triggered by user action) or asynchronous (when initiated by a PLC interface or remote discrete input). A failed Zero command is an example of the type of error that can be dual classified.

## 2.10.2. Error Log

IND570 provides an Error Log which records the details of system errors. As a general rule, asynchronous errors are recorded while synchronous errors are not. Each error record includes:

- **Date and time** of the error.
- An **error code** generated with each error instance to give information about the cause of the error.
- An associated **text message** for inclusion in reports or email alerts.



Refer to the **Maintenance | Configure/View | Error Log** section Chapter 3, **Configuration** and Appendix B, **Tables and Log File Structure**, for more information on the IND570 Error Log.

### 2.10.3. Information Recall



Press the INFORMATION RECALL  softkey to access the recall screen. Several softkeys appear, each providing access to specific terminal information.



Figure 2-39: Information Recall View

#### 2.10.3.1. Weight Recall

Press the WEIGHT RECALL softkey  to display the active Gross, Tare, and Net weight readings for the scale.

#### 2.10.3.2. System Information



Pressing the SYSTEM INFORMATION softkey  displays system information, including the terminal model (version) and serial number, Terminal ID #1, Terminal ID #2, Terminal ID #3 and installed software and hardware information. The terminal identification information is entered in setup. Refer to section 3.7.1, **Device**, in Chapter 3, **Configuration**, for more information about entering terminal identification information. Installed hardware and software fields are automatically populated.



Figure 2-40: System Information View

This system information can be printed with the PRINT softkey  via any connection with a Reports assignment.

##### 2.10.3.2.1. WiFi Recall

If the WiFi option is installed in the IND570, a WiFi RECALL softkey will be shown. This softkey provides access to view various data from the WiFi system including SSID, operating channel, type

of security used, signal strength, IP address, MAC of the WiFi module, identifying name of the WiFi module, module S/N, module firmware version and BSSID.

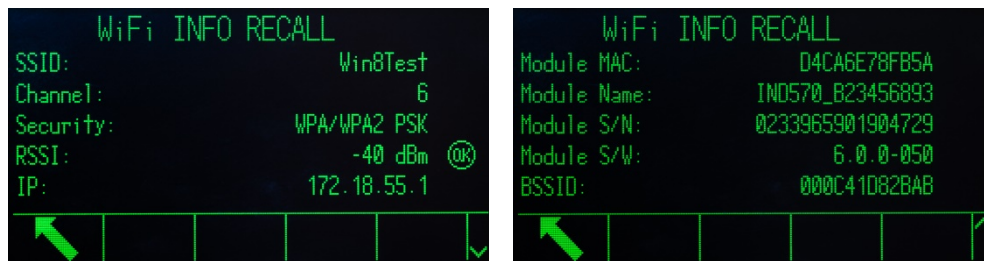

**Figure 2-41: WiFi Recall Screens**

The signal strength (RSSI) value is active when viewing the recall screen and can quickly indicate the current signal strength from the wireless access point (WAP).

2.10.3.2.2. Connected Devices Recall

A record of all equipment involved in a weighing system installation can be helpful when troubleshooting the system. The CONNECTED DEVICES softkey  displays peripheral device information that has been manually entered by the service provider or user. Refer to the **Terminal Device** section in Chapter 3, **Configuration** for more information about entering peripheral device information into the Connected Devices list.

2.10.3.2.3. Bluetooth Information Recall

When a SICSpro Cable-Free Floor Scale (CFS) is connected to the IND570, an additional softkey, with a Bluetooth icon , is available in the System Info Recall screen. Press this softkey to display information about the CFS platform.



**Figure 2-42: BLUETOOTH INFO RECALL Screens**

A message about the CFS platform may display when this screen is accessed – for example, “Platform battery low.” Press ENTER to confirm and dismiss this message, and to view the BLUETOOTH INFO RECALL screen.



**Figure 2-43: Battery Warning Message**

A key function of the BLUETOOTH INFO RECALL screen is to give an indication of signal strength and battery condition. Two conditions will cause the system to display a warning:

Warning	Explanation
Platform battery low	The battery has approximately 12 days of life remaining, at 8 hours per day usage. The battery is not rechargeable, and must be replaced when depleted.
Warning – Platform battery voltage very low	An urgent message: The battery has approximately 5 days of life left at 8 hours per day usage. This message will be shown as a pop-up over the home screen once every four hours, and must be acknowledged and dismissed by pressing ENTER. It will also display when the terminal is first powered up, and when the platform wakes from sleep.

- The remaining battery life is extended when the platform enters its deep sleep mode, or if it is used for less than 8 hours per day.



### 2.10.3.3. Metrology Recall

The METROLOGY RECALL softkey **M** displays the terminal metrology control number (MCN), whether the terminal is programmed as approved or not, along with the last calibration date and time. On the high-precision IDNet version, the Ident Code (calibration tracking) is also displayed.

#### 2.10.3.3.1. TaskExpert™ Checksum

If TaskExpert is installed the IND570, the TASKEPERT CHECKSUM softkey **TE** will appear on the Metrology Recall screen. The TaskExpert Checksum softkey displays the terminal calculated checksum for the custom application that has been loaded into the terminal. This calculated checksum is compared to the checksum embedded in the TaskExpert application. A match must occur for the application to run.



### 2.10.4. Service Icon

The service icon  is shown on the terminal display when system events or system errors occur that require the attention of a service provider (see Figure 2-5). To view information regarding the trigger of the service icon, press the INFORMATION RECALL  softkey, then press the SERVICE ICON softkey .

The Service Information Recall softkey  displays current system details that a user can pass on to a service provider to assist in troubleshooting and repair activities. System information displayed depends on terminal setup and activated terminal functions, but can include calibration and GWP status, recent service and error alerts, and service provider contact information (Figure 2-44).



**Figure 2-44: Service Information Recall View**

The PRINT softkey  will transmit this service information via any communication connection with a Reports assignment. Refer to the **Communication | Connections** in Chapter 3, **Configuration** for details on assigning data output ports. The SEND EMAIL softkey  on the Service Information Recall screen sends a manual email notification to any recipient programmed with “Service” as an email alarm setting. Refer to the **Communication | Email** and **Communication | Network** sections in Chapter 3, **Configuration**, for more information about enabling email alerts.

The service icon it will be automatically cleared if the circumstances that triggered the service icon are corrected or it can be manually cleared from the terminal display of the IND570 (refer to the **Maintenance | Run | Diagnostics | Reset Service Icon** section in Chapter 3, **Configuration**).

2.10.4.1.1. Terminal Status View 

The TERMINAL STATUS softkey  takes the user to the Terminal Status Report screens, where additional system performance details are available (Figure 2-45).







**Figure 2-45: Terminal Status Screens**

The Terminal Status feature provides the status of certain predetermined terminal functions and systems. The information fields displayed in the Terminal Status screen are populated when the TERMINAL STATUS softkey is pressed (Figure 2-44), so the data is always current when viewed or printed. The POWERCELL version included additional load cell information not shown here.

- If security is enabled, access to Terminal Status is limited to Maintenance level or higher.

The PRINT softkey  on the Terminal Status view will transmit a comprehensive report via any communication connection with a Reports assignment. Information displayed on the following terminal screens is included in the Terminal Status report:

- System Information Recall 
- Connected Devices table 
- Service Information Recall 
- Terminal Status 

Refer to the **Reports** section of Appendix C, **Communications** for more information regarding the content and structure of all Reports.

### 2.10.5. Automatic Email Alerts



When the Ethernet communication option is installed, IND570 provides an email function to automatically alert recipients when certain system events occur in the weighing system. Details on enabling the email function can be found in the **Communication | Network | Email Alert** section in Chapter 3, **Configuration**.

- In the event the IND570 loses connection to the network, email sent from the IND570 during the disconnected period is placed into a queue. When network connection is reestablished, the IND570 transmits any queued email.

The IND570 supports four categories of email alerts: Information, Warning, Failure and Service. When any of these alerts are triggered, all recipients that have been set up to receive a particular category of email alert are sent an email in a predefined format, containing details about the event as well as information about the transmitting device.

Table 5-9 (in Chapter 5, **Service and Maintenance**) lists the categories of system events that will trigger an automatic email alert.

#### **2.10.5.1. Manual Call for Service via Email**

In addition to the Automatic Alerts (Table 5-9), a manual call for service is also supported. A manual Service Alert can be triggered by pressing the SEND EMAIL softkey  at the bottom of the Service Info Recall page (Figure 2-44). When the SEND EMAIL softkey  is pressed, the user is provided an entry box on a new page to type in any additional user observations before actually sending the email. From this screen, pressing the EMAIL softkey  triggers the transmission of an email to any recipients registered for Service level alerts.

#### **2.10.6. InTouch<sup>SM</sup> Remote Services**

IND570 supports an embedded InTouch communication agent that, when enabled, will monitor the weighing system for performance anomalies, and in the event of a performance issue, will securely transmit encrypted information to a cloud-based InTouch Enterprise server. The encrypted data can include system information, alarm conditions and diagnostic files. METTLER TOLEDO remote service technicians actively monitor the InTouch Enterprise server, allowing for real-time and proactive response to performance issues.

Activation and configuration of the embedded InTouch Remote Service communication agent is not carried out without express permission from the user. Please refer to the **METTLER TOLEDO Services** page at the front of this manual for assistance in contacting a METTLER TOLEDO service provider for more information on the benefits of incorporating InTouch Remote Services into your location's service strategy.

For reference, InTouch alarms and events are listed in Table 5-9.



# 3 Configuration

This chapter covers

- Entering Setup Mode
- Exiting Setup Mode
- Setup Menu Tree
- Overview of Configuration
- Scale
- Application
- Terminal
- Communication
- Maintenance

This chapter provides information about how to configure the IND570 terminal's operating system. It describes access to the setup mode, where functions can be enabled, disabled, or defined by entering parameter values in specific setup screens.

## 3.1. Entering Setup Mode

The configuration of the IND570 terminal is accessed through the SETUP softkey .

Most of the setup menu is viewable by any user at any time. If user security has been enabled and a user is attempting to enter setup for the purpose of modifying terminal configuration, the user should first navigate to the Login branch at the very top of the setup menu (Figure 3-2) and enter a valid user name and password combination (Figure 3-1). Entry of a valid username and password combination will grant access to the user at the security level associated with the login.

Refer to the **User Security** section in Chapter 2, **Operation**, and section 3.7.5, **Users**, below, for further information about password setup and security levels.

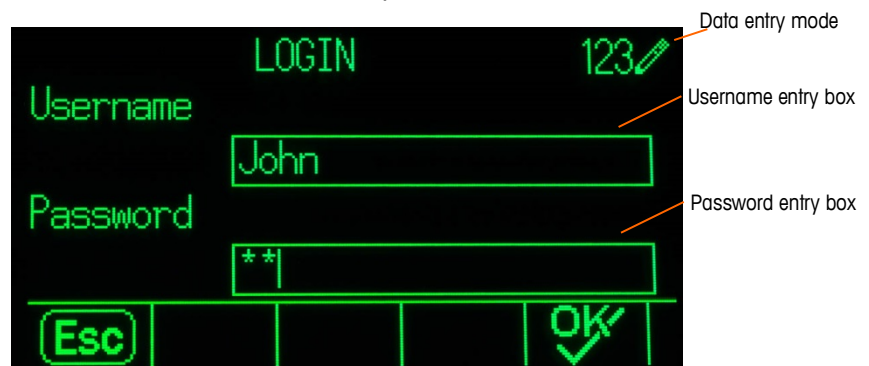



Figure 3-1: Login Screen

### 3.1.1. To Enter a Username

1. Press the ENTER key to access the **Username** entry box. The current data entry mode is identified at the right of the top line (see Figure 3-1).
  - Refer to **Data Entry** in Chapter 2, **Operation** for details on entering alphanumeric characters.
2. Use the keypad or external keyboard to enter the username in the username entry box. This field is case sensitive.
3. Press the ENTER key.

### 3.1.2. To Enter a Password

1. With focus on the **Password** field label, press the ENTER key and focus moves to the Password entry box.
2. Use the keypad or external keyboard to enter the password in the password entry box. This field is case sensitive. Note that asterisks are shown instead of the actual character entered.
3. Press the ENTER key.
4. After both the Username and Password have been entered, press the OK softkey . If the username and password are correct, the terminal goes into setup mode. Once the terminal is in setup mode, the setup menu tree displays.

## 3.2. Exiting Setup Mode

To exit the setup mode, select Home from the setup menu tree and press ENTER. The default weighing operation screen displays.

- As a quick alternative, press the far left softkey whenever the menu tree is displayed to exit the menu tree. If no other function is indicated on the far left softkey, it will typically function as an EXIT softkey .

## 3.3. Setup Menu Tree

Each line of the setup menu tree is referred to as a branch (see Figure 3-2). Some branches have additional sub-branches that become visible when the view of the main branch is expanded. If a branch has sub-branches, the collapsed symbol (☰) initially displays in front of the branch name. After the branch view has been expanded, the expanded symbol (☱) displays in front of the branch name and the additional branches become visible. Any branch that is not expandable is called a leaf node.

The first branch of the menu tree shown with focus is the Scale branch (Figure 3-2).



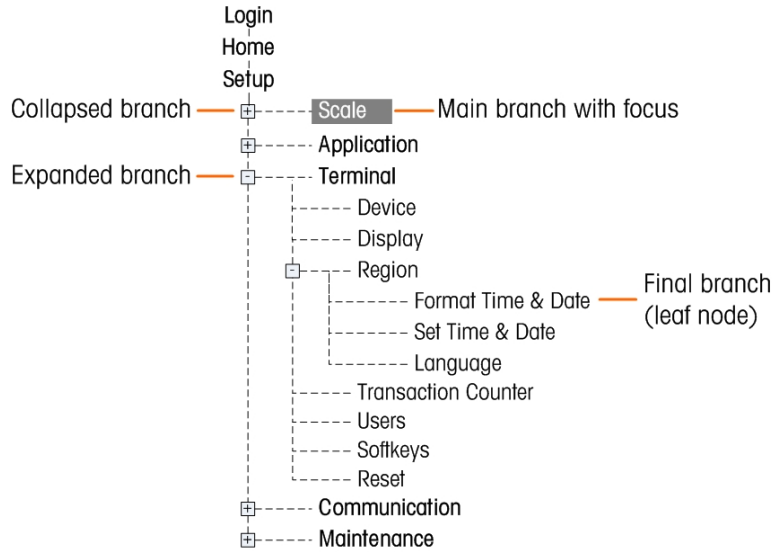

**Figure 3-2: Setup Menu Tree Example**

Use the UP and DOWN navigation keys to move focus through the branches of the setup menu tree.

Press the RIGHT navigation key to expand a branch and the LEFT navigation key to collapse a branch. When the focus is on a sub-branch, focus can quickly be moved back to the main branch by pressing the LEFT navigation key.

When a leaf node (singular, non-expandable) branch such as Device or Display is in focus, press the ENTER key to display the setup screen for that function.

### 3.3.1. Setup Screens

Setup screens enable access to data fields where parameters can be viewed, entered, or modified to configure the terminal to meet specific application function needs.

#### 3.3.1.1. Navigation

Press the UP and DOWN navigation keys to move through the field labels displayed on each setup screen, and to move to a second or third setup screen when more than one screen is used for configuration fields associated with a specific parameter (indicated by the presence of a scroll bar). The shaded portion of the scroll bar (see Figure 3-3) indicates which screen is displayed.

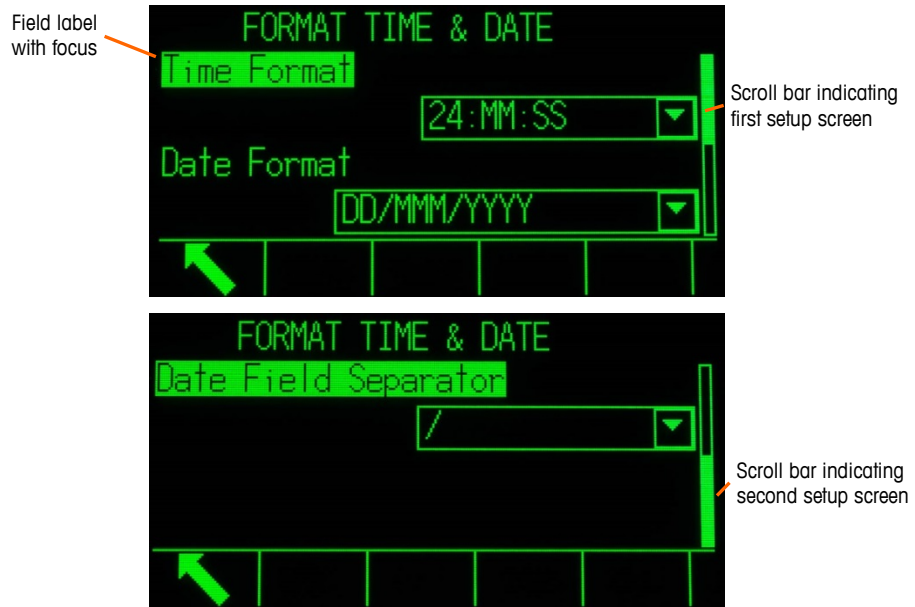

**Figure 3-3: Examples of Setup Screens (Format Time & Date)**

**3.3.1.2. Data Entry**

Press the ENTER key to move the focus from the field label to either the selection box or data entry box where data is to be entered or edited (see Figure 3-4).



**Figure 3-4: Setup Screen**

If the field values are presented in a selection box, the current selection will have focus when the ENTER key is pressed.

**3.3.1.2.1. To change the field value in a selection box**

1. Press the UP and DOWN navigation keys to scroll through the list and place the focus on the value to be selected.
  - Note that when viewing the last field in a selection box, pressing the DOWN navigation key again will move the focus to the top of the selection list. When viewing the first field in a selection list, pressing the UP navigation key will move focus to the last selection.
2. Press the ENTER key to accept the selection as the value for the field. The selection displays as the value for the field and the focus moves to the next field label.

If the field value is for a data entry box and alpha/numeric character entry is possible, the data entry mode will appear in the upper right of the display (Figure 3-1).

3.3.1.2.2. To change the field value using alpha/numeric characters

1. When a data entry box is first entered, the previous data (if present) is in focus. To replace previous data, use the alpha/numeric keypad to enter the desired value.

OR

Press the LEFT and RIGHT navigation keys to move the cursor into position if the value needs to be edited from a specific point rather than replaced. Position the cursor at the end of the data to be deleted and press the C key once for each character to be deleted.

2. Press the ENTER key to accept the entered alpha/numeric characters for the field. The entry displays as the value for the field and the focus moves to the next field label.

To exit a setup screen, press the EXIT softkey , which is in the first softkey position. The setup menu tree displays with the focus on the branch for the setup screen that was exited.

## 3.4. Overview of Configuration

The setup menu tree can be expanded to show every branch and leaf node in the terminal's configuration. Use the navigation keys to select the desired setup screen.

There are five major branches in the setup menu:

- Scale
- Application
- Terminal
- Communication
- Maintenance

Details for each branch are provided throughout this chapter. Figure 3-5 shows the setup menu tree with all possible branches expanded.

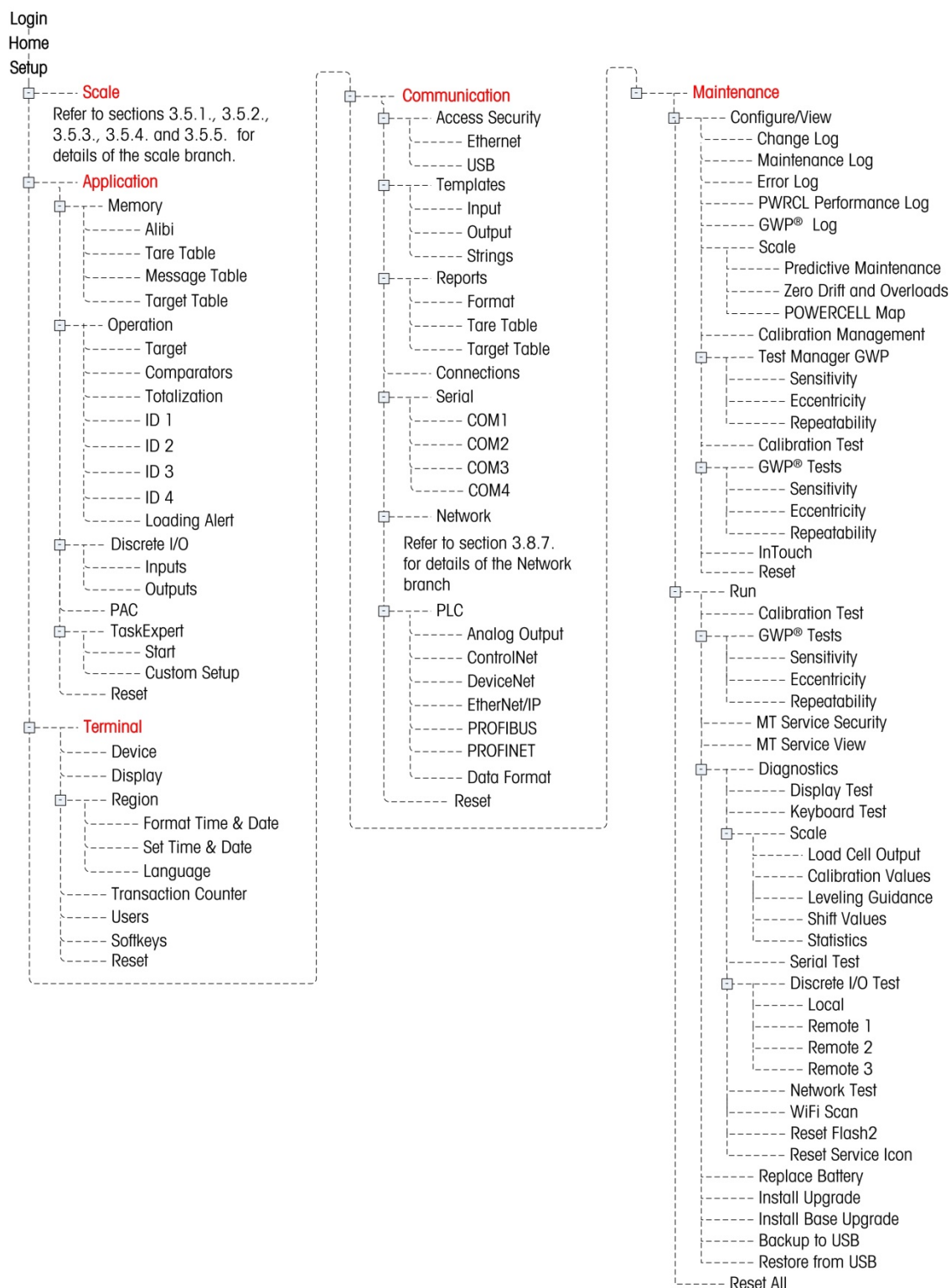

**Figure 3-5: The IND570 Menu Tree with All Branches Except Scale Expanded**

- The presence of setup menu branches will depend on installed options and, in some cases, configuration selections made in other areas of setup. For example, the TaskExpert branch is only available if the optional TaskExpert software module has been installed into the IND570.

## 3.5. Scale

- If the metrology switch is in the approved position (SW1-1 = ON), changes to protected parameters in the Scale branch are not permitted.

The Scale branch provides the following access to the configuration of the connected scale:

- Leaf nodes that are marked with an asterisk (\*) above will have different parameters depending on the connected scale type.

Each type of scale in the IND570 offers different parameters in the Scale branch. To simplify the scale programming process, each scale type is described in a separate section in this chapter. Refer to the correct section for the type of scale used.

- Analog Section 3.5.1, below
- IDNet Section 3.5.2, on page 3-24
- SICSpro Section 3.5.3, on page 3-34
- POWERCELL Section 3.5.4, on page 3-41
- Remote Section 3.5.5, on page 3-61

A Reset is present at the end of the branch to enable a limited reset to the factory default settings for the Scale branch parameters. Refer to Appendix A, **Default Settings**, for details.

### 3.5.1. Scale – Analog

#### 3.5.1.1. Type

The Scale Type screen permits a name to be assigned to the scale, displays the scale PCB type in the terminal (or allows the IND570 to be configured as a remote display for another terminal), provides a selection list for the Approval mode, and allows entry of the approval class and interval for the metrology line. The EXIT softkey  will return the display to the menu tree.

##### 3.5.1.1.1. Name

The Name field enables entry of the scale identification. Enter the scale name (an alpha-numeric string of up to 20 characters) in the Name entry box.

##### 3.5.1.1.2. Scale Type

The Scale Type field indicates which type of scale this terminal supports and allows selection of Remote Display mode. If Remote is selected, the approval, class and verified interval options will not be available. Choices are:

**Analog** [default for analog version], Remote

Refer to Chapter 4, **Applications**, for specific instructions on configuring the terminal for use as a remote display.

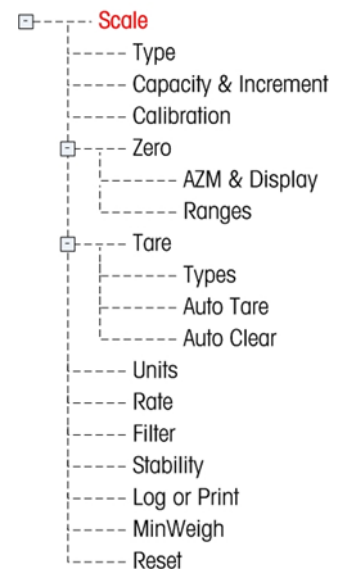

### 3.5.1.1.3. Approval

Approval refers to the metrological (weights and measures) approval configuration for the specific scale. The selection list includes:

**None** [default], USA, OIML, Canada, Australia, Argentina, Thailand, Korea

If the approval is configured as USA, OIML, Canada, Australia, Thailand or Korea and the metrology security switch, SW1-1, is set to ON, access to the Scale setup parameters in the menu tree will be limited to view only.

If the approval is configured as Argentina and the metrology security switch, SW1-1, is set to ON, access to the entire setup menu is prohibited. If an attempt is made to access the setup menu, an on-screen message will display stating "Access denied. Scale is Approved."

If an approval is selected but SW1-1 is not ON, it will not be possible to leave setup, and a message will appear: "Switch UNSECURED".

### 3.5.1.1.4. Class

The Class field selection is shown if an analog scale terminal is selected as approved. This selection must match the Weights and Measures approval class when the terminal is used in an approved mode. The Class information is included in the data shown in the metrological line at the top of the display. The selections are:

II, III [default], III HD, III L, IIII

### 3.5.1.1.5. Verified Interval

This parameter is shown only when the terminal has been programmed as Approved and Class has been selected as II. The Verified Interval indicates if the approved increment size is equal to the displayed increment size or if it is 10 times the displayed increment size. This information is included in the data shown in the metrological line at the top of the display.

**e=d** [default], e=10d

### 3.5.1.1.6. Power Up Delay

The Power Up Delay supports approval to the most stringent performance requirements of the European MID. This parameter only appears when the Approval on an analog scale has been set as "OIML". Settings for Power Up Delay include:

**Disabled** [default], Enabled

When Enabled, operation of the terminal is prohibited (except for setup access) until 5 minutes have expired. A process timer is provided in the terminal system line, and updates every 3 seconds (Figure 3-6).

It is strongly recommended to leave Power Up Delay disabled (default condition) unless the application/installation requires MID R61 approval for automatic gravimetric filling.



**Figure 3-6: Power Up Delay Shown in System Line**

### 3.5.1.2. Capacity & Increment

Use the Capacity and Increment setup screen to select primary units, set the number of ranges or intervals, program the capacity and increments sizes, and the blanking over capacity value.

When Remote is selected as the scale type, the capacity and increment size are available. These parameters are used to determine the size of the digits used in the weight display and should be entered based on the values from the master terminal.

#### 3.5.1.2.1. Primary Units

Set the primary units from the selection box choices, which include:

grams (g), **kilograms (kg)** [default], pounds (lb), tonnes (t), tons (ton)

#### 3.5.1.2.2. # Ranges/Intervals

Select the multi-interval or multiple range mode and set the number of ranges or intervals from the selections:

1 [default], 2 intervals, 2 ranges, 3 intervals, 3 ranges

#### >I1< - Range/Interval 1 Values

Specify the capacity and then the increment size for range or interval 1.

#### >I2< - Range/Interval 2 Values

When more than one range is selected, these parameters provide entry of the capacity and then the increment size for the second range or interval.

#### >I3< - Range/Interval 3 Values

When three ranges or intervals are selected, these parameters provide entry of the capacity and then the increment size for the third range or interval.

#### 3.5.1.2.3. Blank Over Capacity

Blanking of the display is used to indicate an over-capacity condition. Set the blank over capacity for the number of display increments that the terminal is permitted to go over capacity. For example, if capacity is set at 500 kg by 0.1 kg increments and the blank over capacity setting is 5 d, the terminal can display weights up to 500.5 kg. At weights over 500.5, dashed lines will display instead of a weight and demand data output is inhibited.

**3.5.1.3. Calibration**

The Calibration screens enable entry of a geo code adjustment value, the base serial number, calibration units, linearity adjustment, and analog gain jumper setting. This screen also provides access to the Service Mode of an IDNet scale. The Calibration branch is not accessible when the terminal is programmed as a Remote Display scale type.

3.5.1.3.1. Geo Code

Enter the geo code for the appropriate geo adjustment value for the current geographical location. Geo codes are numbered 0–31. Refer to Appendix D, **Geo Codes** to find the appropriate Geo Code for the installation location.

3.5.1.3.2. Base Serial Number

If appropriate, enter the connected scale base serial number in this field. An entry of up to 14 characters is possible.

3.5.1.3.3. Calibration Units

Calibration units are the same as the primary units selections, which include:

grams (g), **kilograms (kg)** [default], pounds (lb), tonnes (t), tons (ton)

3.5.1.3.4. Linearity Adjustment

Select the linearity adjustment from the selection box. Selections are as follows:

- Disabled** [default]      Use only zero and one span point
- 3 point                      Use zero, midpoint, and highpoint
- 4 point                      Use zero, lowpoint, midpoint, and highpoint
- 5 point                      Use zero, lowpoint, midpoint, mid-highpoint, and highpoint

3.5.1.3.5. Analog Gain Jumper

The analog gain jumper setting on the Main PCB can be either 2 mV/V or 3 mV/V. The terminal is shipped from the factory in the 3 mV/V setting. In order for the CalFree™ feature to operate properly, the selected parameter must indicate the physical position of the jumper on the Main board. Refer to the **PCB Jumper Positions** section in the **IND570 Installation Manual**, for more about the jumper location. The jumper settings are:

- 2 mV/V                      Jumper installed on both pins
- 3 mV/V** [default]      Jumper installed on just one pin

If this parameter is not set correctly, the CalFree calibration feature will not be accurate.

3.5.1.3.6. Calibration Soffkeys

The soffkeys shown on the last Calibration setup screen are used for calibration procedures.

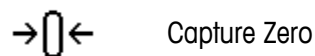





Capture Span



Step Calibration





CalFree

CalFree

### Capture Zero

The CAPTURE ZERO softkey  triggers an independent operation to reset the zero condition of the scale.

To capture zero



1. Press the CAPTURE ZERO softkey .
2. A message displays that directs the user to empty the scale and press the START softkey . The raw counts are displayed in a box at the lower right corner of the display.
3. Empty the scale and press the START softkey . The status of the capture zero operation displays.
  - Press the ESCAPE softkey  to abort the zero process and return the display to the previous screen.
4. When the operation is complete, a final status message displays that verifies the completion of the zero capture operation.
  - If motion is present during the zero capture process, the terminal will process the dynamic weight readings then display a warning message indicating dynamic weight values were used. This message provides choices of No and Yes to either reject or accept the dynamic weight calibration. Move focus to the desired action then press the ENTER key.
5. If the zero span operation was successful, a verification message that reads "Capture Zero OK" displays. If the capture zero operation was not successful, an error message that reads "Zero Failure" displays. If the zero fails, repeat the zero capture procedures. If the zero continues to fail, contact a local METTLER TOLEDO representative for assistance.
6. Press the EXIT softkey  to return to the Calibration screen.

### Capture Span

The CAPTURE SPAN softkey  initiates a sequence to capture span that can be performed independently of capturing zero.

To capture span:



1. Press the CAPTURE SPAN softkey . The Capture Span setup screen displays.
2. Enter the weight for test load 1 and all other test loads if linearity has been enabled. Each test load value must be larger than the previously entered test load value. Press the ENTER key.
3. Prompts to "Place test load" then "Press START" are shown. The raw counts are displayed in a box at the lower right corner of the display.



4. Place test load weight 1 on the scale.
5. Press the START softkey . The status of the weight capture operation displays. When the operation is complete, a status message displays that verifies the completion of the weight capture.
  - If needed, press the ESCAPE softkey  to abort the calibration process and return the display to the previous screen.
6. After the first calibration step has completed, the menu will either display a prompt for the next calibration weight to be added (if 2, 3, or 4 test load steps are enabled by the linearity adjustment parameter) or will show a successful or failed calibration sequence.
  - If motion is present during the span capture process, the terminal will process the dynamic weight readings then display a warning message indicating dynamic weight values were used. This message provides choices of No and Yes to either reject or accept the dynamic weight calibration. Move focus to the desired action and press the ENTER key.
7. Repeat steps 4-5 for test loads 2, 3, and 4 if enabled by linearity adjustment.
8. If the capture span operation was successful, a verification message that reads "Capture Span OK" displays. If the capture span operation was not successful, an error message that reads "Calibration Failure" displays. If the calibration fails, repeat the capture span procedures. If the calibration continues to fail, contact a local METTLER TOLEDO representative for assistance.
9. Press the EXIT softkey  to return to the Calibration screen.

### Step Calibration

The STEP CALIBRATION softkey  initiates a procedure that enables a "build-up" calibration for tanks and hoppers. For step calibration, the same amount of test weight is added for each step of the calibration procedure.

To perform a step calibration



1. Press the STEP CALIBRATION softkey . The Step Calibration setup screen displays.
2. Enter the target weight for the test load (the same amount of test load weight is used in each step).
3. Press the START softkey . The Step Calibration screen displays. This screen shows an active (live) weight display (using the current span factor), the intended target weight as entered on the previous screen, and the next step for the operator "Add test weight."
4. Add test weight to the tank/hopper as prompted by the display. Each time test weight is added to the scale, the active display shows the weight.
5. When the full amount of test weight has been added, press the OK softkey . The test load is captured and span factors are saved. During the time the weight is captured and the new span factor is being calculated, the display "Add test weight" changes to "Capturing span." The display then changes to the next prompt "Remove test weight then fill to target."
6. Remove the test weight. The active display returns to zero.
7. Fill the tank/hopper with a substitute material up to near the target weight. It does not have to be the exact target weight.

8. Press the OK softkey . The target weight value recalculates to show the substitute material weight plus the initial intended target weight. The display changes to the next prompt "Add test weight."
9. Add test weight to the tank/hopper. The active display shows the weight.
10. Press the OK softkey . If the actual weight does not equal the target, a new span factor calculates and the display changes to "Capturing span." The active weight display changes to match the target weight value. The display changes to the next prompt "Remove test weight then fill to target."
11. Remove the test weight. The active display returns to the previous weight that displayed for the last test load.
12. Repeat steps 7 through 11 until an appropriate number of calibration steps have been completed for the specific application.
13. Press the EXIT softkey  at any step in the procedure to stop the step calibration process and return to the Calibration screen.

### CalFree

The CALFREE softkey  provides access to the span calculation screen for calibration of a scale without test weights. Before beginning the CalFree procedure, make sure the correct value for the Analog Gain Jumper has been entered. An incorrect value for this setting will cause errors in the CalFree calculation.

To perform calibration of span using CalFree

1. Press the CALFREE softkey . The CalFree screen displays.
2. Enter the load cell capacity then press the ENTER key.
  - The total load cell capacity should be entered here. For example, for a tank with three 5000 kg cells, cell capacity would be 3 x 5000 kg or 15000 kg.
3. Enter the rated load cell output value then press the ENTER key.
  - If multiple load cells are used, the average output of all cells should be entered here. The average output is determined by adding the output values of all cells together and dividing the sum by the number of cells.
4. Enter an estimated preload value in the associated field. Estimated preload is an optional entry. During calculation, the terminal tests for analog/digital (A/D) converter input saturation at full scale capacity. Estimated preload is included in this calculation if entered in this field. If the preload is unknown, leave this field blank.
  - This preload value is used only to determine overload conditions and is not used as a zero reference point. The zero reference point must be captured using the normal zero calibration procedure.
5. Press the OK softkey . The span is calculated using the parameters entered.
6. If the calibration operation was successful, a verification message that reads "Calibration OK" displays. If the calibration operation was not successful, an error message that reads

“Calibration Failure” displays. If the calibration fails, repeat the CalFree procedure. If the calibration continues to fail, contact a local METTLER TOLEDO representative for assistance.

7. Press the EXIT softkey  to return to the Calibration screen.

#### 3.5.1.3.7. Analog Saturation Test

During the calibration process, the IND570 will determine if there is a potential for analog section saturation. The IND570 will compare the available number of counts with the captured span to confirm that the desired capacity is achievable. If the potential exists to saturate the analog section before system capacity is reached, the IND570 will display a warning message and recommendation that the system be recalibrated with a new, lower, capacity.

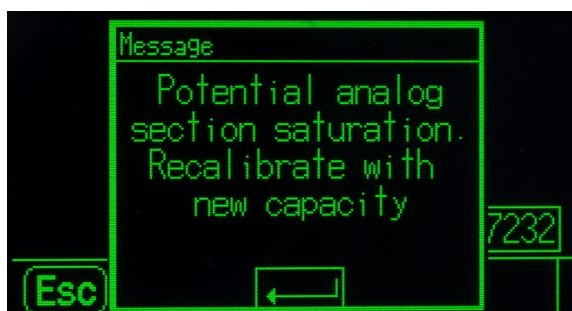

**Figure 3-7: Analog Saturation Warning**

This message functions only as a recommendation to recalibrate. After the warning message is acknowledged by pressing the ENTER key, the user is presented with the “Capture Span OK” screen and the BACK softkey. Service personnel should then carry out the following:

Confirm that the analog gain jumper on the main board is set correctly for the actual load cell output, either 2mV/V or 3mV/V (refer to the **IND570 Installation Manual**, for jumper positions).

If the analog gain jumper is correctly set, the scale should be recalibrated with a lower capacity. Potential analog section saturation does not force a failure in calibration.

■ **IMPORTANT:** It is critical that service personnel follow the recommendation to recalibrate or confirm that the analog output jumper is properly positioned on the main board. Analog section saturation will result in a ‘freeze’ of the display, where the display is no longer showing increases in weight, creating the possibility of overfills and spills during the weighing process.

#### 3.5.1.4. Zero

This section provides access to Auto Zero Maintenance (AZM) settings, under zero blanking, power-up zero, and pushbutton zero parameters.

##### 3.5.1.4.1. AZM & Display

AZM (Automatic Zero Maintenance) is a means of tracking zero when the scale is empty. AZM compensates for conditions such as terminal or load cell drift or slow debris buildup on a scale platform.

##### Auto Zero

Use the Auto Zero parameter to select the auto zero maintenance parameter. The choices include:

Disabled, **Gross** [default], Gross and Net

#### **Auto Zero Range**

Set the auto zero range for the number of divisions (d) around the current zero setting in which auto zero will operate.

#### **Under Zero Blanking**

Blanking of the display is used to indicate an under-zero condition when the weight on the scale falls below the current zero reference. Set the under zero blanking for the number of divisions (d) that the terminal is permitted to go under zero before blanking.

- A value of 99 disables blanking under zero and the terminal will display a weight as far under zero as possible.

#### **Power Up**

This step determines if at power up, the terminal will restart with the most recent zero reference point it had before power down or if it will reset to the calibrated zero reference. A Power Up setting of Restart enables the terminal to reuse the most recent zero reference weight after a power cycle so it returns to the same, previously displayed gross weight value. If reset is selected, the last zero calibration value will be used as the zero reference point. The choices are:

Reset, **Restart** [default]

#### **Timed Zero**

When enabled, the Timed Zero function monitors the weighing system to ensure that the system sees the center of zero condition at stability within a certain pre-determined time or the scale is disabled. The following choices are available for enabling the Timed Zero function:

**Disabled** [default], 10 minutes, 15 minutes, 30 minutes

It is strongly recommended to leave Timed Zero disabled (default condition) unless the application/installation requires MID R51 approval for automatic catchweighing equipment.

#### 3.5.1.4.2. Ranges

Use the settings on the Ranges screen to enable or disable Power Up Zero capture and Pushbutton Zero and to set the ranges around the original zero condition for the scale for applying these functions.

#### **Power Up Zero**

If Power Up Zero is enabled, the terminal tries to capture zero upon power up and a range within which zero will be captured is shown and is programmable. If Power Up Zero is disabled, the initial zero reference at power up will revert to the most recent zero reference point or to calibrated zero based on the Power Up selection on the AZM & Display screen. The selections are:

**Disabled** [default], Enabled

### Power Up Zero Range

If Power Up Zero is enabled, –Range and +Range fields will display for setting the range around the original calibrated zero of the scale within which Power Up Zero can be applied. The range units are percent.

For example, if the +Range setting for Power Up Zero is set at 2%, Power Up Zero will only occur when the weight reading on the scale is less than 2% of scale capacity above the original calibrated zero reference. If the –Range setting for pushbutton zero is set at 2%, Power Up Zero will only occur when the weight reading on the scale is less than 2% of scale capacity below the original calibrated zero reference.

- If Power Up Zero capture is enabled and the weight on the scale is outside of the zero capture range, the display will indicate EEE until the weight is adjusted to be within this range and zero is captured.

### Pushbutton Zero

If Pushbutton Zero is enabled, the keypad ZERO pushbutton will operate to capture new zero reference points. The choices for pushbutton zero are:

Disabled, **Enabled** [default]

If Pushbutton Zero is Disabled, execution of a remote zero is still possible via SICS, CPTZ, SMA commands from a PC, a discrete input or from PLC commands. To set the zero range for these remote zero functions, first enable the Pushbutton Zero, select the pushbutton zero range and then disable the Pushbutton Zero.

### Pushbutton Zero Range

If Pushbutton Zero is enabled, –Range and +Range fields will display for setting the range around the original calibrated zero of the scale within which Pushbutton Zero can be applied. The range units are percent.

For example, if the +Range setting for Pushbutton Zero is set at 2%, Pushbutton Zero can only be used when the weight reading on the scale is less than 2% above the original calibrated zero reference. If the –Range setting for Pushbutton Zero is set at 2%, the Pushbutton Zero can only be used when the weight reading on the scale is less than 2% below the original calibrated zero reference.

#### 3.5.1.5. Tare

Tare is used to subtract the weight of an empty container from the gross weight on the scale to determine the net weight of the contents. Tare is inhibited if the scale is in motion. This branch provides access to program the tare types, auto tare and auto clear tare parameters.

##### 3.5.1.5.1. Tare Types

Use the Tare Types setup screen to enable or disable pushbutton tare, keyboard tare, and net sign correction.

### Pushbutton Tare

When pushbutton tare is enabled, the front panel tare key  can be pressed when an empty container is on the scale to determine tare. The terminal displays a zero weight and net mode. When the container is loaded and placed back on the scale, the terminal displays the net weight of the contents. The selections include:

Disabled, **Enabled** [default]

If Pushbutton Tare is Disabled, execution of a remote Tare is still possible via SICS, CPTZ, and SMA commands from a PC, a discrete input, or using PLC commands.

### Keyboard Tare

When keyboard tare is enabled, the known value for the empty weight of a container (tare) can be entered manually (preset tare). The terminal will then display the net weight of the contents of the container. Keyboard tares are automatically rounded to the closest display division. Choices are:

Disabled, **Enabled** [default]

### Net Sign Correction

Net sign correction enables the IND570 terminal to be used for both shipping (inbound empty) and receiving (inbound loaded) operations. If net sign correction is enabled, the terminal will switch the gross and tare weight fields on the printed ticket, if necessary, so that the larger weight is the gross weight, the smaller weight is the tare weight, and the difference is always a positive net weight. Net sign correction affects the printed data output, the recalled weight display and the displayed weight. Continuous data output will continue to show a negative net weight value. The choices for Net Sign Correction are:

**Disabled** [default], Enabled

Net sign correction will operate with pushbutton tare, preset tare, or tare records stored in the Tare Table. An example of weight values with and without net sign correction is shown in Table 3-1. In this example, the tare register value is 53 kg and the live weight on the scale is 16 kg.

**Table 3-1: Weight Values With and Without Net Sign Correction**

Printed and Displayed	Net Sign Correction	
	Disabled	Enabled
Gross	16 kg	53 kg
Tare	53 kg	16 kg
Net	- 37 kg	37 kg

- When net sign correction is enabled, the tare weight field in the recall display will be labeled with the letter "M" to indicate "Memory" instead of "T" or "PT".

#### 3.5.1.5.2. Auto Tare

Use the Auto Tare screen to enable or disable automatic tare and to set the tare and reset threshold weights, and enable or disable motion check.

### Auto Tare

When auto tare is enabled, the tare weight is taken automatically when a container above the threshold weight is on the scale and settles to no-motion. Selections are:

**Disabled** [default], Enabled

### Tare Threshold Weight

When weight on the scale platform exceeds the programmed tare threshold value and settles to no-motion, the terminal automatically tares.

### Reset Threshold Weight

The reset threshold weight must be less than the tare threshold weight. When the weight on the scale platform falls below the reset threshold value, such as when a load has been removed, the terminal automatically resets the auto tare trigger, depending upon the programming of motion checking.

### Motion Check

When enabled, the scale must detect a non-motion condition below the reset value to reset the auto tare trigger. The choices are:

Disabled, **Enabled** [default]

#### 3.5.1.5.3. Auto Clear

Use the Auto Clear screen to program auto clear tare, clear after print, to set the clear threshold weight, and enable or disable motion checking for auto clearing of tare.

### Auto Clear Tare

To clear tare automatically when the scale returns to below the threshold weight, enable the auto clear tare setting. Selections include:

**Disabled** [default], Enabled

### Clear Threshold Weight

The Clear Threshold Weight parameter is shown only when Auto Clear Tare is enabled. When the gross scale weight exceeds then falls below the programmed clear threshold weight value, the terminal automatically clears tare and returns to gross mode.

### Motion Check

The Motion Check field displays only when Auto Clear Tare is enabled. Enable the motion check setting to prevent auto clear from occurring when the scale is in motion. The choices are:

Disabled, **Enabled** [default]

### Clear After Print

To clear tare automatically after printing, enable the clear after print setting. Possible settings include:

**Disabled** [default], Enabled



### Clear With Zero

To clear tare automatically when capturing zero from the net mode, enable the clear with zero setting. Choices are:

**Disabled** [default], Enabled

### Power Up

A Power Up setting of Restart enables the terminal to reuse the last tare weight after a power cycle. If Reset is selected, the terminal returns to gross mode upon power up and the last tare weight after the power cycle is cleared. Selections are:

**Restart** [default], Reset

## 3.5.1.6. Units

This setup screen enables the selection of a second and a third unit and determines which unit is used at power up. If printing of two units is required, establish Third Units. Both Primary and Third units can be printed simultaneously in an output template.

### 3.5.1.6.1. Second Unit

Use the Second Unit selection box to select a second weighing unit. Only one custom unit is possible.

Available weighing units include:

**None** [default], Custom, pennyweight (dwt), grams (g), kilograms (kg), pounds (lb), pounds-ounces (lb-oz), ounces (oz), troy ounces (ozt), tonnes (t), tons (ton)

### 3.5.1.6.2. Third Unit

Use the Third Unit selection box to select a third weighing unit. Possible weighing units are:

**None** [default], Custom, pennyweight (dwt), grams (g), kilograms (kg), pounds (lb), pounds-ounces (lb-oz), ounces (oz), troy ounces (ozt), tonnes (t), tons (ton)

### 3.5.1.6.3. Power Up

Power up units defines the units the terminal defaults to after power up.

**Primary Units**      The terminal restarts in primary units

**Restart** [default]      The terminal restarts with whichever units were last displayed before the power cycle

### 3.5.1.6.4. Custom Factor

This parameter is shown only if a Custom unit is selected. Enter a multiplication factor for the custom unit in this field, such as 0.592 or 1.019. The primary unit is multiplied by the custom factor to obtain the custom value.

3.5.1.6.5. Custom Name  
 This parameter is shown only if a Custom unit is selected. Use the alpha keys to enter the name for the custom unit. Up to 12 characters may be entered. The terminal displays the first three letters of the custom name in the units area of the display when custom units are in use.

3.5.1.6.6. Custom Increment  
 This parameter is shown only if a Custom unit is selected. Enter a custom increment in this field, such as 0.1 or 0.5. This step controls both the decimal position and the increment size of the custom unit value.

**3.5.1.7. Rate**

A Rate, expressed as change in primary or secondary weight units per time unit, may be programmed for display on the IND570 and/or used in controlling discrete outputs – for example as the source for a Comparator (refer to section 3.6.2.2.1, and the **Comparators: Configuration and Operation** section of Chapter 4, **Applications**, for more details).

- The Rate display is selectable for display in the auxiliary display area below the weight display. Refer to section 3.7.2.4, **Terminal I Display I Auxiliary Display**, for more information on using the auxiliary display.

If the weight information in the terminal becomes invalid, the Rate display will show 0.000. The following Rate parameters can be configured:

3.5.1.7.1. Weight Units

Weight Units define which weight unit will be used for the rate calculation.

<b>None</b> [default]	Rate function is disabled
Primary	Primary weight units are used
Secondary	Secondary weight units are used. A secondary unit must be enabled for this choice to be shown.

3.5.1.7.2. Time Units

Time Units determine what time reference will be used for the rate value. Choices include:

**Seconds** [default], Minutes, Hours

3.5.1.7.3. Measurement Period

The Measurement Period value sets the frequency of weight measurements. Choices are:

0.5 seconds, **1 second** [default], 5 seconds

3.5.1.7.4. Output Average

Output from the rate function is set by a computed rolling average of measurements. This possible range of values is 1 to 99 seconds, with a default value of **5**. The Output Average value should be sufficiently larger than the Measurement Period to allow the terminal to take multiple measurements for each average.

### 3.5.1.8. Filter

The analog version IND570 terminal has a low-pass, multi-pole vibration filter that can be set for several conditions when using analog load cells. The heavier the filtering, the slower the display settling time will be. This screen is not accessible when Remote is selected as the scale type.

#### 3.5.1.8.1. Low Pass Frequency

Low pass frequency is the frequency above which all disturbances are filtered out. The lower the frequency, the better the disturbance rejection, but the longer the settling time required for the scale. Values from 0.2 to 9.9 are possible but values below 1.0 should not be used due to the extremely long settling time. The default value is **2.0** Hz.

#### 3.5.1.8.2. Low Pass # of Poles

The number of poles determines the slope of the filtering cutoff. For most applications, a slope value of 8 is acceptable; however, decreasing this number will improve settling time slightly. Choices are:

2, 4, 6, **8** [default]

#### 3.5.1.8.3. Notch Filter Frequency

The notch filter allows selection of one specific frequency above the low pass filter value that can also be filtered out. This enables setting the low pass filter lower to filter out all but one frequency (that the notch filter will handle) and obtain a faster settling time. Values from 0 (Disabled) to 99 are possible with a default value of **30** Hz.

#### 3.5.1.8.4. Stability Filter

The stability filter works in conjunction with the standard low pass filter to provide a more stable final weight reading. The setup choices include

**Disabled** [default], Enabled

- The stability filter should only be used in transaction weighing applications, since the nonlinear action of the filter switching may cause inaccurate cutoffs in batching or filling applications.

### 3.5.1.9. Stability

The IND570 terminal includes a stability detector (weight in motion). The Stability setup screen enables setting a motion range, no-motion interval and timeout period.

#### 3.5.1.9.1. Motion Range

Sets the motion range to the weight value (in divisions) that the weight is permitted to fluctuate and still have a no-motion condition. Values from 0.1 to 99.9 are possible with the default value being **1.0** d.

#### 3.5.1.9.2. No-motion Interval

The no motion interval defines the amount of time (seconds) that the scale weight must be within the motion range to have a no-motion condition. Values from 0.0 (motion detection disabled) to 2.0 are possible, the default value being **0.3** seconds. A shorter interval means that a no-motion condition is more likely, but may make weight measurement less precise.

## 3.5.1.9.3. Timeout

Defines the period (in seconds) after which the terminal stops attempting to perform a function that requires a no-motion condition (such as a zero, tare or print command) and aborts the function. This timeout is used regardless of the source of the command such as the keypad, discrete input, PLC or SICS. Values from 0 to 99 are possible with the default value being **3** seconds. A smaller value means that less time will be used to check for no-motion before aborting a command. When a value of 0 is entered, there must be no-motion when a command is given or it will fail immediately. A value of 99 is a special condition which permits the terminal to wait indefinitely for a no-motion condition - a command would never be aborted.

3.5.1.10. **Log or Print**

The Log or Print setup branch is where the thresholds to control how and when a demand data output is triggered. Normal demand mode printing occurs whenever a print request is made, providing there is no motion on the scale and the weight is above gross zero (a negative gross weight will not be printed).

The weight values entered are the gross weight values in primary units. Gross weight in primary units is used regardless of whether the IND570 is in Gross or Net mode and regardless of the units that are displayed.

## 3.5.1.10.1. Minimum Weight

The minimum weight setting is the threshold below which log or print functions will not initiate. Primary units are displayed for this field.

## 3.5.1.10.2. Interlock

Interlock prevents repeat logging and printing. When enabled, this interlock requires that the live weight reading be reset according to the **Reset On** parameter setting (see below). The live weight must then settle to a weight greater than the Minimum Weight value (see above) before responding to the next log or print request. Choices are:

**Disabled** [default], Enabled

## 3.5.1.10.3. Automatic

This parameter triggers an automatic log and print request every time the weight on the scale settles to a positive value that is larger than the entered Threshold Weight value (see below). After the initial log or print, the automatic trigger must reset per the Reset On parameter setting (see below) before the next automatic log and print can occur. The possible selections for this parameter are:

**Disabled** [default], Enabled

If Automatic is set to Disabled, the Threshold Weight field does not appear.

## 3.5.1.10.4. Reset On

The reset of Interlock and Automatic printing or logging can be based on weight threshold or weight deviation values. Select the desired operating mode and enter the weight value in the "Reset On" field. The choices include:

Deviation	The weight must change more than this absolute value for the Interlock and Automatic print to reset
-----------	---

**Return** [default] The weight must return to below this value for the Interlock and Automatic print to reset

If both Interlock and Automatic settings are disabled, the Reset On field does not display.

If Reset On is set to Deviation, The Threshold Weight and Motion Check fields do not display.

3.5.1.10.5. Threshold Weight

The Threshold Weight is the value above which an Automatic logging or printing of data can/will be triggered. Threshold Weight does not appear if Automatic is set to Disabled or if Reset On is set to Deviation.

3.5.1.10.6. Motion Check

Enable the motion check setting to prevent interlock and automatic log and print functions from resetting when the scale is in motion below the "Reset On" return point. Motion Check does not appear if Reset ON is set to Deviation. Choices are:

**Disabled** [default], Enabled

**3.5.1.11. MinWeigh**

If the current net weight is greater than or equal to the MinWeigh value, all terminal functions behave normally. If the absolute value of the net weight is less than MinWeigh, the weight display includes a flashing MinWeigh symbol  to the left of the weight. If the user attempts to record the weight while in this condition, the printout will include an asterisk (\*).

3.5.1.11.1. MinWeigh

This selects the operating mode of the MinWeigh feature. Choices include:

- Disabled** [default] The MinWeigh feature will not operate.
- Calculated The MinWeigh feature will operate and the MinWeigh value will be calculated based on measurement values entered.
- Direct Entry The MinWeigh feature will operate and the MinWeigh value will be directly entered by hand.

3.5.1.11.2. Calculated Mode

When **Calculated** is selected, the user is prompted to enter the uncertainty  $U_0$ , c factor, tolerance percent, and safety factor in data entry boxes. The new MinWeigh value is then computed using these values. The MinWeigh value can be viewed but not directly edited in this mode. Where:

- Uncertainty  $U_0$  Uncertainty in measurement as the applied load approaches 0.  $U_0$  is computed differently in each country and is entered in Primary units of measure.
- Uncertainty c Uncertainty factor related to the portion of uncertainty in measurement that is proportional to the applied load.
- Tolerance Tolerance in percent, which reflects the tolerances required for the specific process and facility. The range is 0.1%–99.9%.

**Safety Factor** To calculate the minimum weight the safety factor is usually  $SF = 1$ . However, if the customer would like to recalculate this number for purposes of more closely matching a GWP Recommendation this value will generally be specified by the customer starting at 2. The integer value range is 1–10 and is used to determine the exclusion range.

3.5.1.11.3. Direct Entry Mode

For **Direct Entry** of a MinWeigh value, user enters the desired value for MinWeigh directly in the MinWeigh data entry box. The MinWeigh value is entered in Primary units of measure.

**3.5.1.12. Reset**

Refer to section 3.5.6 on page 3-68.

**3.5.2. Scale – IDNet**

Metrological and some environmental parameters are accessed and stored in the load cell for the IDNet interface. So the Scale branch has a reduced set of parameters. Access to the setup in the IDNet load cell is called the Service Mode and is accessible from a softkey on the Calibration screen.

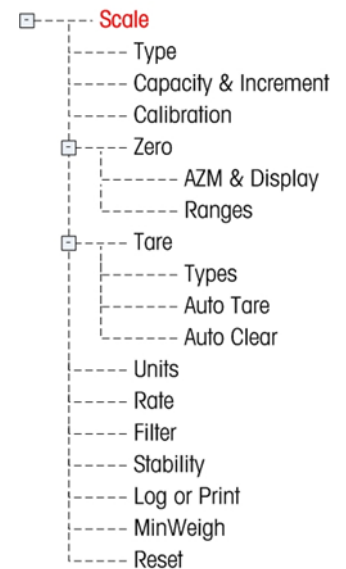

**3.5.2.1. Type**

The Scale Type screen permits a name to be assigned to the scale, displays the scale PCB type in the terminal (or allows the IND570 to be configured as a remote display for another terminal), provides a view of the Approval mode, and allows entry of the approval class and interval for the metrology line. The EXIT softkey will return the display to the menu tree.

3.5.2.1.1. Name

The Name field enables entry of the scale identification. Enter the scale name (an alpha-numeric string of up to 20 characters) in the Name entry box.

3.5.2.1.2. Scale Type

The Scale Type field indicates which type of scale this terminal supports and allows selection of Remote Display mode. Choices are:

**IDNet** [default for IDNet version], Remote

Refer to Chapter 4, **Applications**, for specific instructions on configuring the terminal for use as a remote display.

3.5.2.1.3. Class

Class is shown if the base has been programmed as Approved. This selection must match the Weights and Measures approval class. The Class information is included in the data shown in the metrological line at the top of the display. The selections are:

II, III [default], III HD, III L, IIII

#### 3.5.2.1.4. Verified Interval

This parameter is shown only when the scale is Approved and Class has been selected as II. The Verified Interval indicates if the approved increment size is equal to the displayed increment size or if it is 10 times the displayed increment size. This information is included in the data shown in the metrological line at the top of the display.

**e=d** [default], e=10d

### 3.5.2.2. Capacity & Increment

Use the Capacity and Increment setup screen to view primary units and expand x10 mode.

#### 3.5.2.2.1. Primary Units

View the primary units as programmed in the base, which include:

grams (g), kilograms (kg), pounds (lb)

#### 3.5.2.2.2. X10 Always

X10 Always locks the IDNet base into a higher resolution weight display. If the X10 Always mode is enabled, the high resolution weight data from the IDNet base displays at all times and the EXPAND BY 10 softkey **x10** (if configured to display) is inactivated. Selections include:

**Disabled** [default], Enabled

The weight unit displayed is the weight unit that the IDNet scale base was calibrated in (the Primary Unit) and cannot be switched to another weight unit.



### 3.5.2.3. Calibration

The Calibration screens enable entry of the base serial number and provide access to the Service Mode of an IDNet scale.

#### 3.5.2.3.1. Base Serial Number

If appropriate, enter the connected scale base serial number in this field. An entry of up to 14 characters is possible.

#### 3.5.2.3.2. Service Mode **Service Mode** (Softkey 5)

This screen displays a single box that shows messages from the IDNet base up to 16 characters. When either the  (Yes) or  (No) softkey is pressed, the terminal sends the respective response to the scale base and the next message to be displayed is transmitted back to the terminal from the base. This sequence remains constant during the complete service mode communication sequence.

After the last communication from the scale base has been completed, the display returns to the Calibration screen.

### 3.5.2.4. Zero

This section provides access to Auto Zero Maintenance (AZM) settings, power-up zero, and timed zero parameters.

#### 3.5.2.4.1. AZM & Display

AZM (Automatic Zero Maintenance) is a means of tracking zero when the scale is empty. AZM compensates for conditions such as terminal or load cell drift or slow debris buildup on a scale platform.

##### **Auto Zero**

Use the Auto Zero parameter to select the auto zero maintenance parameter. The choices include:

Disabled, **Enabled [default]**

##### **Power Up**

This step determines if at power up, the terminal will restart with the most recent zero reference point it had before power down or if it will reset to the calibrated zero reference. A Power Up setting of Restart enables the terminal to reuse the most recent zero reference weight after a power cycle so it returns to the same, previously displayed gross weight value. If reset is selected, the last zero calibration value will be used as the zero reference point. The choices are:

Reset, **Restart [default]**

##### **Timed Zero**

When enabled, the Timed Zero function monitors the weighing system to ensure that the system sees the center of zero condition at stability within a certain pre-determined time or the scale is disabled. The following choices are available for enabling the Timed Zero function:

**Disabled [default]**, 10 minutes, 15 minutes, 30 minutes

It is strongly recommended to leave Timed Zero disabled (default condition) unless the application/installation requires MID R51 approval for automatic catchweighing equipment.

#### 3.5.2.4.2. Ranges

Use the settings on the Ranges screen to enable or disable the Pushbutton Zero function.

##### **Pushbutton Zero**

If Pushbutton Zero is enabled, the keypad ZERO pushbutton will operate to capture new zero reference points. The choices for pushbutton zero are:

Disabled, **Enabled [default]**

If Pushbutton Zero is Disabled, execution of a remote zero is still possible via SICS, CPTZ, SMA commands from a PC, a discrete input or from PLC commands. To set the zero range for these remote zero functions, first enable the Pushbutton Zero, select the pushbutton zero range and then disable the Pushbutton Zero.

#### 3.5.2.5. Tare

Tare is used to subtract the weight of an empty container from the gross weight on the scale to determine the net weight of the contents. Tare is inhibited if the scale is in motion. This branch provides access to program the tare types, auto tare and auto clear tare parameters.



### 3.5.2.5.1. Tare Types

Use the Tare Types setup screen to enable or disable pushbutton tare, keyboard tare, net sign correction.

#### Pushbutton Tare

When pushbutton tare is enabled, the front panel tare key  can be pressed when an empty container is on the scale to determine tare. The terminal displays a zero weight and net mode. When the container is loaded and placed back on the scale, the terminal displays the net weight of the contents. The selections include:

Disabled, **Enabled** [default]

If Pushbutton Tare is Disabled, execution of a remote Tare is still possible via SICS, CPTZ, and SMA commands from a PC, a discrete input, or using PLC commands.

#### Keyboard Tare

When keyboard tare is enabled, the known value for the empty weight of a container (tare) can be entered manually (preset tare). The terminal will then display the net weight of the contents of the container. Keyboard tares are automatically rounded to the closest display division. Choices are:

Disabled, **Enabled** [default]

#### Net Sign Correction

Net sign correction enables the IND570 terminal to be used for both shipping (inbound empty) and receiving (inbound loaded) operations. If net sign correction is enabled, the terminal will switch the gross and tare weight fields on the printed ticket, if necessary, so that the larger weight is the gross weight, the smaller weight is the tare weight, and the difference is always a positive net weight. Net sign correction affects the printed data output, the recalled weight display and the displayed weight. Continuous data output will continue to show a negative net weight value. The choices for Net Sign Correction are:

**Disabled** [default], Enabled

Net sign correction will operate with pushbutton tare, preset tare, or tare records stored in the Tare Table. An example of weight values with and without net sign correction is shown in Table 3-1. In this example, the tare register value is 53 kg and the live weight on the scale is 16 kg.

**Table 3-2: Weight Values With and Without Net Sign Correction**

Printed and Displayed	Net Sign Correction	
	Disabled	Enabled
Gross	16 kg	53 kg
Tare	53 kg	16 kg
Net	- 37 kg	37 kg

- When net sign correction is enabled, the tare weight field in the recall display will be labeled with the letter "M" to indicate "Memory" instead of "T" or "PT".

### Terminal Tare

When Terminal Tare is Disabled, all Tare commands received by the IND570 via SICS, CTPZ, PLC or keypad will be passed through to the IDNet base for execution. The base will calculate the tare and net weight values and pass this information back to the IND570. When Terminal Tare is enabled, tare and net weight values are calculated in the terminal and not in the high precision IDNet base. The selections include:

**Disabled** [default], Enabled

When Terminal Tare is Enabled, the stability timeout value will be set to 3 seconds (default), but can be set to any value between 0 and 99 in the setup menu at **Scale > Stability**. A value of "99" instructs the terminal to wait indefinitely for a stable condition – a Tare command would never be aborted due to motion.

When Terminal Tare is Disabled, the stability timeout value defaults to "99", and cannot be modified. The terminal will not display or transmit Net status, Net weight or Tare weight until it receives this information from the scale base. Only when the IDNet base responds will the terminal display and transmit the tare value and Net status to the PC/PLC.

Terminal Tare should be Disabled for approved (legal-for-trade) systems.

#### 3.5.2.5.2. Auto Tare

Use the Auto Tare screen to enable or disable automatic tare and to set the tare and reset threshold weights, and enable or disable motion check.

### Auto Tare

When auto tare is enabled, the tare weight is taken automatically when a container above the threshold weight is on the scale and settles to no-motion. Selections are:

**Disabled** [default], Enabled

### Tare Threshold Weight

When weight on the scale platform exceeds the programmed tare threshold value and settles to no-motion, the terminal automatically tares.

### Reset Threshold Weight

The reset threshold weight must be less than the tare threshold weight. When the weight on the scale platform falls below the reset threshold value, such as when a load has been removed, the terminal automatically resets the auto tare trigger, depending upon the programming of motion checking.

### Motion Check

When enabled, the scale must detect a non-motion condition below the reset value to reset the auto tare trigger. The choices are:

Disabled, **Enabled** [default]

#### 3.5.2.5.3. Auto Clear

Use the Auto Clear screen to program auto clear tare, clear after print, to set the clear threshold weight, and enable or disable motion checking for auto clearing of tare.

##### **Auto Clear Tare**

To clear tare automatically when the scale returns to below the threshold weight, enable the auto clear tare setting. Selections include:

**Disabled** [default], Enabled

##### **Clear Threshold Weight**

The Clear Threshold Weight parameter is shown only when Auto Clear Tare is enabled. When the gross scale weight exceeds then falls below the programmed clear threshold weight value, the terminal automatically clears tare and returns to gross mode.

##### **Motion Check**

The Motion Check field displays only when Auto Clear Tare is enabled. Enable the motion check setting to prevent auto clear from occurring when the scale is in motion. The choices are:

Disabled, **Enabled** [default]

##### **Clear After Print**

To clear tare automatically after printing, enable the clear after print setting. Possible settings include:

**Disabled** [default], Enabled

##### **Clear With Zero**

To clear tare automatically when capturing zero from the net mode, enable the clear with zero setting. Choices are:

**Disabled** [default], Enabled

##### **Power Up**

A Power Up setting of Restart enables the terminal to reuse the last tare weight after a power cycle. If Reset is selected, the terminal returns to gross mode upon power up and the last tare weight after the power cycle is cleared. Selections are:

**Restart** [default], Reset

#### **3.5.2.6. Units**

This setup screen enables the selection of a second and a third unit and determines which unit is used at power up. If printing of two units is required, establish Third Units. Both Primary and Third units can be printed simultaneously in an output template.

##### 3.5.2.6.1. Second Unit

Use the Second Unit selection box to select a second weighing unit. Only one custom unit is possible.

Available weighing units include:

**None** [default], Custom, pennyweight (dwt), grams (g), kilograms (kg), pounds (lb), pounds-ounces (lb-oz), ounces (oz), troy ounces (ozt), tonnes (t), tons (ton)

#### 3.5.2.6.2. Third Unit

Use the Third Unit selection box to select a third weighing unit. Possible weighing units are:

**None** [default], Custom, pennyweight (dwt), grams (g), kilograms (kg), pounds (lb), pounds-ounces (lb-oz), ounces (oz), troy ounces (ozt), tonnes (t), tons (ton)

#### 3.5.2.6.3. Power Up

Power up units defines the units the terminal defaults to after power up.

**Primary Units** The terminal restarts in primary units

**Restart** [default] The terminal restarts with whichever units were last displayed before the power cycle.

#### 3.5.2.6.4. Custom Factor

This parameter is shown only if a Custom unit is selected. Enter a multiplication factor for the custom unit in this field, such as 0.592 or 1.019. The primary unit is multiplied by the custom factor to obtain the custom value.

#### 3.5.2.6.5. Custom Name

This parameter is shown only if a Custom unit is selected. Use the alpha keys to enter the name for the custom unit. Up to 12 characters may be entered. The terminal displays the first three letters of the custom name in the units area of the display when custom units are in use.

#### 3.5.2.6.6. Custom Increment

This parameter is shown only if a Custom unit is selected. Enter a custom increment in this field, such as 0.1 or 0.5. This step controls both the decimal position and the increment size of the custom unit value.

### 3.5.2.7. Rate

A Rate, expressed as change in primary or secondary weight units per time unit, may be programmed for display on the IND570 and/or used in controlling discrete outputs – for example as the source for a Comparator (refer to section 3.6.2.2.1, and the **Comparators: Configuration and Operation** section of Chapter 4, **Applications**, for more details).

- The Rate display is selectable for display in the auxiliary display area below the weight display. Refer to section 3.7.2.4, **Terminal I Display I Auxiliary Display**, for more information on using the auxiliary display.

If the weight information in the terminal becomes invalid, the Rate display will show 0.000. The following Rate parameters can be configured:

#### 3.5.2.7.1. Weight Units

Weight Units define which weight unit will be used for the rate calculation.

<b>None</b> [default]	Rate function is disabled
Primary	Primary weight units are used
Secondary	Secondary weight units are used. A secondary unit must be enabled for this choice to be shown.

3.5.2.7.2. Time Units

Time Units determine what time reference will be used for the rate value. Choices include:

**Seconds** [default], Minutes, Hours

3.5.2.7.3. Measurement Period

The Measurement Period value sets the frequency of weight measurements. Choices are:

0.5 seconds, **1 second** [default], 5 seconds

3.5.2.7.4. Output Average

Output from the rate function is set by a computed rolling average of measurements. This possible range of values is 1 to 99 seconds, with a default value of **5**. The Output Average value should be sufficiently larger than the Measurement Period to allow the terminal to take multiple measurements for each average.

**3.5.2.8. Filter**

The IDNet version IND570 terminal provides choices for vibration and the type of weighing process. This screen is not accessible when Remote is selected as the scale type. From Rev 03 3.5.8

3.5.2.8.1. Vibration

Use the Vibration selection box to select a condition setting that reflects the platform's specific location's conditions. This setting is then sent to the load cell and stored there. Selections include:

Ideal Conditions	The weighing platform operates very quickly. However, it is very sensitive. This setting is suitable for a very calm and stable weighing location.
<b>Average Conditions</b> [default]	This is the factory default setting and is suitable for most normal environments.
Extreme Conditions	The base reacts to changes in weight more slowly but is much more stable in unstable environments.

3.5.2.8.2. Weighing Process

Use the Weighing Process selection box to select the specific weighing process in use on the platform. This setting is then sent to the load cell and stored there. Selections include:

Fine Filling	Used when liquid or fine powders are being weighed
<b>Universal Weighing</b> [default]	For solid materials coarse filling or checkweighing
Static Weighing	For solid materials and weighing under extreme conditions such as strong vibrations

Dynamic Weighing	For weighing products that will not be fully stable or still during the weighing process
------------------	--

### 3.5.2.9. Stability

For IDNet bases, a stability measure and timeout period may be set.

#### 3.5.2.9.1. Stability

Stability settings for IDNet load cells are configured by selecting a number setting of 0 (disabled), 1 (fast display, good repeatability), 2 (slower display, better repeatability), 3 (slower display, better repeatability), or 4 (very slow display, very good repeatability) in the Stability selection box.

#### 3.5.2.9.2. Timeout

Defines the period (in seconds) after which the terminal stops attempting to perform a function that requires a no-motion condition (such as a zero, tare or print command) and aborts the function. This timeout is used regardless of the source of the command such as the keypad, discrete input, PLC or SICS. Values from 0 to 99 are possible with the default value being **3** seconds. A smaller value means that less time will be used to check for no-motion before aborting a command. When a value of 0 is entered, there must be no-motion when a command is given or it will fail immediately. A value of 99 is a special condition which permits the terminal to wait indefinitely for a no-motion condition - a command would never be aborted.

### 3.5.2.10. Log or Print

The Log or Print setup branch is where the thresholds to control how and when a demand data output is triggered. Normal demand mode printing occurs whenever a print request is made, providing there is no motion on the scale and the weight is above gross zero (a negative gross weight will not be printed).

The weight values entered are the gross weight values in primary units. Gross weight in primary units is used regardless of whether the IND570 is in Gross or Net mode and regardless of the units that are displayed.

#### 3.5.2.10.1. Minimum Weight

The minimum weight setting is the threshold below which log or print functions will not initiate. Primary units are displayed for this field. Enter the required value in primary weight units.

#### 3.5.2.10.2. Interlock

Interlock prevents repeat logging and printing. When enabled, this interlock requires that the live weight reading be reset according to the **Reset On** parameter setting (see below). The live weight must then settle to a weight greater than the Minimum Weight value (see above) before responding to the next log or print request. Choices are:

**Disabled** [default], Enabled

#### 3.5.2.10.3. Automatic

This parameter triggers an automatic log and print request every time the weight on the scale settles to a positive value that is larger than the entered Threshold Weight value (see below). After the initial log or print, the automatic trigger must reset per the Reset On parameter setting (see below) before the next automatic log and print can occur. The possible selections for this parameter are:

**Disabled** [default], Enabled

If Automatic is set to Disabled, the Threshold Weight field does not appear.

3.5.2.10.4. Reset On

The reset of Interlock and Automatic printing or logging can be based on weight threshold or weight deviation values. Select the desired operating mode and enter the weight value in the "Reset On" field. The choices include:

Deviation	The weight must change more than this absolute value for the Interlock and Automatic print to reset
<b>Return</b> [default]	The weight must return to below this value for the Interlock and Automatic print to reset

If both Interlock and Automatic settings are disabled, the Reset On field does not display.

If Reset On is set to Deviation, The Threshold Weight and Motion Check fields do not display.

3.5.2.10.5. Threshold Weight

The Threshold Weight is the value above which an Automatic logging or printing of data can/will be triggered. Threshold Weight does not appear if Automatic is set to Disabled or if Reset On is set to Deviation.

3.5.2.10.6. Motion Check

Enable the motion check setting to prevent interlock and automatic log and print functions from resetting when the scale is in motion below the "Reset On" return point. Motion Check does not appear if Reset ON is set to Deviation. Choices are:

**Disabled** [default], Enabled

**3.5.2.11. MinWeigh**

If the current net weight is greater than or equal to the MinWeigh value, all terminal functions behave normally. If the absolute value of the net weight is less than MinWeigh, the weight display includes a flashing MinWeigh symbol  to the left of the weight. If the user attempts to record the weight while in this condition, the printout will include an asterisk (\*).

3.5.2.11.1. MinWeigh

This selects the operating mode of the MinWeigh feature. Choices include:

<b>Disabled</b> [default]	The MinWeigh feature will not operate.
Calculated	The MinWeigh feature will operate and the MinWeigh value will be calculated based on measurement values entered.
Direct Entry	The MinWeigh feature will operate and the MinWeigh value will be directly entered by hand.

3.5.2.11.2. Calculated Mode

When **Calculated** is selected, the user is prompted to enter the uncertainty  $U_0$ , c factor, tolerance percent, and safety factor in data entry boxes. The new MinWeigh value is then computed using these values. The MinWeigh value can be viewed but not directly edited in this mode. Where:

Uncertainty $U_0$	Uncertainty in measurement as the applied load approaches 0. $U_0$ is computed differently in each country and is entered in Primary units of measure.
Uncertainty c	Uncertainty factor related to the portion of uncertainty in measurement that is proportional to the applied load.
Tolerance	Tolerance in percent, which reflects the tolerances required for the specific process and facility. The range is 0.1%–99.9%.
Safety Factor	To calculate the minimum weight the safety factor is usually $SF = 1$ . However, if the customer would like to recalculate this number for purposes of more closely matching a GWP Recommendation this value will generally be specified by the customer starting at 2. The integer value range is 1–10 and is used to determine the exclusion range.

3.5.2.11.3. Direct Entry Mode

For **Direct Entry** of a MinWeigh value, user enters the desired value for MinWeigh directly in the MinWeigh data entry box. The MinWeigh value is entered in Primary units of measure.

**3.5.2.12. Reset**

Refer to section 3.5.6 on page 3-68.

**3.5.3. Scale – SICSpro**

Metrological and some environmental parameters are accessed and stored in the load cell for the SICSpro interface. So, the Scale branch has a reduced set of parameters. Access to the setup in the SICSpro load cell is called the Advanced Setup Mode and is accessible from a branch in the Scale block.

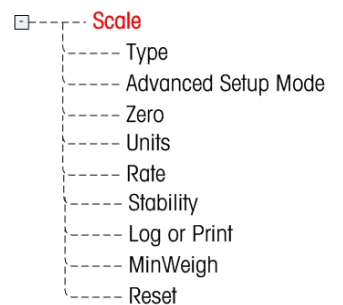

The IND570 terminal is only compatible with SICSpro platforms that include ASM.

Refer to Chapter 1, **Introduction**, for a list of compatible SICSpro platforms.

**3.5.3.1. Type**

The Scale Type screen permits a name to be assigned to the scale, displays the scale PCB type in the terminal (or allows the IND570 to be configured as a remote display for another terminal), provides a view of the Approval mode, approval class and interval for the metrology line. The EXIT softkey will return the display to the menu tree.

3.5.3.1.1. Name

The Name field enables entry of the scale identification. Enter the scale name (an alpha-numeric string of up to 20 characters) in the Name entry box.

3.5.3.1.2. Scale Type

The Scale Type field indicates which type of scale this terminal supports and allows selection of Remote Display mode. Choices are:

SICSpro [default], Remote





Refer to Chapter 4, **Applications**, for specific instructions on configuring the terminal for use as a remote display.

### SICSpro Cable-Free Floor Scale



**Figure 3-8: IND570 with Bluetooth Module**

If a Bluetooth module is connected to the terminal's SICSpro scale port, a Bluetooth softkey  will appear in the fourth softkey position of the **Scale Type** screen. Press this softkey to access the Bluetooth screen. If a Cable-Free Floor Scale (CFS) is already paired with terminal, its MAC address will be displayed. A SCAN softkey  will appear in the third softkey position. The SCAN softkey is used to search for available CFS scales. Pressing it will display a "Waiting" message, and then open the BLUETOOTH VIEW screen. When the list of scales is displayed, a connected scale's MAC address will appear with an exclamation mark (!) after it. Any CFS listed with an asterisk (\*) after its name is in its fast pairing wait state, and can be selected for pairing. Select the CFS to pair then click OK.

### Bluetooth Information Recall

For details about the information available in the System Information Recall screens accessible from the home screen, refer to Chapter 2, **Operation**, section 2.9.3.

#### 3.5.3.1.3. Platform Serial Number

The platform serial number is shown as entered in the Advanced Setup Mode (ASM) of the load cell.

#### 3.5.3.1.4. Approval

The approval region of the system as programmed in the ASM of the load cell is shown. This information is included in the data shown in the metrological line at the top of the display.

- A SICSpro Cable-Free Floor Scale has the same approval options as any connected SICSpro scale.

#### 3.5.3.1.5. Class

Class is shown if the base has been programmed as Approved. This is a display-only value as programmed in the ASM of the load cell. This information is included in the data shown in the metrological line at the top of the display.

3.5.3.1.6. Verified Interval

This parameter is shown only when the scale is Approved and Class has been selected as II. The Verified Interval is programmed in the ASM of the load cell and indicates if the approved increment size is equal to the displayed increment size or if it is 10 times the displayed increment size. This information is included in the data shown in the metrological line at the top of the display.

**3.5.3.2. Advanced Setup Mode**

The Advanced Setup Mode provides access to program settings in the load cell. Refer to the manual of the SICSpro platform being connected for details of the setup steps included in ASM. Figure 3-9 provides an overview of the current ASM menu structure.

- The ASM menu can only display in English.

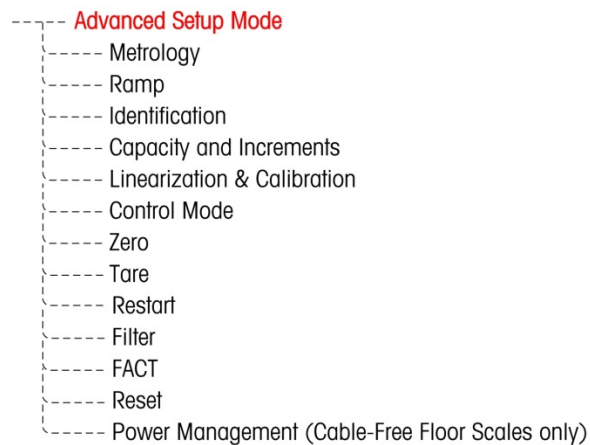

**Figure 3-9: Advance Setup Mode Basic Menu Structure**

**3.5.3.3. Zero**

This section provides access to Timed Zero settings.

3.5.3.3.1. Timed Zero

When enabled, the Timed Zero function monitors the weighing system to ensure that the system sees the center of zero condition at stability within a certain pre-determined time or the scale is disabled. The following choices are available for enabling the Timed Zero function:

**Disabled** [default], 10 minutes, 15 minutes, 30 minutes

It is strongly recommended to leave Timed Zero disabled (default condition) unless the application/installation requires MID R51 approval for automatic catchweighing equipment.

**3.5.3.4. Units**

This setup screen enables the selection of a second and a third unit and determines which unit is used at power up. If printing of two units is required, establish Third Units. Both Primary and Third units can be printed simultaneously in an output template.

#### 3.5.3.4.1.

##### Second Unit

Use the Second Unit selection box to select a second weighing unit. Only one custom unit is possible.

Available weighing units include:

**None** [default], Custom, pennyweight (dwt), grams (g), kilograms (kg), pounds (lb), pounds-ounces (lb-oz), ounces (oz), troy ounces (ozt), tonnes (t), tons (ton)

#### 3.5.3.4.2.

##### Third Unit

Use the Third Unit selection box to select a third weighing unit. Possible weighing units are:

**None** [default], Custom, pennyweight (dwt), grams (g), kilograms (kg), pounds (lb), pounds-ounces (lb-oz), ounces (oz), troy ounces (ozt), tonnes (t), tons (ton)

#### 3.5.3.4.3.

##### Power Up

Power up units defines the units the terminal defaults to after power up.

**Primary Units**      The terminal restarts in primary units

**Restart** [default]      The terminal restarts with whichever units were last displayed before the power cycle

#### 3.5.3.4.4.

##### Custom Factor

This parameter is shown only if a Custom unit is selected. Enter a multiplication factor for the custom unit in this field, such as 0.592 or 1.019. The primary unit is multiplied by the custom factor to obtain the custom value.

#### 3.5.3.4.5.

##### Custom Name

This parameter is shown only if a Custom unit is selected. Use the alpha keys to enter the name for the custom unit. Up to 12 characters may be entered. The terminal displays the first three letters of the custom name in the units area of the display when custom units are in use.

#### 3.5.3.4.6.

##### Custom Increment

This parameter is shown only if a Custom unit is selected. Enter a custom increment in this field, such as 0.1 or 0.5. This step controls both the decimal position and the increment size of the custom unit value.

### 3.5.3.5.

#### Rate

A Rate, expressed as change in primary or secondary weight units per time unit, may be programmed for display on the IND570 and/or used in controlling discrete outputs – for example as the source for a Comparator (refer to section 3.6.2.2.1, and the **Comparators: Configuration and Operation** section of Chapter 4, **Applications**, for more details).

- The Rate display is selectable for display in the auxiliary display area below the weight display. Refer to section 3.7.2.4, **Terminal I Display I Auxiliary Display**, for more information on using the auxiliary display.

If the weight information in the terminal becomes invalid, the Rate display will show 0.000. The following Rate parameters can be configured:

#### 3.5.3.5.1.

##### Weight Units

Weight Units define which weight unit will be used for the rate calculation.

<b>None</b> [default]	Rate function is disabled
Primary	Primary weight units are used
Secondary	Secondary weight units are used. A secondary unit must be enabled for this choice to be shown.

#### 3.5.3.5.2.

##### Time Units

Time Units determine what time reference will be used for the rate value. Choices include:

**Seconds** [default], Minutes, Hours

#### 3.5.3.5.3.

##### Measurement Period

The Measurement Period value sets the frequency of weight measurements. Choices are:

0.5 seconds, **1 second** [default], 5 seconds

#### 3.5.3.5.4.

##### Output Average

Output from the rate function is set by a computed rolling average of measurements. This possible range of values is 1 to 99 seconds, with a default value of 5. The Output Average value should be sufficiently larger than the Measurement Period to allow the terminal to take multiple measurements for each average.

#### 3.5.3.6.

##### Stability

For SICSpro bases, a timeout period may be set.

#### 3.5.3.6.1.

##### Timeout

Defines the period (in seconds) after which the terminal stops attempting to perform a function that requires a no-motion condition (such as a zero, tare or print command) and aborts the function. This timeout is used regardless of the source of the command such as the keypad, discrete input, PLC or SICS. Values from 0 to 99 are possible with the default value being 3 seconds. A smaller value means that less time will be used to check for no-motion before aborting a command. When a value of 0 is entered, there must be no-motion when a command is given or it will fail immediately. A value of 99 is a special condition which permits the terminal to wait indefinitely for a no-motion condition - a command would never be aborted.

#### 3.5.3.7.

##### Log or Print

The Log or Print setup branch is where the thresholds to control how and when a demand data output is triggered. Normal demand mode printing occurs whenever a print request is made, providing there is no motion on the scale and the weight is above gross zero (a negative gross weight will not be printed).

The weight values entered are the gross weight values in primary units. Gross weight in primary units is used regardless of whether the IND570 is in Gross or Net mode and regardless of the units that are displayed.

3.5.3.7.1. Minimum Weight

The minimum weight setting is the threshold below which log or print functions will not initiate. Primary units are displayed for this field. Enter the required value in primary weight units.

3.5.3.7.2. Interlock

Interlock prevents repeat logging and printing. When enabled, this interlock requires that the live weight reading be reset according to the **Reset On** parameter setting (see below). The live weight must then settle to a weight greater than the Minimum Weight value (see above) before responding to the next log or print request. Choices are:

**Disabled** [default], Enabled

3.5.3.7.3. Automatic

This parameter triggers an automatic log and print request every time the weight on the scale settles to a positive value that is larger than the entered Threshold Weight value (see below). After the initial log or print, the automatic trigger must reset per the Reset On parameter setting (see below) before the next automatic log and print can occur. The possible selections for this parameter are:

**Disabled** [default], Enabled

If Automatic is set to Disabled, the Threshold Weight field does not appear.

3.5.3.7.4. Reset On

The reset of Interlock and Automatic printing or logging can be based on weight threshold or weight deviation values. Select the desired operating mode and enter the weight value in the "Reset On" field. The choices include:

**Deviation**            The weight must change more than this absolute value for the Interlock and Automatic print to reset

**Return** [default]    The weight must return to below this value for the Interlock and Automatic print to reset

If both Interlock and Automatic settings are disabled, the Reset On field does not display.

If Reset On is set to Deviation, The Threshold Weight and Motion Check fields do not display.

3.5.3.7.5. Threshold Weight

The Threshold Weight is the value above which an Automatic logging or printing of data can/will be triggered. Threshold Weight does not appear if Automatic is set to Disabled or if Reset On is set to Deviation.

3.5.3.7.6. Motion Check

Enable the motion check setting to prevent interlock and automatic log and print functions from resetting when the scale is in motion below the "Reset On" return point. Motion Check does not appear if Reset ON is set to Deviation. Choices are:

Disabled [default], Enabled

**3.5.3.8. MinWeigh**

If the current net weight is greater than or equal to the MinWeigh value, all terminal functions behave normally. If the absolute value of the net weight is less than MinWeigh, the weight display includes a flashing MinWeigh symbol **⚠** to the left of the weight. If the user attempts to record the weight while in this condition, the printout will include an asterisk (\*).

3.5.3.8.1. MinWeigh

This selects the operating mode of the MinWeigh feature. Choices include:

- Disabled** [default]    The MinWeigh feature will not operate.
- Calculated              The MinWeigh feature will operate and the MinWeigh value will be calculated based on measurement values entered.
- Direct Entry            The MinWeigh feature will operate and the MinWeigh value will be directly entered by hand.

3.5.3.8.2. Calculated Mode

When **Calculated** is selected, the user is prompted to enter the uncertainty  $U_0$ , c factor, tolerance percent, and safety factor in data entry boxes. The new MinWeigh value is then computed using these values. The MinWeigh value can be viewed but not directly edited in this mode. Where:

- Uncertainty  $U_0$         Uncertainty in measurement as the applied load approaches 0.  $U_0$  is computed differently in each country and is entered in Primary units of measure.
- Uncertainty c            Uncertainty factor related to the portion of uncertainty in measurement that is proportional to the applied load.
- Tolerance                Tolerance in percent, which reflects the tolerances required for the specific process and facility. The range is 0.1%–99.9%.
- Safety Factor            To calculate the minimum weight the safety factor is usually  $SF = 1$ . However, if the customer would like to recalculate this number for purposes of more closely matching a GWP Recommendation this value will generally be specified by the customer starting at 2. The integer value range is 1–10 and is used to determine the exclusion range.

3.5.3.8.3. Direct Entry Mode

For **Direct Entry** of a MinWeigh value, user enters the desired value for MinWeigh directly in the MinWeigh data entry box. The MinWeigh value is entered in Primary units of measure.

**3.5.3.9. Reset**

Refer to section 3.5.6 on page 3-68.

### 3.5.4. Scale – POWERCELL

#### 3.5.4.1. Type

The Scale Type screen permits a name to be assigned to the scale, displays the scale PCB type in the terminal (or allows the IND570 to be configured as a remote display for another terminal), provides a selection list for the Approval mode, and allows entry of the approval class and interval for the metrology line. The EXIT softkey  will return the display to the menu tree.

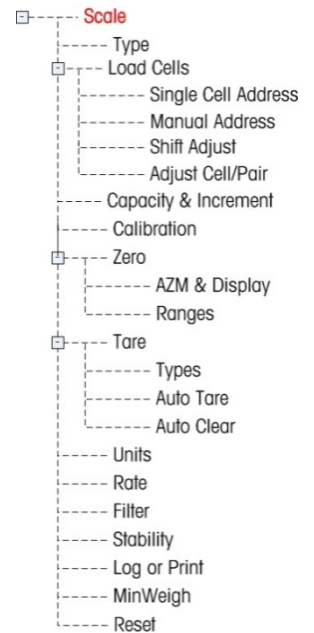

##### 3.5.4.1.1. Name

The Name field enables entry of the scale identification. Enter the scale name (an alpha-numeric string of up to 20 characters) in the Name entry box.

##### 3.5.4.1.2. Scale Type

The Scale Type field indicates which type of scale this terminal supports and allows selection of Remote Display mode. If Remote is selected, the approval, class and verified interval options will not be available. Choices are:

**POWERCELL** [default for POWERCELL version], Remote

Refer to Chapter 4, **Applications**, for specific instructions on configuring the terminal for use as a remote display.

#### Application

The application field identifies in what type of application the terminal will be used. Depending upon this choice, some parameters may be not available for programming. Choices are:

**Vehicle** [default], Tank/Hopper, Floor Scale

#### Approval

Approval refers to the metrological (weights and measures) approval configuration for the specific scale. The selection list includes:

**None** [default], USA, OIML, Canada, Australia, Argentina, Thailand, Korea

If the approval is configured as USA, OIML, Canada, Australia, Thailand or Korea and the metrology security switch, SW1-1, is set to ON, access to the Scale setup parameters in the menu tree will be limited to view only.

If the approval is configured as Argentina and the metrology security switch, SW1-1, is set to ON, access to the entire setup menu is prohibited. If an attempt is made to access the setup menu, an on-screen message will display stating "Access denied. Scale is Approved."

If an approval is selected but SW1-1 is not ON, it will not be possible to leave setup, and a message will appear: "Switch UNSECURED".

**# of Load Cells**

Enter the quantity of POWERCELL load cells in the scale network. Values from 1 to 14 are valid. The default value is **8**.

**Class**

The Class field selection is shown if a POWERCELL scale terminal is selected as approved. This selection must match the Weights and Measures approval class when the terminal is used in an approved mode. The Class information is included in the data shown in the metrological line at the top of the display. The selections are:

II, III [default], III HD, III L, IIII

**Verified Interval**

This parameter is shown only when the terminal has been programmed as Approved and Class has been selected as II. The Verified Interval indicates if the approved increment size is equal to the displayed increment size or if it is 10 times the displayed increment size. This information is included in the data shown in the metrological line at the top of the display.

**e=d** [default], e=10d

**Update Rate**

The update rate field determines how fast the POWERCELL network polls the load cells for weight data. This value will be limited based on the number of load cells in the network as shown in Table 3-3. Choices include **15** [default], 25, 40 or 50.

**Table 3-3: Update Rate Selections**

Quantity of Cells	Possible Update Rates
1 - 6	15, 25, 40, 50
7 - 10	15, 25, 40
11 - 14	15, 25

This value also determines the speed of the target control when using the material transfer mode.

**3.5.4.2.**

**Load Cells**

This branch is used to address the POWERCELL load cells and perform a shift adjustment. There are two different methods provided to address the load cells. Refer to Table 3-4 as a guide as to which one to use.

**Table 3-4: Addressing Method**

Cell Address Method	Description
Single Cell Addressing	This procedure would typically be used during the replacement of a cell, off-site testing or pre-installation when there is only one cell connected in the network. It could also be used to discover a single connected cell's serial number and node address. During an actual on-site installation when many load cells are already connected in the network, or when



Cell Address Method	Description
	installing a new scale, the Manual procedure should be used.
Manual Address	Typically, this procedure is used when installing a new scale with load cells that have the factory default node address. The serial number and location of each cell must be known.

### 3.5.4.2.1. Single Cell Address

Single cell addressing can be performed manually or automatically at power-up, as required. In either case, the procedure cannot be performed if the terminal is in Weights and Measures Approved mode.



#### Single Cell Address – Manual

Use the Single Cell Address step to set the node address of a load cell identified by its serial number. This procedure would typically be used during the replacement of a cell. It can be used with just one cell connected or with an entire network connected.

Follow this procedure to perform a single cell address:

1. The initial screen prompts for the connection of the load cell.
2. Make sure the cell that needs to be addressed is connected and press the START softkey  to begin the process. The display indicates that load cell discovery process has begun, and a message appears briefly:



*/Discovering cells/*

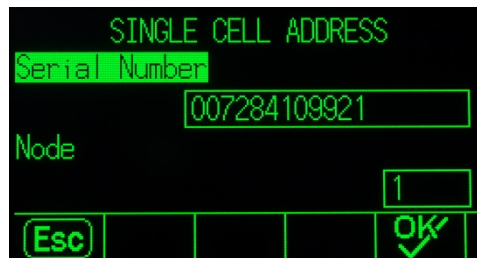

The addressing operation can be aborted by pressing the ABORT  softkey during the discovery process. The EXIT  softkey will then take you back to the setup menu tree.

3. After the first load cell is detected, that cell's serial number and current node address are displayed as shown in Figure 3-10. If no cell is found the display will indicate Search Failed.



**Figure 3-10: Single Cell Address Discovery Display**

4. If more than one load cell is connected in the network when this discovery process is executed, the terminal will display the serial number and node address of the first cell it discovers. Before reassigning the node address of the cell that was found, make sure that the serial number matches that of the cell to be addressed. If it is not the desired cell, then identify the one to be addressed by entering its serial number.
5. To quit the addressing process or return to the Single Cell Address Start screen, press the ESCAPE softkey . Otherwise, enter the required address in the Node entry box and press the OK softkey  to start the addressing process.

6. The display indicates that addressing is in progress by briefly displaying a message of **Addressing Load Cell**.
7. After the load cell has been successfully assigned a new address, a message of **Addressing Completed** will be shown.
8. Press the EXIT softkey  to return to the Single Cell Address Start screen.
9. Repeat these steps to address another cell, or press the EXIT softkey  to return to the setup menu tree.

#### Single Cell Address – Automatic

This automatic feature, which checks the load cell network on start-up, is available for all types and sizes of POWERCELL network. If a load cell is found to be missing – i.e., it has stopped communicating – the terminal searches the network for a cell with the factory default node address.

If the default address is not found, the procedure is aborted and the terminal continues with its power-up sequence. In this case, the replacement cell must be addressed manually, as described immediately above.

If a cell is found with the default address, the terminal prompts **Replace POWERCELL *n* with new POWERCELL?**, where *n* is the node number.

Answer **Yes** to perform the addressing procedure, which assumes the new cell should have the same node number as the missing cell. The replacement cell uses all the existing operating parameters of the previous cell.

An on-screen progress display indicates that addressing is taking place. Once it is complete, the system adds a maintenance log entry indicating the change, and continues with its normal power-up sequence.



#### 3.5.4.2.2. Manual Address

Use the Manual Address step to program the node address of every load cell connected in a network. Typically, this procedure is used when installing a new scale with load cells that have the factory default node address of 125. To address the cells manually, follow this procedure:

1. Before starting the addressing process, record the serial number of each cell and where each cell is arranged on the scale. Determine which node address should be assigned to each of the cells.
2. The initial screen displays a message indicating that the process will take several minutes.
3. Make sure all the cells are connected to the network and press the START softkey  to begin the process.

The display will indicate that the process has started by display a message of **/Discovering cells/**



During the discovery process, the display will indicate how many cells have been discovered. The discovery process will continue even after the programmed number of cells has been discovered to make sure "extra" cells are not connected.

The addressing operation can be aborted by pressing the ABORT  softkey during the discovery process. The EXIT  softkey will then take you back to the setup menu tree.

- During the procedure, the terminal will automatically assign a unique node address to each of the cells discovered. The addresses are assigned arbitrarily by the terminal. After the process is complete, a Load Cell View table is displayed, indicating the serial number and node address for each cell (Figure 3-11).

Node	Serial Number
1	007284382459
2	007284424858
3	007284132651
4	007279180353
5	007204121200

**Figure 3-11: Manual Address Load Cell View Screen**

- Review the list of serial numbers and location created in Step 1. If the node address preset by the terminal is not appropriate for a particular serial number, select the serial number and press the EDIT softkey .
- After pressing the EDIT softkey , the Load Cell Edit screen will appear as shown in Figure 3-12.





LOAD CELL EDIT



Serial Number  
007284109921

Node  
1

[Esc] [OK]

**Figure 3-12: Manual Address Load Cell Edit Screen**

- Press the ESCAPE softkey  to return to the previous screen if no changes are required. To change the node address, enter the required address in the Node entry box, press ENTER then press the OK softkey  to start the addressing process.
- The display indicates that addressing is in progress by showing the message Addressing Load Cell.
- After the address has been successfully changed, a message of Addressing Completed is displayed.
- If the node address entered by the user is an existing address already assigned to another load cell, the terminal will complete the addressing as requested, and will reassign the original address of the selected cell to the other load cell. This resolves any potential conflicts by swapping the addresses between the cells.
- Press the EXIT softkey  to return to the Manual Address View screen.
- Repeat steps 6 – 10 to address another cell, or press the EXIT softkey  to return to the setup menu tree.
- To print the details shown on the Manual Address View screen, press the PRINT softkey  and the data will be sent to any port with a Reports connection.

- To address a newly added cell into the network, simply press the NEW softkey  from the Load Cells View screen. Enter the cell's serial number and the required node address into the entry boxes shown in the Load Cell New screen (Figure 3-13) then press the OK softkey  to complete the new cell addressing.

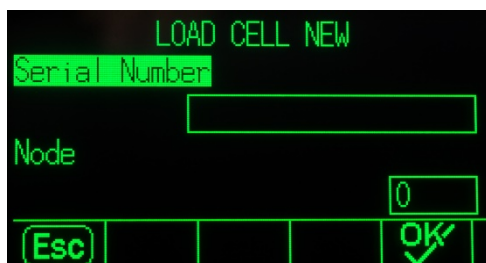

Figure 3-13: Manual Address Load Cell New Screen

#### 3.5.4.2.3. Shift Adjust

Small mismatches in mechanical and electronic gain of the load sensing paths can cause the same test weight to produce slightly different readings, depending on the location of the test weight on the scale. The IND570 provides two types of adjustment – adjustment by individual cells or adjustment by pairs of cells.

The Shift Adjust by Cell or Pair parameter is preset to Cell and cannot be changed when a single load cell is used.

##### Adjust by Cell



Adjustment by Cell adds a factor to each load cell output to compensate for the slight differences between them. The scale will then output the same weight value regardless of the physical location of the weight on the scale.

##### Adjust by Pair



Adjustment by Pair ensures a constant reading from the scale regardless of where the load is placed on the long axis between pairs of cells – for instance, in vehicle weighing applications.

Before beginning the shift adjustment procedure, select whether the adjustment will be done by cell or by pair. The procedure for shift adjusting by pair of cells is listed below. The procedure for shift adjusting by individual cell follows the same sequence, but cells are read and adjusted one at a time.

The procedure for shift adjusting by pair of cells is:

1. In the Adjust By selection list, select Pair.
2. Press the START softkey .
3. The display shows the reserved space on the first two lines for the number of counts for each cell but they are blank to start. The display shows an **Empty Scale** prompt. Empty the scale then press the START softkey .
4. The display will indicate that the initial reading is taking place by showing the message **Getting Counts**.
5. After the initial zero reading is complete, the screen will then display the counts from each of

the cells in the first pair to be adjusted. Follow the on-screen prompting of **Place test Weight on Cell 1 & 2** (or the addresses of the current cell pair being adjusted).

6. Place the test load on the platform, centered between cell 1 and cell 2 (or the addresses of the current cell pair being adjusted) then press the START softkey .
7. An on-screen message will indicate that the terminal is getting shift adjust counts. The Cell Counts lines will change to reflect the new readings from the load cells, and then the prompt will show **Place test Weight on Cell 3 & 4** (or the addresses of the next cell pair).
8. Move the test load from the previous pair of cells to the next pair keeping the load centered on the platform. Press START  to continue.
9. The Cell Count lines will change to reflect the new readings.
10. Repeat steps 6 through 9 until all cell pairs have been adjusted. An on-screen message of **Adjust OK** will then be displayed.
11. Press the EXIT softkey  to return to the setup menu tree.

#### 3.5.4.2.4.



##### Shift Adjust Cell / Pair

This procedure allows you to quickly adjust the shift values for a single pair or single cell after a cell has been replaced on the scale. A complete shift adjust (previous setup branch) is more accurate and should be used if more than one POWERCELL cell has been replaced on the scale.

The Shift Adjust Cell/Pair branch is not accessible when only a single load cell is used.

Based on the selection made in the **Shift Adjust > Shift By** parameter, the terminal allows adjustment by either Cell or Pair. The following example describes the procedure when adjusting by cell. The adjustment by pair follows the same procedure except the terminal will prompt for weight to be placed above a pair of cells instead of a single cell.

##### To adjust a specific cell (example of Cell 3)

1. The on-screen prompt shows **Empty Scale**. Press Start  to continue.
2. Select Adjust Cell 3 from the list and press the START softkey  to begin.
3. The display will indicate that the initial reading is taking place by showing the message **Getting Counts**.
4. After the initial zero reading is complete, the screen will then display the counts from the cell to be adjusted. Follow the on-screen prompting of **Place test Weight on Cell 3** (or the addresses of the current cell being adjusted). Press the START softkey .

If the last addressed cell or pair on the scale is selected for Shift Adjust, the previous cell or pair is read first prior to the selected cell or pair.

5. An on-screen message will indicate that the terminal is getting shift adjust counts. The cell counts lines will change to reflect the new reading from the load cell, and then the prompt will show **Place test Weight on Cell 4** (or the address of the next cell).
6. Move the test load from the current cell to the next prompted cell then press START  to continue.
7. The display will indicate that the cell is being read by showing the message **Getting Counts**.

8. After the process is complete, the display will show **Adjust OK**. Press the EXIT softkey  to return to the setup menu tree.

### 3.5.4.3. Capacity & Increment

Use the Capacity and Increment setup screen to select primary units, set the number of ranges or intervals, program the capacity and increments sizes, and the blanking over capacity value.

When Remote is selected as the scale type, the capacity and increment size are available. These parameters are used to determine the size of the digits used in the weight display and should be entered based on the values from the master terminal.

#### 3.5.4.3.1. Primary Units

Set the primary units from the selection box choices, which include:

grams (g), **kilograms (kg)** [default], pounds (lb), tonnes (t), tons (ton)

#### 3.5.4.3.2. # Ranges/Intervals

Select the multi-interval or multiple range mode and set the number of ranges or intervals from the selections:

1 [default], 2 intervals, 2 ranges, 3 intervals, 3 ranges

#### >I1< - Range/Interval 1 Values

Specify the capacity and then the increment size for range or interval 1.

#### >I2< - Range/Interval 2 Values

When more than one range is selected, these parameters provide entry of the capacity and then the increment size for the second range or interval.

#### >I3< - Range/Interval 3 Values

When three ranges or intervals are selected, these parameters provide entry of the capacity and then the increment size for the third range or interval.

#### 3.5.4.3.3. Blank Over Capacity

Blanking of the display is used to indicate an over-capacity condition. Set the blank over capacity for the number of display increments that the terminal is permitted to go over capacity. For example, if capacity is set at 500 kg by 0.1 kg increments and the blank over capacity setting is 5 d, the terminal can display weights up to 500.5 kg. At weights over 500.5, dashed lines will display instead of a weight and demand data output is inhibited.

### 3.5.4.4. Calibration

The Calibration screens enable entry of a geo code adjustment value, the base serial number, calibration units, and linearity adjustment. The Calibration branch is not accessible when the terminal is programmed as a Remote Display scale type.

3.5.4.4.1.

Geo Code

Enter the geo code for the appropriate geo adjustment value for the current geographical location. Geo codes are numbered 0–31. Refer to Appendix D, **Geo Codes** to find the appropriate Geo Code for the installation location.

3.5.4.4.2.

Base Serial Number

If appropriate, enter the connected scale base serial number in this field. An entry of up to 14 characters is possible.

3.5.4.4.3.

Calibration Units

Select the weight unit to be used to calibrate the scale. Calibration units are the same as the primary units selections, which include:

grams (g), **kilograms (kg)** [default], pounds (lb), tonnes (t), tons (ton)

3.5.4.4.4.

Linearity Adjustment



Select the linearity adjustment from the selection box. Selections are as follows:

- Disabled** [default]      Use only zero and one span point
- 3 point**                      Use zero, midpoint, and highpoint
- 4 point**                      Use zero, lowpoint, midpoint, and highpoint
- 5 point**                      Use zero, lowpoint, midpoint, mid-highpoint, and highpoint

3.5.4.4.5.

Calibration Softkeys



The softkeys shown on the last Calibration setup screen are used for calibration procedures.



-  Capture Zero
-  Capture Span
-  Step Calibration
- CalFree**                      CalFree

**Capture Zero**



The CAPTURE ZERO softkey  triggers an independent operation to reset the zero condition of the scale.

To capture zero





1. Press the CAPTURE ZERO softkey .
2. A message displays that directs the user to empty the scale and press the START softkey . The raw counts are displayed in a box at the lower right corner of the display.

3. Empty the scale and press the START softkey . The status of the capture zero operation displays.
  - Press the ESCAPE softkey  to abort the zero process and return the display to the previous screen.
4. When the operation is complete, a final status message displays that verifies the completion of the zero capture operation.
  - If motion is present during the zero capture process, the terminal will process the dynamic weight readings then display a warning message indicating dynamic weight values were used. This message provides choices of No and Yes to either reject or accept the dynamic weight calibration. Move focus to the desired action then press the ENTER key.
5. If the zero adjustment operation was successful, a verification message that reads "Capture Zero OK" displays. If the capture zero operation was not successful, an error message that reads "Zero Failure" displays. If the zero fails, repeat the zero capture procedures. If the zero continues to fail, contact a local METTLER TOLEDO representative for assistance.
6. Press the EXIT softkey  to return to the Calibration screen.

#### Capture Span

The CAPTURE SPAN softkey | initiates a sequence to capture span that can be performed independently of capturing zero.

#### To capture span:

1. Press the CAPTURE SPAN softkey |. The Capture Span setup screen displays.
2. Enter the weight for test load 1 and all other test loads if linearity has been enabled. Each test load value must be larger than the previously entered test load value. Press the ENTER key.
3. Prompts to "Place test load" then "Press START" are shown. The raw counts are displayed in a box at the lower right corner of the display.
4. Place test load weight 1 on the scale.
5. Press the START softkey . The status of the weight capture operation displays. When the operation is complete, a status message displays that verifies the completion of the weight capture.
  - If needed, press the ESCAPE softkey  to abort the calibration process and return the display to the previous screen.
6. After the first calibration step has completed, the menu will either display a prompt for the next calibration weight to be added (if 2, 3, or 4 test load steps are enabled by the linearity adjustment parameter) or will show a successful or failed calibration sequence.
  - If motion is present during the span capture process, the terminal will process the dynamic weight readings then display a warning message indicating dynamic weight values were used. This message provides choices of No and Yes to either reject or accept the dynamic weight calibration. Move focus to the desired action and press the ENTER key.
7. Repeat steps 4-5 for test loads 2, 3, and 4 if enabled by linearity adjustment.









8. If the capture span operation was successful, a verification message that reads "Capture Span OK" displays. If the capture span operation was not successful, an error message that reads "Calibration Failure" displays. If the calibration fails, repeat the capture span procedures. If the calibration continues to fail, contact a local METTLER TOLEDO representative for assistance.
9. Press the EXIT softkey  to return to the Calibration screen.

### Step Calibration

The STEP CALIBRATION softkey  initiates a procedure that enables a "build-up" calibration for tanks and hoppers. For step calibration, the same amount of test weight is added for each step of the calibration procedure.



To perform a step calibration

1. Press the STEP CALIBRATION softkey . The Step Calibration setup screen displays.
2. Enter the target weight for the test load (the same amount of test load weight is used in each step).
3. Press the START softkey . The Step Calibration screen displays. This screen shows an active (live) weight display (using the current span factor), the intended target weight as entered on the previous screen, and the next step for the operator "Add test weight."
4. Add test weight to the tank/hopper as prompted by the display. Each time test weight is added to the scale, the active display shows the weight.
5. When the full amount of test weight has been added, press the OK softkey . The test load is captured and span factors are saved. During the time the weight is captured and the new span factor is being calculated, the display "Add test weight" changes to "Capturing span." The display then changes to the next prompt "Remove test weight then fill to target."
6. Remove the test weight. The active display returns to zero.
7. Fill the tank/hopper with a substitute material up to near the target weight. It does not have to be the exact target weight.
8. Press the OK softkey . The target weight value recalculates to show the substitute material weight plus the initial intended target weight. The display changes to the next prompt "Add test weight."
9. Add test weight to the tank/hopper. The active display shows the weight.
10. Press the OK softkey . If the actual weight does not equal the target, a new span factor calculates and the display changes to "Capturing span." The active weight display changes to match the target weight value. The display changes to the next prompt "Remove test weight then fill to target."
11. Remove the test weight. The active display returns to the previous weight that displayed for the last test load.
12. Repeat steps 7 through 11 until an appropriate number of calibration steps have been completed for the specific application.
13. Press the EXIT softkey  at any step in the procedure to stop the step calibration process and return to the Calibration screen.

## CalFree

The CALFREE softkey **CalFree** provides access to the span calculation screen for calibration of a scale without test weights.

To perform calibration of span using CalFree

1. Press the CALFREE softkey **CalFree**. The CalFree screen displays.
2. Enter an estimated preload value in the associated field. Estimated preload is an optional entry. During calculation, the terminal tests for over capacity conditions. Estimated preload is included in this calculation if entered in this field. If the preload is unknown, leave this field blank.
  - This preload value is used only to determine overload conditions and is not used as a zero reference point. The zero reference point must be captured using the normal zero calibration procedure.
3. Press the OK softkey . The span is calculated using the parameters entered and the calibration values stored in the POWERCELL load cells.
4. If the calibration operation was successful, a verification message that reads "Calibration OK" displays. If the calibration operation was not successful, an error message that reads "Calibration Failure" displays. If the calibration fails, repeat the CalFree procedure. If the calibration continues to fail, contact a local METTLER TOLEDO representative for assistance.
5. Press the EXIT softkey  to return to the Calibration screen.

### 3.5.4.5. Zero

This section provides access to Auto Zero Maintenance (AZM) settings, under zero blanking, power-up zero, and pushbutton zero parameters.

#### 3.5.4.5.1. AZM & Display

AZM (Automatic Zero Maintenance) is a means of tracking zero when the scale is empty. AZM compensates for conditions such as terminal or load cell drift or slow debris buildup on a scale platform.

#### Auto Zero

Use the Auto Zero parameter to select the auto zero maintenance parameter. The choices include:

Disabled, **Gross** [default], Gross and Net

#### Auto Zero Range

Set the auto zero range for the number of divisions (d) around the current zero setting in which auto zero will operate. Values from 0.0 to 9.9 are possible with **3** as the default.

#### Under Zero Blanking

Blanking of the display is used to indicate an under-zero condition when the weight on the scale falls below the current zero reference. Set the under zero blanking for the number of divisions (d) that the terminal is permitted to go under zero before blanking. Values from 0 to 99 are possible with **5** as the default.

- A value of 99 disables blanking under zero and the terminal will display a weight as far under zero as possible.

### Power Up

This step determines if at power up, the terminal will restart with the most recent zero reference point it had before power down or if it will reset to the calibrated zero reference. A Power Up setting of Restart enables the terminal to reuse the most recent zero reference weight after a power cycle so it returns to the same, previously displayed gross weight value. If **Reset** is selected, the last zero calibration value will be used as the zero reference point. The choices are:

Reset, **Restart** [default]

### Timed Zero

When enabled, the Timed Zero function monitors the weighing system to ensure that the system sees the center of zero condition at stability within a certain pre-determined time or the scale is disabled. The following choices are available for enabling the Timed Zero function:

**Disabled** [default], 10 minutes, 15 minutes, 30 minutes

It is strongly recommended to leave Timed Zero disabled (default condition) unless the application/installation requires MID R51 approval for automatic catchweighing equipment.

### 3.5.4.5.2.

#### Ranges

Use the settings on the Ranges screen to enable or disable Power Up Zero capture and Pushbutton Zero and to set the ranges around the original zero condition for the scale for applying these functions.

#### Power Up Zero

If Power Up Zero is enabled, the terminal tries to capture zero upon power up and a range within which zero will be captured is shown and is programmable. If Power Up Zero is disabled, the initial zero reference at power up will revert to the most recent zero reference point or to calibrated zero based on the Power Up selection on the AZM & Display screen. The selections are:

**Disabled** [default], Enabled

#### Power Up Zero Range

If Power Up Zero is enabled, -Range and +Range fields will display for setting the range around the original calibrated zero of the scale within which Power Up Zero can be applied. The range units are percent.

For example, if the +Range setting for Power Up Zero is set at 2%, Power Up Zero will only occur when the weight reading on the scale is less than 2% of scale capacity above the original calibrated zero reference. If the -Range setting for pushbutton zero is set at 2%, Power Up Zero will only occur when the weight reading on the scale is less than 2% of scale capacity below the original calibrated zero reference.

- If Power Up Zero capture is enabled and the weight on the scale is outside of the zero capture range, weighing on the scale is disabled and the display will indicate EEE until the weight is adjusted to be within this range and zero is captured.

### Pushbutton Zero

If Pushbutton Zero is enabled, the keypad ZERO pushbutton will operate to capture new zero reference points. The choices for pushbutton zero are:

Disabled, **Enabled** [default]

If Pushbutton Zero is Disabled, execution of a remote zero is still possible via SICS, CPTZ, SMA commands from a PC, a discrete input or from PLC commands. To set the zero range for these remote zero functions, first enable the Pushbutton Zero, select the pushbutton zero range and then disable the Pushbutton Zero.

### Pushbutton Zero Range

If Pushbutton Zero is enabled, –Range and +Range fields will display for setting the range around the original calibrated zero of the scale within which Pushbutton Zero can be applied. The range units are percent.

For example, if the +Range setting for Pushbutton Zero is set at 2%, Pushbutton Zero can only be used when the weight reading on the scale is less than 2% above the original calibrated zero reference. If the –Range setting for Pushbutton Zero is set at 2%, the Pushbutton Zero can only be used when the weight reading on the scale is less than 2% below the original calibrated zero reference.

### 3.5.4.6. Tare

Tare is used to subtract the weight of an empty container from the gross weight on the scale to determine the net weight of the contents. Tare is inhibited if the scale is in motion. This branch provides access to program the tare types, auto tare and auto clear tare parameters.

#### 3.5.4.6.1. Tare Types

Use the Tare Types setup screen to enable or disable pushbutton tare, keyboard tare, and net sign correction.

### Pushbutton Tare

When pushbutton tare is enabled, the front panel tare key  can be pressed when an empty container is on the scale to determine tare. The terminal displays a zero weight and net mode. When the container is loaded and placed back on the scale, the terminal displays the net weight of the contents. The selections include:

Disabled, **Enabled** [default]

If Pushbutton Tare is Disabled, execution of a remote Tare is still possible via SICS, CPTZ, and SMA commands from a PC, a discrete input, or using PLC commands.

### Keyboard Tare

When keyboard tare is enabled, the known value for the empty weight of a container (tare) can be entered manually (preset tare). The terminal will then display the net weight of the contents of the container. Keyboard tares are automatically rounded to the closest display division. Choices are:

Disabled, **Enabled** [default]

### Net Sign Correction

Net sign correction enables the IND570 terminal to be used for both shipping (inbound empty) and receiving (inbound loaded) operations. If net sign correction is enabled, the terminal will switch the gross and tare weight fields on the printed ticket, if necessary, so that the larger weight is the gross weight, the smaller weight is the tare weight, and the difference is always a positive net weight. Net sign correction affects the printed data output, the recalled weight display and the displayed weight. Continuous data output will continue to show a negative net weight value. The choices for Net Sign Correction are:

**Disabled** [default], Enabled

Net sign correction will operate with pushbutton tare, preset tare, or tare records stored in the Tare Table. An example of weight values with and without net sign correction is shown in Table 3-5. In this example, the tare register value is 53 kg and the live weight on the scale is 16 kg.

**Table 3-5: Weight Values With and Without Net Sign Correction**

Printed and Displayed	Net Sign Correction	
	Disabled	Enabled
Gross	16 kg	53 kg
Tare	53 kg	16 kg
Net	- 37 kg	37 kg

- When net sign correction is enabled, the tare weight field in the recall display will be labeled with the letter "M" to indicate "Memory" instead of "T" or "PT".

#### 3.5.4.6.2. Auto Tare

Use the Auto Tare screen to enable or disable automatic tare and to set the tare and reset threshold weights, and enable or disable motion check.

#### Auto Tare

When auto tare is enabled, the tare weight is taken automatically when a container above the threshold weight is on the scale and settles to no-motion. Selections are:

**Disabled** [default], Enabled

#### Tare Threshold Weight

When weight on the scale platform exceeds the programmed tare threshold value and settles to no-motion, the terminal automatically tares.

#### Reset Threshold Weight

The reset threshold weight must be less than the tare threshold weight. When the weight on the scale platform falls below the reset threshold value, such as when a load has been removed, the terminal automatically resets the auto tare trigger, depending upon the programming of motion checking.

**Motion Check**

When enabled, the scale must detect a non-motion condition below the reset value to reset the auto tare trigger. The choices are:

Disabled, **Enabled** [default]

## 3.5.4.6.3.

**Auto Clear**

Use the Auto Clear screen to program auto clear tare, clear after print, to set the clear threshold weight, and enable or disable motion checking for auto clearing of tare.

**Auto Clear Tare**

To clear tare automatically when the scale returns to below the threshold weight, enable the auto clear tare setting. Selections include:

**Disabled** [default], Enabled

**Clear Threshold Weight**

The Clear Threshold Weight parameter is shown only when Auto Clear Tare is enabled. When the gross scale weight exceeds then falls below the programmed clear threshold weight value, the terminal automatically clears tare and returns to gross mode.

**Motion Check**

The Motion Check field displays only when Auto Clear Tare is enabled. Enable the motion check setting to prevent auto clear from occurring when the scale is in motion. The choices are:

Disabled, **Enabled** [default]

**Clear After Print**

To clear tare automatically after printing, enable the clear after print setting. Possible settings include:

**Disabled** [default], Enabled

**Clear With Zero**

To clear tare automatically when capturing zero from the net mode, enable the clear with zero setting. Choices are:

**Disabled** [default], Enabled

**Power Up**

A Power Up setting of Restart enables the terminal to reuse the last tare weight after a power cycle. If Reset is selected, the terminal returns to gross mode upon power up and the last tare weight after the power cycle is cleared. Selections are:

**Restart** [default], Reset

### 3.5.4.7. Units

This setup screen enables the selection of a second and a third unit and determines which unit is used at power up. If printing of two units is required, establish Third Units. Both Primary and Third units can be printed simultaneously in an output template.

#### 3.5.4.7.1. Second Unit

Use the Second Unit selection box to select a second weighing unit. Only one custom unit is possible.

Available weighing units include:

**None** [default], Custom, pennyweight (dwt), grams (g), kilograms (kg), pounds (lb), pounds-ounces (lb-oz), ounces (oz), troy ounces (ozt), tonnes (t), tons (ton)

#### 3.5.4.7.2. Third Unit

Use the Third Unit selection box to select a third weighing unit. Possible weighing units are:

**None** [default], Custom, pennyweight (dwt), grams (g), kilograms (kg), pounds (lb), pounds-ounces (lb-oz), ounces (oz), troy ounces (ozt), tonnes (t), tons (ton)

#### 3.5.4.7.3. Power Up

Power up units defines the units the terminal defaults to after power up.

**Primary Units**      The terminal restarts in primary units

**Restart** [default]      The terminal restarts with whichever units were last displayed before the power cycle

#### 3.5.4.7.4. Custom Factor

This parameter is shown only if a Custom unit is selected. Enter a multiplication factor for the custom unit in this field, such as 0.592 or 1.019. The primary unit is multiplied by the custom factor to obtain the custom value.

#### 3.5.4.7.5. Custom Name

This parameter is shown only if a Custom unit is selected. Use the alpha keys to enter the name for the custom unit. Up to 12 characters may be entered. The terminal displays the first three letters of the custom name in the units area of the display when custom units are in use.

#### 3.5.4.7.6. Custom Increment

This parameter is shown only if a Custom unit is selected. Enter a custom increment in this field, such as 0.1 or 0.5. This step controls both the decimal position and the increment size of the custom unit value.

### 3.5.4.8. Rate

A Rate, expressed as change in primary or secondary weight units per time unit, may be programmed for display on the IND570 and/or used in controlling discrete outputs – for example as the source for a Comparator (refer to section 3.6.2.2.1, and the **Comparators: Configuration and Operation** section of Chapter 4, **Applications**, for more details).

- The Rate display is selectable for display in the auxiliary display area below the weight display. Refer to section 3.7.2.4, **Terminal I Display I Auxiliary Display**, for more information on using the auxiliary display.

If the weight information in the terminal becomes invalid, the Rate display will show 0.000. The following Rate parameters can be configured:

3.5.4.8.1.

Weight Units

Weight Units define which weight unit will be used for the rate calculation.

<b>None</b> [default]	Rate function is disabled
Primary	Primary weight units are used
Secondary	Secondary weight units are used. A secondary unit must be enabled for this choice to be shown.

3.5.4.8.2.

Time Units

Time Units determine what time reference will be used for the rate value. Choices include:

**Seconds** [default], Minutes, Hours

3.5.4.8.3.

Measurement Period

The Measurement Period value sets the frequency of weight measurements. Choices are:

0.5 seconds, **1 second** [default], 5 seconds

3.5.4.8.4.

Output Average

Output from the rate function is set by a computed rolling average of measurements. This possible range of values is 1 to 99 seconds, with a default value of **5**. The Output Average value should be sufficiently larger than the Measurement Period to allow the terminal to take multiple measurements for each average.

**3.5.4.9.**

**Filter**

The ND570 terminal has a low-pass, multi-pole vibration filter that can be set for several conditions. The heavier the filtering, the slower the display settling time will be. This screen is not accessible when Remote is selected as the scale type.

3.5.4.9.1.

Low Pass Frequency

Low pass frequency is the frequency above which all disturbances are filtered out. The lower the frequency, the better the disturbance rejection, but the longer the settling time required for the scale. Values from 0.2 to 9.9 are possible but values below 1.0 should not be used due to the extremely long settling time. The default value is **2.0** Hz.

3.5.4.9.2.

Low Pass # of Poles

The number of poles determines the slope of the filtering cutoff. For most applications, a slope value of 8 is acceptable; however, decreasing this number will improve settling time slightly. Choices are:

2, 4, 6, **8** [default]



#### 3.5.4.9.3. Notch Filter Frequency

The notch filter allows selection of one specific frequency above the low pass filter value that can also be filtered out. This enables setting the low pass filter lower to filter out all but one frequency (that the notch filter will handle) and obtain a faster settling time. Values from 0 (Disabled) to 99 are possible with a default value of **30** Hz.

#### 3.5.4.9.4. Stability Filter

The stability filter works in conjunction with the standard low pass filter to provide a more stable final weight reading. The setup choices include

**Disabled** [default], Enabled

- The stability filter should only be used in transaction weighing applications, since the nonlinear action of the filter switching may cause inaccurate cutoffs in batching or filling applications.

### 3.5.4.10. Stability

The IND570 terminal includes a stability detector (weight in motion). The Stability setup screen enables setting a motion range, no-motion interval and timeout period.

#### 3.5.4.10.1. Motion Range

Sets the motion range (in divisions) that the weight is permitted to fluctuate and still have a no-motion condition. Values from 0.1 to 99.9 are possible with the default value being **1.0** d.

#### 3.5.4.10.2. No-motion Interval

The no motion interval defines the amount of time (seconds) that the scale weight must be within the motion range setting to have a no-motion condition. Values from 0.0 (motion detection disabled) to 2.0 are possible, the default value being **0.3** seconds. A shorter interval means that a no-motion condition is more likely, but may make weight measurement less precise.

#### 3.5.4.10.3. Timeout

Defines the period (in seconds) after which the terminal stops attempting to perform a function that requires a no-motion condition (such as a zero, tare or print command) and aborts the function. This timeout is used regardless of the source of the command such as the keypad, discrete input, PLC or SICS. Values from 0 to 99 are possible with the default value being **3** seconds. A smaller value means that less time will be used to check for no-motion before aborting a command. When a value of 0 is entered, there must be no-motion when a command is given or it will fail immediately. A value of 99 is a special condition which permits the terminal to wait indefinitely for a no-motion condition - a command would never be aborted.

### 3.5.4.11. Log or Print

The Log or Print setup branch is where the thresholds to control how and when a demand data output is triggered. Normal demand mode printing occurs whenever a print request is made, providing there is no motion on the scale and the weight is above gross zero (a negative gross weight will not be printed).

The weight values entered are the gross weight values in primary units. Gross weight in primary units is used regardless of whether the IND570 is in Gross or Net mode and regardless of the units that are displayed.

## 3.5.4.11.1. Minimum Weight

The minimum weight setting is the threshold below which log or print functions will not initiate. Primary units are displayed for this field.

## 3.5.4.11.2. Interlock

Interlock prevents repeat logging and printing. When enabled, this interlock requires that the live weight reading be reset according to the **Reset On** parameter setting (see below). The live weight must then settle to a weight greater than the Minimum Weight value (see above) before responding to the next log or print request. Choices are:

**Disabled** [default], Enabled

## 3.5.4.11.3. Automatic

This parameter triggers an automatic log and print request every time the weight on the scale settles to a positive value that is larger than the entered Threshold Weight value (see below). After the initial log or print, the automatic trigger must reset per the Reset On parameter setting (see below) before the next automatic log and print can occur. The possible selections for this parameter are:

**Disabled** [default], Enabled

If Automatic is set to Disabled, the Threshold Weight field does not appear.

## 3.5.4.11.4. Reset On

The reset of Interlock and Automatic printing or logging can be based on weight threshold or weight deviation values. Select the desired operating mode and enter the weight value in the "Reset On" field. The choices include:

Deviation	The weight must change more than this absolute value for the Interlock and Automatic print to reset
-----------	---

<b>Return</b> [default]	The weight must return to below this value for the Interlock and Automatic print to reset
-------------------------	---

If both Interlock and Automatic settings are disabled, the Reset On field does not display.

If Reset On is set to Deviation, The Threshold Weight and Motion Check fields do not display.

## 3.5.4.11.5. Threshold Weight

The Threshold Weight is the value above which an Automatic logging or printing of data can/will be triggered. Threshold Weight does not appear if Automatic is set to Disabled or if Reset On is set to Deviation.

## 3.5.4.11.6. Motion Check

Enable the motion check setting to prevent interlock and automatic log and print functions from resetting when the scale is in motion below the "Reset On" return point. Motion Check does not appear if Reset ON is set to Deviation. Choices are:

**Disabled** [default], Enabled

### 3.5.4.12. MinWeigh

If the current net weight is greater than or equal to the MinWeigh value, all terminal functions behave normally. If the absolute value of the net weight is less than MinWeigh, the weight display includes a flashing MinWeigh symbol  to the left of the weight. If the user attempts to record the weight while in this condition, the printout will include an asterisk (\*).

#### 3.5.4.12.1. MinWeigh

This selects the operating mode of the MinWeigh feature. Choices include:

<b>Disabled</b> [default]	The MinWeigh feature will not operate.
Calculated	The MinWeigh feature will operate and the MinWeigh value will be calculated based on measurement values entered.
Direct Entry	The MinWeigh feature will operate and the MinWeigh value will be directly entered by hand.

#### 3.5.4.12.2. Calculated Mode

When **Calculated** is selected, the user is prompted to enter the uncertainty  $U_0$ , c factor, tolerance percent, and safety factor in data entry boxes. The new MinWeigh value is then computed using these values. The MinWeigh value can be viewed but not directly edited in this mode. Where:

Uncertainty $U_0$	Uncertainty in measurement as the applied load approaches 0. $U_0$ is computed differently in each country and is entered in Primary units of measure.
Uncertainty c	Uncertainty factor related to the portion of uncertainty in measurement that is proportional to the applied load.
Tolerance	Tolerance in percent, which reflects the tolerances required for the specific process and facility. The range is 0.1%–99.9%.
Safety Factor	To calculate the minimum weight the safety factor is usually $SF = 1$ . However, if the customer would like to recalculate this number for purposes of more closely matching a GWP Recommendation this value will generally be specified by the customer starting at 2. The integer value range is 1–10 and is used to determine the exclusion range.

#### 3.5.4.12.3. Direct Entry Mode

For **Direct Entry** of a MinWeigh value, user enters the desired value for MinWeigh directly in the MinWeigh data entry box. The MinWeigh value is entered in Primary units of measure.

### 3.5.4.13. Reset

Refer to section 3.5.6 on page 3-68.

## 3.5.5. Scale – Remote Display

Many of the setup parameters not used when remote display is selected as the scale type are still shown in the menu tree. Only the parameters that affect remote display functionality are listed here. Parameters not listed have no effect on the remote display operation.

### 3.5.5.1. Type

The Scale Type screen permits a name to be assigned to the remote display and allows the IND570 to be configured as a remote display for another terminal. The EXIT softkey  will return the display to the menu tree.

#### 3.5.5.1.1. Name

The Name field enables entry of the remote display identification. Enter the name (an alpha-numeric string of up to 20 characters) in the Name entry box.

#### 3.5.5.1.2. Scale Type

The Scale Type field indicates which type of scale this terminal supports and allows selection of Remote Display mode. The choice will be either the scale type supported by the PCB present in the terminal or Remote Display. For example:

Analog, IDNet, SICSprou, POWERCELL, Remote

Refer to Chapter 4, **Applications**, for specific instructions on configuring the terminal for use as a remote display.

### 3.5.5.2. Capacity & Increment

When Remote is selected as the scale type, the capacity and increment size are available. These parameters are used to determine the size of the digits used in the weight display and should be entered based on the values from the master terminal.

#### 3.5.5.2.1. Primary Units

Set the primary units from the selection box choices, which include:

grams (g), **kilograms (kg)** [default], pounds (lb), tonnes (t), tons (ton)

#### 3.5.5.2.2. # Ranges/Intervals

Select the multi-interval or multiple range mode and set the number of ranges or intervals from the selections:

1 [default], 2 intervals, 2 ranges, 3 intervals, 3 ranges

##### >|1|< - Range/Interval 1 Values

Specify the capacity and then the increment size for range or interval 1.

##### >|2|< - Range/Interval 2 Values

When more than one range is selected, these parameters provide entry of the capacity and then the increment size for the second range or interval.

##### >|3|< - Range/Interval 3 Values

When three ranges or intervals are selected, these parameters provide entry of the capacity and then the increment size for the third range or interval.

3.5.5.2.3. Blank Over Capacity  
The Blank Over Capacity parameter is not used when Remote Display is selected as the scale type.

### **3.5.5.3. Calibration**

The Calibration screens are not available when Remote Display is selected as the scale type.

### **3.5.5.4. Zero**

Although the Zero screens are available when Remote Display is selected as the scale type, most parameters are not used.

#### 3.5.5.4.1. AZM & Display

None of the AZM & Display screens are functional when Remote Display is selected as the scale type.

#### 3.5.5.4.2. Ranges

Use the settings on the Ranges screen to enable or disable Pushbutton Zero from the remote display.

#### 3.5.5.4.3. Power Up Zero

The Power Up Zero parameter is not used when Remote Display is selected as the scale type.

#### 3.5.5.4.4. Power Up Zero Range

The Power Up Zero Range parameter is not used when Remote Display is selected as the scale type.

#### 3.5.5.4.5. Pushbutton Zero

If Pushbutton Zero is enabled, the keypad ZERO pushbutton will operate to capture new zero reference points. The choices for pushbutton zero are:

Disabled, **Enabled** [default]

If Pushbutton Zero is Disabled, execution of a remote zero is still possible via SICS, CPTZ, SMA commands from a PC, a discrete input or from PLC commands.

#### 3.5.5.4.6. Pushbutton Zero Range

The Pushbutton Zero Range parameter is not used when Remote Display is selected as the scale type.

### **3.5.5.5. Tare**

Tare is used to subtract the weight of an empty container from the gross weight on the scale to determine the net weight of the contents. Tare is inhibited if the scale is in motion. This branch provides access to program the tare types, auto tare and auto clear tare parameters.

#### 3.5.5.5.1. Tare Types

Use the Tare Types setup screen to enable or disable pushbutton tare, keyboard tare and net sign correction. (solo en celdas de carga IDNet).

**Pushbutton Tare**

When pushbutton tare is enabled, the front panel tare key  can be pressed to send a tare command to the master terminal. The master terminal will then determine if the tare can be applied or not. The selections include:

Disabled, **Enabled** [default]

If Pushbutton Tare is Disabled, execution of a remote Tare is still possible via SICS, CPTZ, and SMA commands from a PC, a discrete input, or using PLC commands.

**Keyboard Tare**

When keyboard tare is enabled, the known value for the empty weight of a container (tare) can be entered manually (preset tare) and sent to the master terminal. The master terminal will then determine if the preset tare can be applied or not. Choices are:

Disabled, **Enabled** [default]

**Net Sign Correction**

Net sign correction enables the Remote Display to be used for both shipping (inbound empty) and receiving (inbound loaded) operations. If net sign correction is enabled, the remote display will switch the gross and tare weight fields on the printed ticket, if necessary, so that the larger weight is the gross weight, the smaller weight is the tare weight, and the difference is always a positive net weight. Net sign correction affects the printed data output, the recalled weight display and the displayed weight. Continuous data output will continue to show a negative net weight value. The choices for Net Sign Correction are:

**Disabled** [default], Enabled

Net sign correction will operate with pushbutton tare, preset tare, or tare records stored in the Tare Table of the master terminal. An example of weight values with and without net sign correction is shown in Table 3-6. In this example, the tare register value is 53 kg and the live weight on the scale is 16 kg.

**Table 3-6: Weight Values With and Without Net Sign Correction**

Printed and Displayed	Net Sign Correction	
	Disabled	Enabled
Gross	16 kg	53 kg
Tare	53 kg	16 kg
Net	- 37 kg	37 kg

- When net sign correction is enabled, the tare weight field in the recall display will be labeled with the letter "M" to indicate "Memory" instead of "T" or "PT".

3.5.5.5.2. Auto Tare

When the scale type is set to Remote Display, all auto tare screens are disabled.

3.5.5.5.3.

Auto Clear Tare

None of the Auto Clear Tare screens are functional when Remote Display is selected as the scale type.

**3.5.5.6.**

**Units**

None of the Units screens are functional when Remote Display is selected as the scale type.

**3.5.5.7.**

**Rate**

A Rate, expressed as change in primary or secondary weight units per time unit, may be programmed for display on the IND570 and/or used in controlling discrete outputs – for example as the source for a Comparator (refer to section 3.6.2.2.1, and the **Comparators: Configuration and Operation** section of Chapter 4, **Applications**, for more details).

- The Rate display is selectable for display in the auxiliary display area below the weight display. Refer to section 3.7.2.4, **Terminal I Display I Auxiliary Display**, for more information on using the auxiliary display.

If the weight information in the terminal becomes invalid, the Rate display will show 0.000. The following Rate parameters can be configured:

3.5.5.7.1.

Weight Units

Weight Units define which weight unit will be used for the rate calculation.

<b>None</b> [default]	Rate function is disabled
Primary	Primary weight units are used
Secondary	Secondary weight units are used. A secondary unit must be enabled for this choice to be shown.

3.5.5.7.2.

Time Units

Time Units determine what time reference will be used for the rate value. Choices include:

**Seconds** [default], Minutes, Hours

3.5.5.7.3.

Measurement Period

The Measurement Period value sets the frequency of weight measurements. Choices are:

0.5 seconds, **1 second** [default], 5 seconds

3.5.5.7.4.

Output Average

Output from the rate function is set by a computed rolling average of measurements. This possible range of values is 1 to 99 seconds, with a default value of 5. The Output Average value should be sufficiently larger than the Measurement Period to allow the terminal to take multiple measurements for each average.

**3.5.5.8.**

**Filter**

None of the Filter screens are functional when Remote Display is selected as the scale type.

**3.5.5.9. Stability**

None of the Stability screens are functional when Remote Display is selected as the scale type.

**3.5.5.10. Log or Print**

The Log or Print setup branch is where the thresholds to control how and when a demand data output is triggered. A print request at the remote display causes the "P" command to be sent to the master terminal. The master terminal may then print (if it has a local print connection) and the master terminal will also set the print bit in the continuous output to the remote display to indicate to the remote display that it should print if it has a demand connection. Normal demand mode printing occurs whenever a print request is made, providing there is no motion on the scale and the weight is above gross zero (a negative gross weight will not be printed).

The weight values entered are the gross weight values in primary units. Gross weight in primary units is used regardless of whether the IND570 is in Gross or Net mode and regardless of the units that are displayed.

**3.5.5.10.1. Minimum Weight**

The minimum weight setting is the threshold below which log or print functions will not initiate. Primary units are displayed for this field. If the weight is below this value, a print request will not be sent to the master terminal.

**3.5.5.10.2. Interlock**

Interlock prevents repeat logging and printing. When enabled, this interlock requires that the live weight reading be reset according to the **Reset On** parameter setting (see below). The live weight must then settle to a weight greater than the Minimum Weight value (see above) before responding to the next log or print request. Choices are:

**Disabled** [default], Enabled

**3.5.5.10.3. Automatic**

This parameter triggers an automatic log and print request every time the weight on the scale settles to a positive value that is larger than the entered Threshold Weight value (see below). After the initial log or print, the automatic trigger must reset per the Reset On parameter setting (see below) before the next automatic log and print can occur. The possible selections for this parameter are:

**Disabled** [default], Enabled

If Automatic is set to Disabled, the Threshold Weight field does not appear.

**3.5.5.10.4. Reset On**

The reset of Interlock and Automatic printing or logging can be based on weight threshold or weight deviation values. Select the desired operating mode and enter the weight value in the "Reset On" field. The choices include:

**Deviation**            The weight must change more than this absolute value for the Interlock and Automatic print to reset

**Return** [default]    The weight must return to below this value for the Interlock and Automatic print to reset



If both Interlock and Automatic settings are disabled, the Reset On field does not display.

If Reset On is set to Deviation, The Threshold Weight and Motion Check fields do not display.

3.5.5.10.5. Threshold Weight

The Threshold Weight is the value above which an Automatic logging or printing of data can/will be triggered. Threshold Weight does not appear if Automatic is set to Disabled or if Reset On is set to Deviation.

3.5.5.10.6. Motion Check

Enable the motion check setting to prevent interlock and automatic log and print functions from resetting when the scale is in motion below the "Reset On" return point. Motion Check does not appear if Reset ON is set to Deviation. Choices are:

**Disabled** [default], Enabled

**3.5.5.11. MinWeigh**

If the current net weight is greater than or equal to the MinWeigh value, all remote display functions behave normally. If the absolute value of the net weight is less than MinWeigh, the weight display includes a flashing MinWeigh symbol  to the left of the weight. If the user attempts to record the weight while in this condition, the printout will include an asterisk (\*).

3.5.5.11.1. MinWeigh

This selects the operating mode of the MinWeigh feature. Choices include:

- Disabled** [default] The MinWeigh feature will not operate.
- Calculated The MinWeigh feature will operate and the MinWeigh value will be calculated based on measurement values entered.
- Direct Entry The MinWeigh feature will operate and the MinWeigh value will be directly entered by hand.

3.5.5.11.2. Calculated Mode

When **Calculated** is selected, the user is prompted to enter the uncertainty  $U_0$ , c factor, tolerance percent, and safety factor in data entry boxes. The new MinWeigh value is then computed using these values. The MinWeigh value can be viewed but not directly edited in this mode. Where:

- Uncertainty  $U_0$  Uncertainty in measurement as the applied load approaches 0.  $U_0$  is computed differently in each country and is entered in Primary units of measure.
- Uncertainty c Uncertainty factor related to the portion of uncertainty in measurement that is proportional to the applied load.
- Tolerance Tolerance in percent, which reflects the tolerances required for the specific process and facility. The range is 0.1%–99.9%.
- Safety Factor To calculate the minimum weight the safety factor is usually  $SF = 1$ . However, if the customer would like to recalculate this number for purposes of more closely matching a GWP Recommendation this value will generally be specified by the customer starting at 2. The integer value range is 1–10 and is used to determine the exclusion range.

3.5.5.11.3. Direct Entry Mode

For **Direct Entry** of a MinWeigh value, user enters the desired value for MinWeigh directly in the MinWeigh data entry box. The MinWeigh value is entered in Primary units of measure.

**3.5.5.12. Reset**

Refer to section 3.5.6, below.

**3.5.6. Reset**

The Reset screen enables Scale branch setup values to be reset to factory default settings.

To initiate a reset, press the OK softkey . If the reset was successful, a verification message that reads "Reset Successful" displays. If the reset was not successful, an error message that reads "Reset Failure" displays. If the reset fails, try to initiate the reset again. If the reset continues to fail, contact a local METTLER TOLEDO representative for assistance.

Press the ESCAPE softkey  to exit without resetting.

- Scale Reset does NOT include the reset of metrologically significant parameters – scale type, approval, weight units, capacity, increment, or calibration data. This data is reset only by performing a Master Reset with switch 2-1 in its ON position, or a Reset function in the IDNet or SICSprou load cell.

## 3.6. Application

Use application setup screens to configure the setup parameters shown below:

**3.6.1. Memory**

The memory branch of setup provides access to parameters for Alibi memory, the Tare and Target tables and the Message table.

**3.6.1.1. Alibi**

The Alibi memory table stores basic transaction information that is not user-definable. Alibi memory is configured as a "ring" buffer that overwrites the oldest record when it reaches its memory limit. Alibi memory can hold approximately 100,000 transactions before it reaches its limit and begins overwriting old transactions. The selections are:

**Disabled** [default], Alibi Memory, Action Log (only when Fill-570 is installed)

More detailed information about Alibi memory can be found in Chapter 2, **Operation**, and in Appendix B, **Table and Log File Structure**.

- If the IND570 terminal has been programmed as "approved", Alibi memory enabling or disabling is only accessible if the security switch (SW1-1) is in the OFF position.

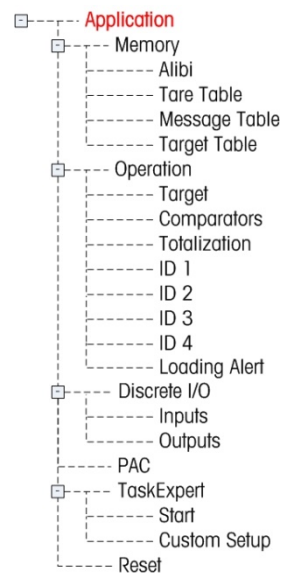



- To clear the Alibi memory table, disable the Alibi memory, exit  the Alibi setup screen, and then enable Alibi again.

#### 3.6.1.1.1. To View Alibi Memory Records

Press the VIEW TABLE softkey . The Alibi Search screen displays.

1. Use the selection boxes and associated fields to enter specific search information to limit the search, or enter \* (the “find all” character) to view all information. A maximum of two search fields are provided.
2. Press the START SEARCH softkey . The Alibi Search View screen displays with the search results. Records are ordered by time, with the oldest shown first.
3. Press the UP, DOWN, LEFT, and RIGHT navigation keys to scroll up and down and across the screen in order to view all data and all records listed.

#### 3.6.1.1.2. To Print Alibi Memory Records

1. Press the PRINT softkey  to print the list.
2. Press the EXIT softkey  to return to the Alibi Search Screen.

### 3.6.1.2. Tare Table

The Tare Table displays stored tare records, including an ID, description, tare weight value and unit, the number of transactions in which the tare was used and the accumulated weight of all transactions using the tare ID.

More detailed information about the tare table memory can be found in Chapter 2, **Operation**, and in Appendix B, **Table and Log File Structure**.

Use the Tare Table setup screen to enable or disable description and to configure totalization. Press the CLEAR softkey  to reset the table.

#### 3.6.1.2.1. Description

Description is an alphanumeric string that describes the Tare Table entry. Use the Description selection box to enable or disable Description in the Tare Table structure. Choices are:

**Disabled** [default], Enabled

#### 3.6.1.2.2. Totalization

Totalization is a field that tracks the total weight for all transactions involving each tare in the table. The possible selections are:

**None** [default], Displayed Weight, Gross Weight

#### 3.6.1.2.3. Tare Table Records

Depending on the selections made in setup, Tare Table records can include the following fields:

<b>ID</b>	Identification number for the active record
<b>Description</b>	Descriptive identification for the active record
<b>Tare Weight</b>	Desired preset tare value









<b>Tare Units</b>	Units of measure for the tare (tare record units can be any available primary unit)
<b>n</b>	Number of transactions in which the tare record has been used.
<b>Total</b>	Accumulated weight of all transactions using the tare ID

#### To View Tare Table Records

Press the VIEW TABLE softkey . The Tare Search screen displays.

1. Use the selection boxes and associated fields to enter specific search information to limit the search, or enter \* (the "find all" character) to view all Tare Table information.
2. Press the START SEARCH softkey . The Tare Search View screen displays with the search results. Only records with non-null tare values display. Records are ordered by ID, with the lowest ID number shown first.
3. Press the UP, DOWN, LEFT, and RIGHT navigation keys to scroll up and down and across the screen in order to view all data and all records listed.

#### To Modify or Add Tare Table Records

1. Press the UP and DOWN navigation keys to select (highlight) a record in the table.
2. Press the EDIT softkey  to open the setup screen for editing a record or press the NEW softkey  to open the setup screen to create a new table record.
3. Press the UP and DOWN navigation keys to move the focus to the field name to be edited or inserted.
4. Press the ENTER key to select a field value to edit or insert. The alpha keys display.
5. Use the alpha keys and the numeric keypad to edit or enter the desired value.
6. When the tare entry field is highlighted, press the TARE softkey  to capture the current live scale weight and unit.
7. Press the OK softkey  to accept the modifications or additions to the Tare Table.
8. Press the ESCAPE softkey  to return to the Tare Search View screen without saving modifications or additions.
9. Press the DELETE softkey  to delete a tare record in the list.
10. Press the PRINT softkey  to print the list. Login must be at supervisor level or above to print the table.
11. Press the EXIT softkey  to return to the Tare Search Screen.



#### 3.6.1.3.

#### Message Table

The Message Table displays stored text messages and corresponding ID numbers that can be used in print templates. Only message records with non-null values display.

Press the CLEAR softkey  to clear the entire table.

### To View, Edit, Delete or Print Message Table Records

1. Use the selection boxes and associated fields to enter specific search information to limit the search, or do not enter any search limits to view all Message Table information.
2. Press the START SEARCH softkey . The Message Search View screen displays with the search results. Records are ordered by ID, with the lowest ID number shown first.
3. Press the UP and DOWN navigation keys to scroll up and down the screen in order to view all data and all records listed.
4. Modify or add Message Table information by editing, inserting, or deleting information as described previously under Tare Table.
5. Press the PRINT softkey  to print the list.
6. Press the EXIT softkey  to return to the Search Screen.

#### 3.6.1.4. Target Table

Target comparison can be used in two types of applications: material transfer and over/under. Material Transfer mode is used in filling and dosing applications. Over/Under mode is used in checkweighing applications to quickly classify a load placed on the scale platform as OK or above or below a target value. Target comparison is disabled in the terminal until a target table Mode is selected.

Use the Target Table setup screen to select the mode, tolerance type, and output type for use in target comparison.

Press the CLEAR softkey **C** to reset the entire target table. Log-in must be at supervisor level or Oabove to clear the table.

Additional information about the target table can be found in Chapter 2, **Operation**, and in Appendix B, **Table and Log File Structure**.

##### 3.6.1.4.1. Mode

Use the Mode selection box to select the type of application for target comparison. Selections include:

**None** [default], Material Transfer, Over/Under

##### 3.6.1.4.2. Tolerance Type

Use the Tolerance Type selection box to select the type of tolerance to be used for target comparison. The choices are:

<b>Target Deviation</b> [default]	Positive tolerance and negative tolerance values can be entered as a deviation weight value in the same units as the target
% of Target	Positive tolerance and negative tolerance values can be entered as a percent of the target value
Weight Value (Over/Under only)	No absolute target value is defined; the under limit and over limit values are used as zone edges for OK to define the acceptable range

3.6.1.4.3. Output Type

The Output Type field is available only when the Material Transfer mode is selected. Use the Output Type selection box to select the type of two-speed output to be used in the target application. Selections include:

<b>Concurrent</b> [default]	Both Feed and Fast Feed outputs operate at the same time
<b>Independent</b>	One output operates at a time (Fast Feed then Feed)

3.6.1.4.4. Totalization

Totalization is a field that tracks the total weight for all transactions involving each target in the table. The possible selections are:



**None** [default], Displayed Weight



3.6.1.4.5. Target Table Records

Depending on the selected Mode, Target Table records can include the following fields:

<b>ID</b>	Identification number for the active record
<b>Description</b>	Descriptive identification for the active record
<b>Target Weight</b>	Desired measured value for a weighment
<b>Target Units</b>	Units of measure for the target weight (the target record units and the comparison units can be a combination of primary, second or third units)
<b>Spill</b>	Amount of material delivered after the control device is signaled to stop (material transfer mode only)
<b>Positive Tolerance</b>	Highest acceptable tolerance above a target value
<b>Negative Tolerance</b>	Lowest acceptable tolerance below a target value
<b>Fine Feed</b>	For two-speed applications, the fine feed value is the amount of material delivered at the slower speed (material transfer mode only)
<b>n</b>	Number of transactions in which the target record was used
<b>Total</b>	Accumulated weight of all transactions using the target ID

**To View, Edit, Delete or Print Target Table Records**

1. Press the VIEW TABLE softkey . The Target Search screen displays.
2. Use the selection boxes and associated fields to enter specific search information to limit the search, or do not enter any search limits to view all Target Table records.
  - Search fields that display in the Search Field selection box vary depending on the selections made on the Target Table setup screen.
3. Press the START SEARCH softkey . The Target Search View screen displays with the search results. Only records with non-null values display. Records are ordered by ID, with the lowest ID number shown first.
4. Press the UP, DOWN, LEFT, and RIGHT navigation keys to scroll up and down and across the screen in order to view all data and all records listed.

5. Target Table records include different information, depending on the selections made on the Target Table setup screen. For example, Over Limit and Under Limit data displays only when the Over/Under mode is selected with Weight Value tolerance type.
6. Modify or add Target Table information by editing, inserting, or deleting information as described previously under Tare Table.
7. Press the PRINT softkey  to print the list.
8. Press the EXIT softkey  to return to the Search Screen.

### 3.6.2. Operation

Operation setup screens include Target, Comparators, Totalization and ID1 through ID4.

#### 3.6.2.1. Target

Use this setup screen to select which live measurement data (source) to use as the weight input for target comparison and to determine the discrete output operation in Over/Under mode and Material Transfer mode.

##### 3.6.2.1.1. Source

Select which source to use as input for target comparison. Choices include:

**Displayed Weight** [default], Gross Weight.

##### 3.6.2.1.2. Motion Check

This parameter is shown only if target mode is set to Over/Under (refer to section 3.6.1.4.1, **Application | Memory | Target Table | Mode**). If Motion Check is enabled, the discrete outputs for Over, Under and OK are only activated when a no-motion condition is detected. Selections for this parameter include:

**Disabled** [default], Enabled

##### 3.6.2.1.3. Latching



This parameter is shown only if target mode is set to Material Transfer (refer to section 3.6.1.4.1, **Application | Memory | Target Table | Mode**). When output latching is enabled, the target comparison outputs (for example, the Feed output) remain latched (OFF) after the output switching threshold is exceeded until the latch is reset by the next start input (softkey or discrete input). Setup choices are:



Disabled, **Enabled** [default]

- If latching is disabled, the outputs will operate as coincidence-type outputs: the target comparison outputs will be ON until the live weight passes the output switching threshold. The output will then turn OFF. The output will turn ON again immediately when the live weight drops below the output switching threshold. Unlatched outputs are acceptable for applications such as tank level measurement, but **potentially dangerous for filling applications**. Refer to Chapter 4, **Applications**, for more information on using coincidence-type and latched outputs.

### 3.6.2.2. Comparators

The Comparators screen permits the configuration of simple comparators controlled either by comparison to a limit value or by comparison with a range, and used as an assignment for discrete outputs. The source for comparison can be the Gross Weight, Displayed Weight, Rate or assigned by a custom TaskExpert application.

This screen displays all five Comparators, and contains columns for ID, Description, Source, Limit, Unit, High Limit, and Active condition. From here, it is possible to EDIT  a Comparator, DELETE one , or CLEAR  all Comparators.

Once parameters have been set in the Comparator Edit screen, they can be saved by pressing OK , or discarded by pressing ESCAPE . In either case, the view returns to the Comparators screen.

#### 3.6.2.2.1. Source

If None or Application is selected as the source, no other parameter fields are displayed. If a weight field is selected as the Source, the weight unit will be primary units. If Rate is selected as the Source, then the unit will be the same as selected for Rate in the **Scale > Rate** branch. The choices for Source include:

None [default]	Comparator disabled
Application	Comparator controlled by a TaskExpert program
ABS – Displayed Weight	Comparator triggered on the absolute value of the displayed weight (no consideration for whether the value is positive or negative)
ABS – Rate	Comparator triggered on the absolute value of the rate (no consideration for whether the value is positive or negative)
Displayed Weight	Comparator triggered on the displayed weight
Gross Weight	Comparator triggered on the gross weight
Rate	Comparator triggered on the rate

#### 3.6.2.2.2. Active

The Active setting determines how the source field will be compared to the limit value or the range between the limit and high limit values.

< [default]	Comparator will be "ON" when the source value is <b>less than</b> the limit
<=	Comparator will be "ON" when the source value is <b>less than or equal to</b> the limit
=	Comparator will be "ON" when the source value is <b>equal to</b> the limit
>=	Comparator will be "ON" when the source value is <b>greater than or equal to</b> the limit
>	Comparator will be "ON" when the source value is <b>greater than</b> the limit
< >	Comparator will be "ON" when the source value is <b>not equal to</b> the limit
_< >_	Comparator will be "ON" when the source value is <b>outside the range</b> of the limit and the high limit
>_ <_	Comparator will be "ON" when the source value is <b>within the range</b> of the limit and the high limit



- 3.6.2.2.3. Description  
The description is an alphanumeric string that is used to identify the type and purpose of the comparator. This string appears, together with the automatically assigned ID number (1-5), in the list that displays when the Comparator softkey is pressed. The maximum length is 20 characters.
- 3.6.2.2.4. Limit  
The Limit either sets the comparison value to which the actual source value is compared, or the lower comparison value for the range to which the currently measured source value is compared.
- 3.6.2.2.5. High Limit  
The High Limit is available only for Range mode, and sets the upper comparison value for the range to which the currently measured source value is compared. Its value must be higher than the Limit. If a lower value is entered, the terminal will show an Invalid Value message when the OK softkey  is pressed.

### 3.6.2.3. Totalization

The IND570 terminal provides totalization in both grand total (GT) and subtotal (ST) registers and counters. The counters record the number of transactions for which a totalization was done and the registers track the totalization of weight each time a PRINT is triggered.

Counters have a limit of 1,500,000 and registers will accumulate up to 11 digits of weight including any decimal places to the right of the decimal point. For example, a scale programmed for 500 x 0.1 kg will accumulate weight values up to 9999999999.9 (11 total digits). If either of these limits is exceeded, an error message will display and the totals must be reset before additional weights or counts will be added.

Use the Totalization setup screen to select parameters for totalization operations, including which source to use as input for totalization, settings for grand totals and subtotals, and to enable or disable the conversion of second or third unit weights for totalization.

- 3.6.2.3.1. Mode  
Select which source to use as input for totalization comparison. A selection of None disables totalization. Possible selections are:

**None** [default], Displayed Weight, Gross Weight

- 3.6.2.3.2. Clear GT on Print  
The Grand Total (GT) can be configured to clear automatically after printing the Totals report. If Clear GT on Print is enabled, the subtotal also clears automatically after printing the Totals report. The choices for this parameter are:

**Disabled** [default], Enabled

- 3.6.2.3.3. Subtotal  
The Subtotal (ST) register can be separately disabled while the Grand Total register continues to accumulate weights. Choices are:

**Disabled** [default], Enabled

- 3.6.2.3.4. Clear ST on Print
- Clearing the subtotal on print and not clearing the grand total on print allows the subtotal register to totalize sub-sets of weighments and to be reset while the grand total continues to track the grand total of weight. Selections for this are:

**Disabled** [default], Enabled

- 3.6.2.3.5. Convert Weight
- The total registers always store weights in primary units. If Convert Weight is disabled, scale weights other than primary units are not accumulated. If Convert Weight is enabled, then the weight is converted to primary units, and then accumulated. The selections are:

Disabled, **Enabled** [default]

### 3.6.2.4. **ID1, ID2, ID3 and ID4**

ID prompting allows the terminal to be configured so that it leads an operator through a specific series of actions, such as entering data, setting a tare value, or sending a print output. This is useful for tasks that must be repeated in precise sequence, and in which specific kinds of input are needed at various steps in the process. Each sequence can consist of up to 30 steps. All IDs can be started manually, by pressing a softkey, or (in the case of ID1 only) automatically, when the weight on the scale passes a programmed threshold. IDs can be programmed to run through the sequence one time or to loop continuously.

- 3.6.2.4.1. ID Mode
- This step determines what will trigger the start of the specific ID sequence. ID1 has an extra choice of Automatic to trigger automatically when the weight on the scale exceeds a programmable threshold value. ID2, ID3 and ID4 can only be triggered by softkey. Selections are:

**None** [default], Automatic (ID1 only), Softkey

- 3.6.2.4.2. Looping
- This step is available when the ID Mode is selected as Softkey. If enabled, the ID sequence will continuously cycle until the EXIT softkey  is pressed. The selections for Looping are:







**Disabled** [default], Enabled

- 3.6.2.4.3. Threshold
- This step is available only if Automatic Mode is selected for ID1. The ID1 sequence starts when a weight above the Threshold weight value is placed on the scale. The weight must fall below the programmed reset weight value (refer to the description below) before it will automatically trigger again.

- 3.6.2.4.4. Reset
- This step is available only if Automatic Mode is selected for ID1. The automatic start trigger rearms after the weight falls below the Reset weight value.

### 3.6.2.4.5. Configuring ID Sequence Steps

Once the Mode Parameters have been set, ID1, ID2, ID3 and ID4 sequence steps can be viewed, created, edited or deleted by pressing the VIEW TABLE softkey .

1. The ID Search screen displays, permitting the search results to be filtered by # (step number), Type, Length or Prompt.
2. Either select a field to search and enter a comparative operator (<, <=, =, >=, >, <>) and alphanumeric information in the Data fields; or leave the wildcard asterisk (\*) in the Data field to view all existing steps.
3. Press the START SEARCH softkey  to display the ID View screen. From here, ID steps can be edited , created , erased  and printed .
4. The ID Edit screen is accessed by pressing the NEW softkey  or the EDIT softkey . The parameters that can be set for each step depend on the Type of step selected are shown in Table 3-7.



The # (step number) is automatically assigned. It determines the order in which the steps will execute. Steps may be inserted into an existing sequence by selecting an entry and pressing the NEW softkey  to define a new step. The newly created step will appear in the sequence before the selected entry, and all subsequent # values will increase by one. To move a step in the sequence, it must be deleted and re-entered in the appropriate position.



**Table 3-7: Types of ID Steps**

Type	Parameters	Options
Alphanumeric, Numeric	Prompt	Enter up to 30 characters as the text or prompt for the step to display on-screen during the ID sequence.
	Length	Enter numeric value (0 - 40) to constrain the length of the response input after the prompt. If length of 0 is entered, the prompt is shown without an entry field. The step is then displayed as an instruction in the sequence. In this case, ENTER must be pressed to move to the next step. During entry, once the length value is met, the terminal will not accept further input; incorrect entries can be deleted using the CLEAR key.
	Clear Data	Permits the entered response (e.g., Operator's name) to be retained from one cycle to the next. <b>Disabled</b> - the next time the step displays it contains the data entered during the previous cycle. Pressing ENTER accepts the value and moves to the next step or any entry will overwrite the previous data. <b>Enabled</b> - the entry field will be blank when viewed the next time.
Clear Tare Print Tare – Auto	None	The selected function will be executed automatically
Selection List	Prompt	Refer to <b>Prompt</b> , above
	# of Selections	The number of choices in the selection box can be set from 2 to 6.
	Clear Data	<b>Disabled</b> - retains the previous selection as the beginning point for the next cycle. <b>Enabled</b> – the selection list will restart at the first selection on the next cycle

Type	Parameters	Options
Tare – Preset	Prompt	Refer to <b>Prompt</b> , above
	Length	Refer to <b>Length</b> , above
	Clear Data	Refer to <b>Clear Data</b> in <b>Alphanumeric and Numeric</b> , above

- As many as 30 steps can be created for each ID. However, each ID sequence can have only one Selection list step.

Once parameters have been set in the ID Edit screen, they can be saved by pressing OK , or discarded by pressing ESCAPE . In either case, the view returns to the ID View screen.

- The ID sequence can be printed from the ID View screen using the PRINT softkey . A Reports connection is required for successful printing (for more details refer to section 3.8.5, **Communication I Connections**, and the **Basic Functionality I Printing I Report Printing** section of Chapter 2, **Operation**, and Appendix C, **Communication I Reports**). Return to the setup menu tree by pressing the EXIT softkey .

### 3.6.2.5. Loading Alert (POWERCELL only)

The IND570 and IND570xx terminals provide visual guidance to assist users in centering the load to be weighed on a PowerDeck platform. Placing the load's center of gravity near the geometric center of the platform's load cell arrangement provides for optimal weighing results. Once enabled, a Loading Alert screen will display any time an off-center load condition is detected.

The Loading Alert displays as a rectangle representing the scale base, with each load cell keyed with a number 1 through 4. A dot appears within the quadrant experiencing the most extreme weight deviation. This is a live screen and the dot will update position as the load is adjusted on the platform. Once triggered, the Loading Alert must be manually acknowledged by the user or the user must adjust the load so that the load's center of gravity is detected within the OK Zone. The Loading Alert will reset when the weight on the platform drops below the configured Threshold Weight value.

No other terminal functions are impacted while the Loading Alert screen is active. All configured communications, discrete inputs and outputs, and terminal functions such as Tare and Print can be executed.

#### 3.6.2.5.1. Loading Alert

When Loading Alert is enabled, the terminal will monitor for the center of gravity of any load that passes the configured Threshold Weight. The choices for this parameter are:

**Disabled [default], Enabled**

If Loading Alert is Disabled, no additional setup selections are provided.

#### 3.6.2.5.2. Threshold Weight

The Threshold Weight is the weight above which the Loading Alert is triggered. When the weight on the platform falls below the Threshold Weight, such as when a load has been removed, the terminal automatically resets the Loading Alert.

**200** is the default value.

### 3.6.2.5.3.

#### OK Zone

The OK Zone defines an area around a platform's geometric center of gravity. When the center of gravity of a load is measured outside the OK Zone, the Loading Alert is triggered.

The OK Zone must be a whole number between 5 and 50. The default value is **30%**.

### 3.6.2.5.4.

#### Platform Size

Input the length and width of the connected PowerDeck platform. These values are used to calculate the geometric center of the platform's load cell arrangement. Selectable units are **mm** [default] and inches.

Press the EXIT softkey  to return to the menu tree.

## 3.6.3.



### Discrete I/O

These screens provide access to the assignments for discrete inputs and discrete outputs.

### 3.6.3.1.



#### Inputs

The Discrete Inputs screen displays discrete input assignments, including the input assignment address, polarity, and function. Only records with non-null values display.

To clear the entire table, press the CLEAR softkey , then press OK  to confirm the action. Press the UP and DOWN navigation keys to scroll up and down the screen in order to view all of the possible discrete input assignments.

### 3.6.3.1.1.

To add or modify discrete inputs

1. Press the UP and DOWN navigation keys to select (highlight) a discrete input.
2. Press the EDIT softkey  to open the setup screen for editing an existing input assignment or press the NEW softkey  to open the setup screen to create a new input assignment.
3. Enter the **Input Assignment** address. The input address is shown as [x.y.z] where x indicates the input location, y indicates the slot address of the I/O option, and z indicates the input position. The input address digits are:
  - Location – The first digit represents whether the I/O is local (0) or remote (1–3).
  - Slot Address – The second digit will always be a 1 for the IND570 internal I/O and a 0 for the remote I/O (ARM 100).
  - Position – The third digit refers to the position (1–5) of the discrete input option (internal or remote) that is being assigned to a function.

Valid address numbers are:

I/O Module	Valid Addresses
Local 2in/5out	0.1.1, 0.1.2
Local 5in/8out	0.1.1, 0.1.2, 0.1.3, 0.1.4, 0.1.5
Remote #1	1.0.1, 1.0.2, 1.0.3, 1.0.4
Remote #2	2.0.1, 2.0.2, 2.0.3, 2.0.4

Remote #3                      3.0.1, 3.0.2, 3.0.3, 3.0.4

**Examples:**

Address 0.1.1 = Local discrete board, position 1.



Address 1.0.3 = Remote address #1, position 3.

1. The inputs can be programmed to accept either a + True or –True polarity level as “ON”. When input polarity is + True, the input will be “ON” when there is voltage detected. When input polarity is - True, the input will be “ON” when there is no voltage detected. Use the **Polarity** selection box to select + True or – True.
2. Use the **Assignment** selection box to select an input assignment. Selections are:

<b>None</b> [default]	Enter	SmartTrac	Trigger 3
Blank Display*	ID1	Tare	Unit Switching
Clear System Error Alarm	ID2	Target Pause/Abort**	Unit - Primary
Clear Tare	ID3	Target Start/Resume**	Unit - Second
Disable Keypad*	ID4	Trigger 1	Unit - Third
Disable Setup	Print	Trigger 2	Zero



\* Blank Display and Disable Keypad are designed to be activated by a simple press-and-hold or key and lock mechanism

\*\* Discrete input assignment only available when weighing in Material Transfer mode

3. Press the OK softkey  to accept the entry.
4. Press the ESCAPE softkey  to return to the Discrete Inputs screen without saving.
5. Press the DELETE softkey  to delete an input assignment.

**3.6.3.2. Outputs**

The Discrete Outputs screen displays discrete output assignments, including the output assignment address and function. Only records with non-null values display.

To clear the entire table, press the CLEAR softkey , then press OK  to confirm the action. Press the UP and DOWN navigation keys to scroll up and down the screen in order to view all of the possible discrete output assignments.

To modify, add, or delete discrete outputs, follow the same procedures described for inputs. Valid address numbers are:

I/O Module	Valid Addresses
Local 2in/5out	0.1.1, 0.1.2, 0.1.3, 0.1.4, 0.1.5
Local 5in/8out	0.1.1, 0.1.2, 0.1.3, 0.1.4, 0.1.5, 0.1.6, 0.1.7, 0.1.8
Remote #1	1.0.1, 1.0.2, 1.0.3, 1.0.4, 1.0.5, 1.0.6

Remote #2	2.0.1, 2.0.2, 2.0.3, 2.0.4, 2.0.5, 2.0.6
Remote #3	3.0.1, 3.0.2, 3.0.3, 3.0.4, 3.0.5, 3.0.6

**Examples:**

Address 0.1.1 = Local discrete board, position 1.

Address 1.0.3 = Remote address #1, position 3.

The selections for output assignments are:

None [default]	Comparator 4	Net	Tolerance - OK
Center of Zero	Comparator 5	Over Capacity	Under Zero
Comparator 1	Fast Feed*	Over Zone**	Under Zone**
Comparator 2	Feed*	System Error Alarm	Zero Requested
Comparator 3	Motion	System OK	

\* Discrete output assignment only available when weighing in Material Transfer mode

\*\* Discrete output assignment only available when weighing in Over/Under mode

**3.6.4. PAC**

When an application software module (PAC) is installed in the IND570, this area of the setup menu tree includes screens used to configure the PAC. Refer to the User's Guide for each specific application pac for details on configuration of the software.

**3.6.5. TaskExpert**

A custom TaskExpert program that has been loaded into the IND570 can be enabled from this screen. It is also used to access custom setup screens defined by the TaskExpert application.



- These TaskExpert setup screens are not accessible unless the TaskExpert function is enabled in the terminal. TaskExpert is enabled in the terminal by installing the TaskExpert Application Software key.



**3.6.5.1. Start**

The TaskExpert Start screen allows you to list your TaskExpert programs and associate each of them to a Task number. Each task can be set to run automatically at terminal power up, automatically after exiting Setup, or started manually using the Task List , Task 1, Task 2 or Task 3 softkeys.

Press the CLEAR softkey  to reset the table.

**3.6.5.1.1. To modify the TaskExpert Start list**

1. Use the arrow keys to select the existing task to be edited or deleted. With the record selected:  
 Press the EDIT softkey  to modify a record. Note that the Task number cannot be modified.  
 Press the DELETE softkey  to delete a record.

2. To create a new task press the NEW softkey . The TASK EXPERT EDIT screen will display.
3. The **Task Number** will be assigned automatically. Enter the name of the TaskExpert file in the **File Name** field.
4. Set **Auto Start** to Enabled or Disabled. If Enabled is selected, the task will run each time the indicator is powered up or when Setup is exited.
5. Set **Manual Start** to Enabled or Disabled. This will cause the program to run when manually selected and started.
6. Press  to save changes or  to exit without saving.

**3.6.5.2. Custom Setup**

The Custom Setup menu is defined by the TaskExpert application. For details, refer to the **TaskExpert Reference Manual**, provided with TaskExpert.

**3.6.6. Reset**

The Reset function returns most configuration settings in the Application branch to their factory defaults.

To initiate a reset, press the OK softkey . If the reset was successful, a verification message that reads "Reset Successful" displays. If the reset was not successful, an error message that reads "Reset Failure" displays. If the reset fails, try to initiate the reset again. If the reset continues to fail, contact a local METTLER TOLEDO representative for assistance.

Press the ESCAPE softkey  to exit without resetting.

- **Application > Reset** does NOT include the reset of information stored in Alibi Memory or tables. This data can only be reset by executing the Reset All function found at **Maintenance > Reset All**.

## 3.7. Terminal

The configuration screens for the Terminal branch of setup are shown below. If user security is enabled, Login must be at Maintenance level or above to access most parameters in the Terminal branch. A Supervisor can set the time and date.

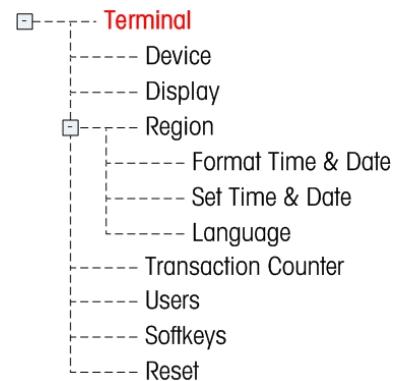

**3.7.1. Device**

The Device setup screen enables the entry of three terminal IDs and the terminal serial number.

**3.7.1.1. Terminal ID #1, ID #2, ID#3**

Up to three terminal identifiers can be entered on the Device setup screen. When the Terminal ID text box is selected, the softkeys become alpha keys. Use the alpha keys to enter up to three terminal IDs. Press the ENTER key to accept the ID entered. These ID fields display in the information recall when the SYSTEM INFORMATION softkey  is pressed after the



RECALL softkey . These IDs are also included in the Service Information Recall report and Terminal Status Report.



### 3.7.1.2. Serial Number

The Serial Number text box is used to enter the serial number of the IND570 terminal.

The terminal serial number displays in the information recall when the SYSTEM INFORMATION softkey **i** is pressed after the RECALL softkey . The serial number is populated at the factory during manufacturing. The serial number is not cleared when a Master Reset is carried out on the terminal (refer to Chapter 4, **Service and Maintenance**).







If the serial number requires re-entry (for example, if the main pcb is changed), use the alphanumeric keys to enter the terminal's serial number. The factory assigned serial number is located on the back of the terminal.

### 3.7.1.3. Connected Devices



The Connected Devices softkey provides access to a list where information on devices connected to the terminal can be stored/viewed. This list must be populated manually during the installation. Once populated, it can be viewed from this location within setup or with the Connected Devices softkey  which displays when the SYSTEM INFORMATION softkey **i** is pressed after the RECALL softkey  is pressed on the home screen.

The fields for each connected device record include Description, Model and Note.

#### 3.7.1.3.1. To Add or Modify Connected Device Records

1. Press the Connected Devices softkey  at the bottom of the Device screen.
2. Press the NEW softkey  to create a new record.
3. To edit an existing record, press the UP and DOWN navigation keys to select (highlight) a record in the list then press the EDIT softkey  to open the edit screen.
4. Press the UP and DOWN navigation keys to move the focus to the field name to be edited or inserted.
5. Press the ENTER key to select a field value to edit or insert.
6. Use the alphanumeric keypad to edit or enter the desired value.
7. Press the OK softkey  to accept the modifications or additions.
8. Press the ESCAPE softkey  to return to the Connected Devices screen without saving modifications or additions.
9. Press the EXIT softkey  to return to the Device screen.

#### To Delete or Clear Connected Device Records

1. Press the UP and DOWN navigation keys to move the focus to the record to be deleted. Press the DELETE softkey  to delete this record from the list.
2. Press the CLEAR softkey  to clear all records from the list.

3. Press the EXIT softkey  to return to the Device screen.

### 3.7.2. Display

Use the Display setup screen to configure settings for Backlight Timeout (LCD only), the Screensaver, Tare Display, Auxiliary Display and Metrology Line. A backlight adjustment softkey  is also available on this page.

#### 3.7.2.1. Backlight Timeout (LCD Display Only)

The display backlight (only available with the LCD display) can be set to turn off after a specific period of terminal inactivity, set in minutes.

#### 3.7.2.2. Screensaver

The screensaver can be activated to show a graphic or a small display of the live scale weight. The selections are:

Graphic, **Weight** [default]

A second field determines the number of minutes (from 0 to 99 – **default of 15**) that must elapse with no scale motion and no keypad activity before the screensaver is shown. A setting of "0" in this number of minutes field will disable the screensaver.

During runtime, if motion is detected on the scale or any key is pressed, the screen saver automatically stops and its timer is reset. The keystroke used to exit the screen saver mode is ignored for all other purposes.

- If the scale is programmed as "approved", the screensaver will only operate when the scale is at gross zero.

##### 3.7.2.2.1. Changing the Screen Saver Graphic

The graphic used by the IND570 as a screen saver can be changed by downloading a replacement file to the terminal.

#### Screen Saver Graphic Specification

The screen saver graphic is a monochrome bitmap file that should measure no more than 128 pixels wide by 44 pixels high. The graphic must have a white boarder at least one pixel wide at the left, right and top. The maximum size of the bitmap file cannot exceed 1.5 KB. The bitmap must be named saver.bmp for correct use in the IND570.

- **Note:** Bitmap files must be black and white in order to display correctly on the terminal screen.

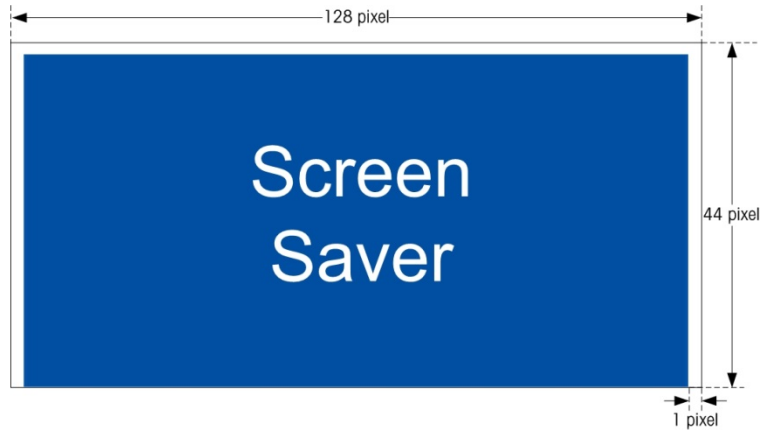

**Figure 3-14: Screen Saver Graphic**

### Installing New Graphic

The screen saver graphic can be installed on the IND570 by making a serial file transfer or by using an ftp connection to the terminal via Ethernet, logging on as an administrator (with write privileges), and copying the file to ram:\saver.bmp. Refer to the FTP section of Appendix C, **Communications**, for further details.

### 3.7.2.3. Tare Display

This setting determines whether the tare display is shown on the home screen when the largest size weight display is shown. The tare display is not available when Auxiliary display is enabled. Display options for the tare display include:

Disabled	The tare value will not be shown in the weight display
<b>Active</b> [default]	The tare value is shown on the largest weight display only when a tare has been taken. In the gross mode, no tare value is shown.
Always	There is a reserved space on the largest weight display for the current tare value. In the gross mode, the tare is shown as zero.

### 3.7.2.4. Auxiliary Display

A SmartTrac™, Rate or Discrete I/O status display can be displayed on the home screen in addition to the weight. The weight display changes size to accommodate the auxiliary display selection.

The choices for Auxiliary Display are:

**Disabled** [default], DI/O Status, Rate, SmartTrac–Small, SmartTrac–Medium, SmartTrac–Large.

When Rate or DI/O Status is selected for the auxiliary display, the weight display is shown in half size and the auxiliary display is shown below the weight. The number of DI/O inputs and outputs shown will match the number of inputs and outputs of the internal I/O option installed in the terminal.

SmartTrac™ refers to a graphical visualization used to represent measured values. The display is either a bar graph (if material transfer is selected as the target mode) or an over/under display (if over/under is selected as the target mode). SmartTrac graphics also vary in terms of the amount of data displayed. While the SmartTrac graphic remains constant in size, the “small” setting includes minimal information, while the “large” setting displays the description as well as the target and

tolerance values. Refer to the **SmartTrac** section in Chapter 2, **Operation**, for examples of the different SmartTrac graphics.

The SmartTrac selections will only be shown if target table Mode has been selected as either Material Transfer or Over/Under.

For the SmartTrac to display on the home screen when the SmartTrac <sup>Smart</sup>-Trac soffkey is pressed, auxiliary display must be programmed as SmartTrac and an active target ⊕ must be programmed. If both of these conditions are not met, "Function Disabled" will be shown when the SmartTrac soffkey is pressed.

3.7.2.4.1. SmartTrac Size

SmartTrac refers to a graphical display visualization used to represent measured values. The display is either a bar graph (if material transfer is selected as the target mode) or an over/under display (if over/under is selected as the target mode).

The graphical display varies in terms of the amount of data displayed. While the SmartTrac graphic remains constant in size, the "small" setting includes minimal information, while the "large" setting displays the description as well as the target and limit values.

Examples of different sizes of SmartTrac displays are as follows:

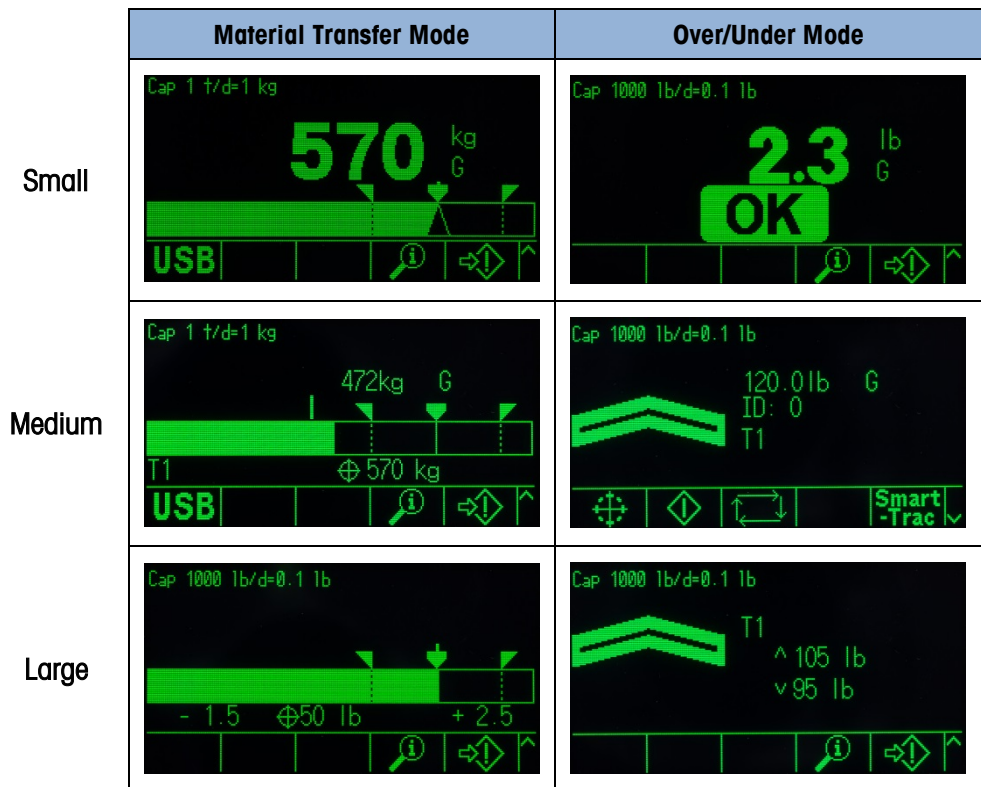

Figure 3-15: SmartTrac Display Sizes, Material Transfer and Over/Under Modes

### 3.7.2.5. Metrology Line

A metrology line that displays programmed capacity and increment information or Max/Min/e information can be enabled. The selections are:

Disabled, **Cap/d** [default], Max/Min/e

This metrology line may serve to meet the metrological display requirements of various regions in the world. In case the metrology date line is not accepted by an agency, it can be disabled and a label with the required information may be installed near the display. Refer to the **IND570 Installation Manual**, for more details.

### 3.7.2.6. Backlight Adjustment

If an LCD-type display is detected, a Backlight Adjustment softkey  appears in position 3. Press this softkey to display the backlight adjustment screen.



**Figure 3-16: Backlight Adjustment Screen**

Press the Darker  and Brighter  softkeys to adjust the backlight.

### 3.7.3. Region

The region setup screens enable configuration of the time and date, the language for messages, the gross weight symbol used on the display and whether a comma or decimal will be used in weight values transmitted or printed from the terminal.

#### 3.7.3.1. Format Time & Date

Selection boxes on this setup screen enable formatting of the time and date and the date field separator character.

##### 3.7.3.1.1. Time Format

Possible selections are:

12:MM	12-hour clock with hour and minutes displayed
12:MM:SS	12-hour clock with hour, minutes, and seconds displayed
24:MM	24-hour clock with hour and minutes displayed
<b>24:MM:SS</b> [default]	24-hour clock with hour, minutes, and seconds displayed

##### 3.7.3.1.2. Date Format

Possible selections are:

DD MM YY	Two-digit day, month, year
<b>DD MMM YYYY</b> [default]	Two-digit day, three-character month, four-digit year
MM DD YY	Two-digit month, day, year
MMM DD YYYY	Three-character month, two-digit day, four-digit year
YY MM DD	Two-digit year, month, day
YYYY MMM DD	Four-digit year, three-character month, two-digit day

3.7.3.1.3.

Date Field Separator

Possible choices include:

None, / (**slash**) [default], - (dash), . (period), (space)

**3.7.3.2.**

**Set Time & Date**

Enter the hour, minutes, day, month, and year on this setup screen's text fields and selection boxes. The terminal automatically adjusts the date for a leap year, and a battery backup maintains the time and date settings in the event of a power outage.

When needed, the time must be manually adjusted for daylight savings time. The IND570 does not make this adjustment automatically.

3.7.3.2.1.

Hour

Use the numeric keypad to enter the hour in the Hour field text box. If the time format is set to 12:MM or 12:MM:SS on the Format Time & Date setup, **AM** [default] or PM must be selected.

3.7.3.2.2.

Minutes

Use the numeric keypad to enter the minutes in the Minutes field text box.

3.7.3.2.3.

Day

Use the numeric keypad to enter the day in the Day field text box.

3.7.3.2.4.

Month

Use the Month selection box to select the month.

3.7.3.2.5.

Year

Use the numeric keypad to enter the year in the Year field text box.

**3.7.3.3.**

**Language**

Use the Language setup screen to specify the language, gross weight legend and decimal/comma character for the terminal.

3.7.3.3.1.

Display Messages

Use the Display Messages selection box to select the language for messages that display on the terminal. Choices are:

**English** [default], French, German, Italian, Polish, Portuguese, Russian, Spanish, Chinese, Custom

#### 3.7.3.3.2. Keypad Selection

Use the Keypad Selection box to select the language for the keypad alpha characters that are available on the terminal. Choices are:

**English** [default], Global, Russian

If Russian is selected, Cyrillic characters will be available via the softkeys. The global characters will continue to be available via the numeric keys.

#### 3.7.3.3.3. External Keyboard

Use this parameter to select the language for the external USB keyboard if one will be used. The language choices are:

**English** [default], French, German, Italian, Spanish

#### 3.7.3.3.4. Comma/Decimal

Use this parameter to indicate if a comma or decimal point will be used for weight values in demand data outputs. Choices are:

Comma, **Decimal point** [default]

#### 3.7.3.3.5. Gross Legend

This parameter determines what character or characters will be shown on the display to indicate a gross weight field. Typical characters are "G" for gross [default] or "B" for bruto/brutto. A maximum of three characters can be entered.

### 3.7.4. Transaction Counter

Use the Transaction Counter setup screens to configure transaction counter operations.

The transaction counter is a seven-digit register that tracks the total transactions that are completed on the terminal with a demand print output. When the value reaches 1,500,000, the next transaction causes a roll-over to 0000001. Access to this feature is granted through the setup menu or the Transaction Counter softkey **123** which can be added to the home page (refer to section 3.7.6). Use the Transaction Counter setup screen to configure transaction counter operations.

#### 3.7.4.1. Transaction Counter

Use the Transaction Counter selection box to enable or disable the transaction counter. Choices are:

Disabled, **Enabled** [default]

#### 3.7.4.2. Counter Reset

This step is shown only if the Transaction Counter has been enabled. Use the Counter Reset selection box to permit manual reset of the counter or manual entry of a starting number. Choices are:

**Disabled** [default], Enabled

### 3.7.4.3. Next Transaction

The value for the counter for the next transaction displays in the Next Transaction field. If Counter Reset is enabled, a value between 1 and 1,500,000 can be manually entered here. The counter can also be reset to 0000001 by pressing the RESET softkey  on this page or from the home page through the Transaction Counter.

### 3.7.5. Users

Security access to the IND570 is divided into four user groups: Operator, Supervisor, Maintenance and Administrator. By default, the IND570 terminal is pre-configured with two usernames: "admin" and "anonymous". The two default usernames cannot be deleted, but passwords may be entered for them.



By default, neither of these usernames has a password. Without passwords, security is disabled and there are no security challenges when attempting to make changes to configuration or access functions through softkeys. Without a password on the default "admin" account, all features are accessible to every user.

As soon as a password is entered on the default "admin" username, user security is enabled in the terminal and a login will be required before changes can be made in setup and before certain softkey functions can be executed. Up to a maximum of 20 users can be stored in the terminal. A minimum of one and a maximum of 12 characters can be entered for both the Username and the Password. Refer to the **User Security** section of Chapter 2, **Operation** and Appendix A, **Default Settings**, for additional information on user security.

#### 3.7.5.1. To Enter a New Username and Password

1. Press the NEW softkey  to access the User Edit screen.
2. Enter the desired username in the Username field.
3. Use the Access selection box to assign the appropriate access level to the user. The following access levels are available:



Administrator	An Administrator level has access to all setup parameters. Turning the "Legal for Trade" switch (SW1-1) ON will reduce all Administrator level users to Maintenance level.
Maintenance	Next lower level of access.
Supervisor	Next lower level of access.
Operator	Lowest level of access.

4. Enter the desired password in the Password and Confirm Password fields.
  5. Press the OK softkey  to accept the username and password as entered.
  6. Press the ESCAPE softkey  to exit without saving the username and password.
- Passwords are case-sensitive.
  - All numbers and all characters available in the alphanumeric keys are valid for use in passwords.





- Be sure to store a record of user passwords in a safe place. Without a correct password for an administrator level account, full access to the setup menu will not be possible.

### 3.7.5.2. To Modify and/or Enter A Password for a Username

1. Move focus to the username to be edited.
2. Press the EDIT softkey  to access the User Edit screen.
3. Press the DOWN navigation key to view the second screen, which displays the Password and Confirm Password fields.
4. Enter the desired password in the Password and Confirm Password fields.
5. Press the OK softkey  to accept the password as entered.
6. Press the ESCAPE softkey  to exit without saving the password.

### 3.7.5.3. To Delete a User or Clear All Users

1. Press the DELETE softkey  to delete a username from the table on the Users screen. Usernames "admin" and "anonymous" cannot be deleted.
2. To restore the factory default setting (by deleting all users except the "Admin" and "Anonymous" users and restoring the passwords to null), press the CLEAR softkey  and then  to confirm the action.

## 3.7.6. Softkeys

Add or rearrange the display of softkeys on the main weighing screen by configuring parameters on the softkey setup screen.

Adding a softkey to the home pages of the terminal does not automatically enable the softkey function. Most functions associated with softkeys must also be enabled in setup. For instance, adding the UNITS SWITCHING softkey  does not automatically enable units switching – a second or third unit must also be enabled in the Scale branch of setup. If a softkey has been added in setup but does not appear on the home page, check that the setup parameters for that function have been enabled.

- If an entire row of softkeys is blank, then that row will not be made available at the home screen. For example, if softkey positions 1–5 have softkeys programmed and positions 11–15 have softkeys programmed but softkey positions 6–10 are blank, the second row of softkeys will not be shown from the home screen.

The following softkeys are available for assignment to the home page:

- For a comprehensive list of all available softkey icons with descriptions, refer to Chapter 2, **Operation**.

None	Recall Info*	Task 3**
Alibi	Repeat Print	Task List**
Backlight Adjustment	Reports	Time & Date
Calibration Test	Setup*	Totalization

Comparators	SmartTrac	Transaction Counter
GWP Test	Tare Table	Trigger 1
ID1	Target	Trigger 2
ID2	Target Control	Trigger 3
ID3	Target Start	Unit Switching
ID4	Target Table	USB
MinWeigh	Task 1**	x10 Display
PWCL Performance Log***	Task 2**	

\* Cannot be removed from home screen.

\*\* Only available when TaskExpert™ is installed.

\*\*\* Only available in POWERCELL versions.

### 3.7.6.1. Editing Softkeys

When the softkeys setup screen opens, focus is on the softkey position number "1" located above the first icon (see Figure 3-17).









**Figure 3-17: Softkeys Setup Screen**

The focus can be moved by pressing the UP, DOWN, LEFT, and RIGHT navigation keys. As a different softkey position gains the focus, its assignment is shown in text toward the bottom of the screen.

For example, in Figure 3-17 focus is on softkey position number 1, which is assigned the UNIT SWITCHING softkey . Press the RIGHT navigation key twice to move focus to softkey position 3. The assignment value changes to the REPORTS softkey .

Two softkeys, INFORMATION RECALL and SETUP , must always be present. As a default, they are located together in positions 9 and 10. These keys can be moved by first creating a copy of the softkey in a new position and then deleting the softkey from the original position. The original assignment cannot be removed until the new position has been created.



Press the UP, DOWN, LEFT and RIGHT navigation keys to navigate among the softkey position numbers until the required softkey number is in focus. Softkeys can be added, removed, and positioned using the softkeys:

	<b>Edit</b>	Changes the soffkey in the selected position to another soffkey or to none, which leaves the soffkey position blank. Editing a blank position does not move the position of following soffkeys.
	<b>New</b>	Inserts a soffkey into a selected position. All other soffkeys located at or after that position increase position number by one.
	<b>Delete</b>	Deletes a soffkey in a selected position. All other soffkeys located at or after that position decrease position number by one.
	<b>Clear</b>	Clears all soffkey assignments except INFORMATION RECALL  and SETUP  soffkeys. These will be shown in positions 1 and 2 respectively.

#### 3.7.6.1.1. Inserting Soffkeys

- When a soffkey is inserted, all soffkeys in positions after the selection insertion point will be shifted one space to the right.

##### To Insert a Soffkey

1. Use the navigation keys to move the focus to the position number where the soffkey is to be inserted.
2. Press the INSERT soffkey . The Soffkey Edit screen displays. The soffkey position selected is shown on the screen along with Assignment selection box.
3. Press the ENTER key to select the assignment selection box.
4. Use the UP or DOWN navigation keys to scroll through the selections until focus is on the desired assignment.
5. Press the ENTER key to select the assignment. If None is selected for the assignment, the soffkey assignment is reserved as a blank space.
- If all 15 soffkey positions are full and a new soffkey is added, all positions after the inserted position will move one position to the right and the soffkey in position 15 will be lost. The only exception to this is if the RECALL or SETUP soffkeys are in position 15, the soffkey immediately before these special soffkeys will be lost.
6. Press the EXIT soffkey  to return to the Soffkeys Setup Screen. The new soffkey will display on the Soffkey setup screen in the position where it was inserted and all following soffkeys will be moved one position to the right.

#### 3.7.6.1.2. Editing Soffkeys

The edit function allows one soffkey assignment to be replaced with another. Use this function to replace a blank assignment with another soffkey assignment, without moving any other soffkey positions.

##### To Edit a Soffkey

1. Use the navigation keys to move the focus to the position number of the soffkey to be edited.
2. Press the EDIT soffkey . The Soffkey Edit screen (Figure 3-18) displays. The soffkey position number selected for editing is shown on the screen, together with the soffkey's current assignment – or **None**, if no soffkey is assigned.

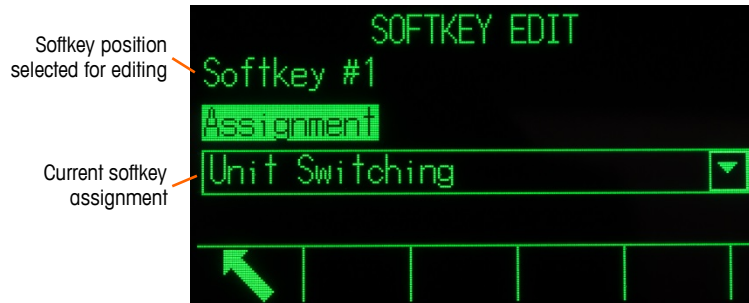

**Figure 3-18: Softkey Edit Screen**

3. Press the ENTER key to select the assignment selection box.
  4. Use the UP or DOWN navigation keys to scroll through the selections until focus is on the desired assignment.
  5. Press the ENTER key to select the assignment. If **None** is selected for the assignment, the softkey assignment is reserved as a blank space.
  6. Press the EXIT softkey  to return to the Softkeys Setup Screen.
- There is no limit on the number of positions that can have the same softkey assignment. For example, a softkey can be assigned to a position in each of the three available rows, so that it is always visible and available for use.





#### 3.7.6.1.3. Deleting Softkeys

- When a softkey assignment is deleted, all softkeys to the right of the deleted key will move one position to their left.

##### To Delete a Softkey

1. Use the navigation keys to move the focus to the position number of the softkey to be deleted.
  2. Press the DELETE softkey . The softkey will disappear from the Softkey setup screen, and all following softkeys will be moved one position to the left.
- Remember that there must always be one instance each of the RECALL and SETUP softkeys. The original softkey cannot be deleted until a new position has been created.

#### 3.7.6.1.4. Clearing All Softkeys

To clear all softkey assignments except INFORMATION RECALL  and SETUP , press the CLEAR softkey . A screen will display requesting confirmation of the action. Press the OK softkey  to continue, or the ESCAPE softkey  to return to the Softkeys setup screen.

#### 3.7.6.2. Customizing Softkeys

All the softkeys available for assignment to the home screen can be replaced with customized bitmap images.

The bitmaps must measure no more than 48 pixels wide by 24 pixels high. Each graphic must have a white border at least one pixel wide at left, right and top – see Figure 3-19.

- Note: Bitmap files must be black and white in order to display correctly on the terminal screen.

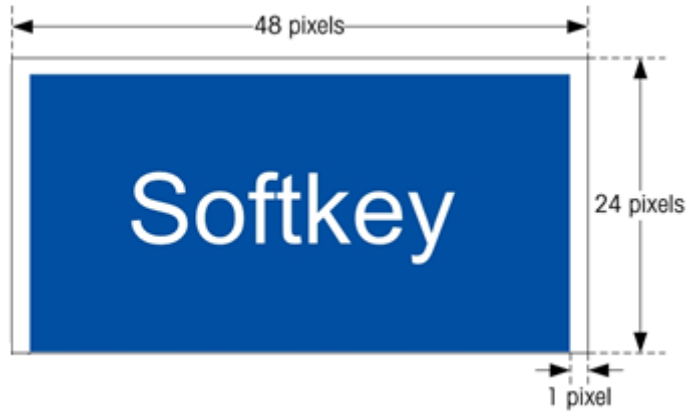

**Figure 3-19: Softkey Graphic Dimensions**

Graphics may be uploaded to the **Flash2:\** folder of the IND570 terminal using an ftp connection via Ethernet, or through a serial port. Refer to Appendix D, **Communications**, for details on the file transfer procedure.

New bitmap graphics must have the same filename as the graphic they replace. Table 3-8 lists the softkey graphics that can be replaced with customized images.

**Table 3-8: Bitmap Graphic Filenames**

Softkey	Default Image	Graphic File Name
Alibi	<b>Alibi</b>	alibi.bmp
Backlight Adjustment		contrast.bmp
Calibration Test		cal_test.bmp
Comparators		comprtr.bmp
GWP	<b>GWP</b>	GWP.bmp
ID1	<b>ID 1</b>	ID1.bmp
ID2	<b>ID 2</b>	ID2.bmp
ID3	<b>ID 3</b>	ID3.bmp
ID4	<b>ID 4</b>	ID4.bmp
MinWeigh	<b>Min-Weigh</b>	minweigh.bmp
Recall Info		recall.bmp
Repeat Print		rpt_prnt.bmp
Reports		reports.bmp
Setup		setup.bmp
SmartTrac	<b>Smart-Trac</b>	sm_trac.bmp
Tare Table		tare_mem.bmp
Target		target.bmp
Target Control		control.bmp

Softkey	Default Image	Graphic File Name
Target Start		start.bmp
Target Table		targ_mem.bmp
Task List		tasklist.bmp
Task 1, Task 2, Task 3		task1.bmp, task2.bmp, task3.bmp
Trigger 1		trigger1.bmp
Trigger 2		trigger2.bmp
Trigger 3		trigger3.bmp
Time & Date		timedate.bmp
Totals Recall		tot_mem.bmp
Transaction Counter		reset.bmp
Unit Switching		select.bmp
USB	<b>USB</b>	usb.bmp
X10 Display	<b>x10</b>	x10.bmp

### 3.7.7. Reset

The Reset setup screen resets setup values to factory default settings for the Terminal branch of setup.

To initiate a reset, press the OK softkey . If the reset was successful, a verification message that reads "Reset Successful" displays. If the reset was not successful, an error message that reads "Reset Failure" displays. If the reset fails, try to initiate the reset again. If the reset continues to fail, contact a local METTLER TOLEDO representative for assistance.

Press the ESCAPE softkey to exit without resetting.

## 3.8. Communication

Configuration of the following functions is managed in the Communication block of setup.

### 3.8.1. Access/Security

By default, access to the IND570 through the Ethernet and USB ports is limited. Selections made in the Access/Security parameters determine the level of access to files and data that will be allowed.

#### 3.8.1.1. Ethernet

Access to the terminal Shared Data Server, Web Server and FTP function are selected at this branch of setup.

##### 3.8.1.1.1. Shared Data Server

This setting determines access to the Shared Data Server over an Ethernet connection. Choices are:

**Read/Write** [default], Read Only, Disabled

##### 3.8.1.1.2. Web Server

Web Server access must be set equal with or below the access level selected for the Shared Data Server. Choices are:

**Disabled** [default], Read/Write, Read Only

##### 3.8.1.1.3. FTP (File Transfer Protocol)

Choices are:

Disabled, **Read/Write** [default], Read Only

#### 3.8.1.2. USB

Connected USB device function and access to the USB file transfer function are selected here. USB devices will not be recognized when connected until the following functions are enabled.

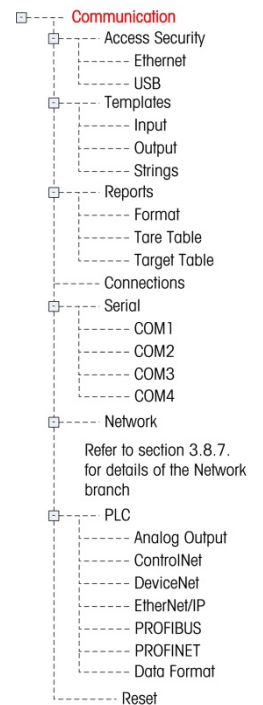

	WARNING
	THE USB INTERFACE IS NOT CERTIFIED FOR USE IN DIVISION 2 OR ZONE 2/22 HAZARDOUS AREAS. USE ONLY IN SAFE AREA.

##### 3.8.1.2.1. Keyboard and Scanner

Choices are:

**Disabled** [default], Enabled

3.8.1.2.2. Memory Stick  
 Choices are:

**Write Only** [default], Disabled, Read/Write

### 3.8.2. Templates

The input template function allows the IND570 to receive a string input (such as from a bar code scanner) and use it as data entry for a TaskExpert application, an ID data collection field, preset Tare weight, or selection of a stored Tare ID or Target ID. When the Fill-570 Application Software is installed, the input template can also be used for selection of the target for Weigh-In or Weigh-out.

The IND570 terminal supports ten output templates (1,000 bytes in size) that can be used to define the format of on demand or continuous data outputs.

The template Strings setup supports creation and storage of character strings that are frequently used in templates. Creating and storing frequently used character strings decreases the time it takes to create output templates through the terminal HMI.

### 3.8.3. Input

Use the Input Template to strip unneeded characters from an incoming string of data and identify only the specific data needed for a function. Input template setup parameters include the following.

3.8.3.1.1. Preamble Length

Defines how many characters are skipped at the beginning of an input string before the desired data is identified. Values from 0 to 255 can be entered.

3.8.3.1.2. Data Length

Defines the length of the data to be extracted from the incoming string. All characters beginning after the preamble through the data length selection are used as the input. Values from 1 to 40 are accepted.

3.8.3.1.3. Postamble Length

Defines the number of characters (before but not including the termination character) that will be stripped off the end of the incoming data string. When using an input that is always the same fixed length, this field remains blank. Values from 0 to 255 are accepted.

All characters after the preamble length to the termination character minus the postamble length are used as the input data string.

3.8.3.1.4. Termination Character

Used to signal the end of the string input. The termination character can be any ASCII control character. Selections for Termination Character include:

None	EOT	BS	FF	DLE	DC4	CAN	FS
SOH	ENQ	HT	<b>CR</b> [default]	DC1	NAK	EM	GS
STX	ACK	LF	SO	DC2	SYN	SUB	RS
ETX	BEL	VT	SI	DC3	ETB	ESC	US



- If None is selected, the entry is terminated after a three-second timeout. There is also a three-second timeout feature that tracks the amount of time between incoming characters. Even if a terminal character is selected, if three seconds elapses between character receipt, the string is considered terminated.

#### 3.8.3.1.5. Assignment

This parameter determines how the input data should be used. Choices are:

Application	Data is available in Shared Data for use by a custom TaskExpert program
ID Response 1	Input populates the first response to the ID1 sequence
Keypad	Data that would normally be entered using the alphanumeric keypad may be scanned in with this setting
<b>Tare</b> [default]	Enters data as a preset tare value
Tare ID	Uses incoming value as an ID lookup in the tare table
Target ID	Uses incoming value as an ID lookup in the target table
Target Weigh-in	Uses incoming value as an ID lookup in the target table and assigns it as the Active Weigh-in target (Fill-570 feature only)
Target Weigh-out	Uses incoming value as an ID lookup in the target table and assigns it as the Active Weigh-out target (Fill-570 feature only)

#### 3.8.3.2. Output

The Output Template setup screen enables configuration of the output data formats and the location of the "Duplicate" text for the Repeat Print function.

##### 3.8.3.2.1. Template

Select the template number to be viewed, modified, copied or cleared in the selection box. Choices include:



**Template 1** [default] to Template 10

##### 3.8.3.2.2. Repeat Print Field

To add the "DUPLICATE" designation to a repeat print of an output template. Choices are:

<b>Disabled</b>	The text "DUPLICATE" will not be added to a repeat print
Footer	The text "DUPLICATE" is added as a new last line in the template format for a repeat print
Header	The text "DUPLICATE" is added as a new first line in the template format for a repeat print

##### 3.8.3.2.3. Copy a Template:

1. To copy one template as the beginning point for another template, press the COPY softkey .
2. A new screen is shown to select the template to be copied from and the template to be copied to.
3. Make the appropriate choices in the selection boxes then press the OK softkey  to perform the copy.

4. Pressing the ESCAPE softkey **Esc** will exit without making a copy.

3.8.3.2.4. Clear a Template:

1. Select the template to be cleared in the Template selection box.
2. Press the CLEAR softkey **C** to clear all elements from the selected template.
3. A warning screen displays as a precaution. Press the OK softkey **OK** to clear or press the ESCAPE softkey **Esc** to exit without making any changes.

3.8.3.2.5. View, Edit, or Print a Template

Press the VIEW TABLE softkey **VIEW** to access the selected template's view screen, which lists each element configured for the template and includes action softkeys.

Each element is defined by the data type, actual data, justification and length. Elements may be edited, added (inserted), or deleted individually. A leading zero fill function is available for certain fields.

**Editing**

1. Press the UP and DOWN navigation keys to select an entry to edit.
2. Press the EDIT softkey **EDIT** to open the setup screen for the record where edits can be made. The element number cannot be edited.
3. Select the element type from the Type selection box. Four element types are available:
 

CR/LF	Combination carriage return and line feed used to terminate a line.
SDName	Name of a Shared Data Variable from the terminal that includes the data for the template
Special Character	Insert a control character into the template.
String	A string of characters to print
4. Press ENTER to confirm the element type selection. Depending on which type is selected, additional configuration options will appear.
5. Press the OK softkey **OK** to return to the template setup screen when editing of the element is complete.
6. Press the ESCAPE softkey **Esc** to return to the template setup screen without saving the element edits.

3.8.3.2.6. Template Editing Options

Table 3-9 lists the editable fields that appear for each Element Type and Format selection. Fields that are not available are indicated with a dash (-).

**Table 3-9: Template Element Editing Options**

Element Type	Data	Repeat Count	Format	Length	Leading Zero Fill
CR/LF	-	Blank**	-	-	-
SDNAME	Blank*	-	Default	-	-

Element Type	Data	Repeat Count	Format	Length	Leading Zero Fill
	(Refer to Table 3-10)		Centered, Left	Blank**	–
			Right	Blank**	Enabled/Disabled
Special Character	ASCII character list	–	–	–	–
String	Blank*	Blank**	Default	–	–
			Center, Left, Right	Blank**	–

\* Alphanumeric entry field

\*\* Numeric entry field

### Repeat Count

A numeric value that sets the number of times the Data will repeat. For example, if the string data entered is an asterisk (\*), a repeat count value of 20 would produce a row of 20 asterisks:

\*\*\*\*\*

### Format & Length

The Format & Length options are Default, Centered, Left, and Right. These describe the justification of the data within the length of the field.

The Default value is fixed, and Length cannot be defined here.

For SD name and String data, the Centered, Left and Right formats are accompanied by a Length field. After choosing the format, focus moves to the Length entry box. This value determines how long the element will be – the data will be positioned within a string of the length entered. Refer to the Notes on Format & Length, below.

### Leading Zero Fill

In the case of Right-formatted SDName data, Leading Zero fill may be enabled or disabled. Normally, Leading Zero Fill will be disabled, which means spaces will be used to fill in leading non-significant data. If enabled, Leading Zero Fill will fill in any leading spaces of the data with zeroes. The following examples of 4 characters in output data defined as 8 characters long show the use of Leading Zero Fill:

Leading Zero Fill disabled: 

				.	1	2	3
--	--	--	--	---	---	---	---

Leading Zero Fill enabled: 

0	0	0	0	.	1	2	3
---	---	---	---	---	---	---	---

### Notes on Format & Length

If data for an element includes more characters than the value entered for Length, the output data will be cut off. For example, if the number of characters entered under format on the Output Template Edit Screen is six, and data for a string that contains eight characters is entered, only six of the characters from the data string will print. If data for a string that contains four characters is entered, all of the characters from the data string will print.

The characters and alignment of the printed data are defined by the selected format:

Example 8-character string of ABCDEFGH in a 6-character element:

Center:

B	C	D	E	F	G
---	---	---	---	---	---

Prints the middle six characters from an eight-character string – drops first and last characters.

Left:

A	B	C	D	E	F
---	---	---	---	---	---

Prints the first six characters from an eight-character string – drops the last two characters.

Right:

C	D	E	F	G	H
---	---	---	---	---	---

Prints the last six characters from an eight-character string – drops the first two characters.

Example 4-character string of ABCD in a 6-character element:

	A	B	C	D	
--	---	---	---	---	--

Space                      Space

Prints all four characters from a four-character string in a centered position, leaving a space at the beginning and a space at the end.

A	B	C	D		
---	---	---	---	--	--

Spaces

Prints all four characters from a four-character string in a left-justified position, leaving two spaces at the end.

		A	B	C	D
--	--	---	---	---	---

Spaces

Prints all four characters from a four-character string in a right-justified position, leaving two spaces at the beginning.

In Table 3-10, where dashes appear in the SDName (e.g. sd--08), this means that there are more than one instance of the share data variable. The instance number appears in place of the dashes (e.g. sd0308, for the third comparator's target comparison operator). For a full list of Shared Data fields, please refer to the **IND570 Terminal Shared Data Reference** (document # 64058660), available for download at [www.mt.com/IND570](http://www.mt.com/IND570).

**Table 3-10: Example Shared Data Names for Use in Templates**

IND570 Data Field	SDName	Length (A/N = alphanumeric)
<b>Terminal</b>		
Scale ID	cs0103	20 A/N
Base Serial Number	ce0138	13 A/N
Terminal Serial Number	xs0105	13 A/N
Terminal ID#1	xs0106	20 A/N
Terminal ID#2	xs0107	20 A/N
Terminal ID#3	xs0108	160 A/N
Current Date	xd0103	11 A/N
Current Time	xd0104	11 A/N
Transaction Counter Value	xp0101	9 A/N
Grand Total Value	tz0101	12 A/N
Grand Total Count	tz0102	9 A/N
Subtotal Value	tz0103	12 A/N
Subtotal Count	tz0104	9 A/N

<b>IND570 Data Field</b>	<b>SDName</b>	<b>Length (A/N = alphanumeric)</b>
ID1 Prompts 1-30	pr0131-pr0160	30 A/N
ID1 Prompt Responses 1-30	pa0101-pa0130	51 A/N
ID2 Prompts 1-30	pr0231-pr0260	30 A/N
ID2 Prompt Responses 1-30	pa0201-pa0230	51 A/N
ID3 Prompts 1-30	pr0331-pr0360	30 A/N
ID3 Prompt Responses 1-30	pa0301-pa0330	51 A/N
ID4 Prompts 1-30	pr0431-pr0460	30 A/N
ID4 Prompt Responses 1-30	pa0401-pa0430	51 A/N
Message 01, 02, etc.	aw0101, 0102,...	100 A/N
Templates 1 - 10*	pt0101 – pt0110	As programmed
Template Strings 1–20	pt0111 – pt0130	51 A/N
<b>Targets</b>		
Target Description	sp0101	20 A/N
Target Value	sp0105	12 A/N
Target Units	sp0120	3 A/N
Fine Feed	sp0110	12 A/N
Spill Value	sp0109	12 A/N
+ Tolerance Value (weight)	sp0111	12 A/N
– Tolerance Value (weight)	sp0112	12 A/N
+ Tolerance Value (%)	sp0114	12 A/N
– Tolerance Value (%)	sp0115	12 A/N
Comparator names 1-5	sd--01	21 A/N
Comparator target coincidence values 1 – 5	sd--05	12 A/N
Comparator target comparison operators 1-5	sd--08	5 A/N
Comparator second weight range values 1-5	sd--09	12 A/N
Comparator second weight range comparison operators 1-5	sd--10	5 A/N
<b>Weights</b>		
Scale Mode (Gross/Net)	ws0101	1 A/N (G or N)
Tare Source Description	ws0109	2 A/N "T<space>", or "PT"
Displayed Tare Wt.	ws0110	12 A/N
Displayed Gross Wt.	wt0101	12 A/N
Displayed Net Wt.	wt0102	12 A/N
Displayed Wt. Units	wt0103	3 A/N
3 <sup>rd</sup> Weight Unit Gross Weight	wt0104	13 A/N

IND570 Data Field	SDName	Length (A/N = alphanumeric)
3 <sup>rd</sup> Weight Unit Net Weight	wt0105	13 A/N
3 <sup>rd</sup> Units	wt0106	3 A/N
Displayed Rate	wt0108	13 A/N
Rate Time Units	cs0107	1 A/N
Rate Weight Units	cs0108	1 A/N
Custom Unit Name	cs0112	12 A/N
Custom Unit Conversion Factor	cs0113	12 A/N
Calculated Weight**	ws0132	1 A/N

\* Using a template field code within another template will insert the entire template into the new template.

\*\* Used in multi-interval scales to indicate that the gross weight is calculated, and mathematically incorrect. In a multi-interval scale, the resolution of increments differs for each interval – for example, 0 – 5 kg, 0.0005, >5 kg, 0.001; thus, the sum of the tare and net weights will not precisely equal the gross weight. The ws0132 variable should be added to the template, and appears as a letter “C” after the weight unit – e.g. “5.304 kg C”.

### Printing Multiple Weight Units

Note that if a third weight unit is defined, it can be named in a template so that it appears in the output data together with the displayed unit. However, if the third unit is currently displayed on the terminal, it will appear twice in the data output. Therefore, if the output is to include both primary and 3<sup>rd</sup> weight units, ensure that the primary unit data is displayed when the data output is initiated.

- Secondary Units are not available for multiple unit printing.

### Inserting

Press the UP and DOWN navigation keys to select a location in the list of elements to insert a new template element. Press the NEW softkey  to open the setup screen to create a new record. Configure the parameters as described under Editing. All following elements are moved down one position.

### Deleting

Press the UP and DOWN navigation keys to select an element to delete. Press the DELETE softkey  to delete the element.

### Test Printing

Press the TEST PRINT softkey  to perform a test print of the template being configured.

#### 3.8.3.2.7. Strings



The Template Strings setup screen defines strings of characters that are frequently used in output template messages. Template strings can be viewed, edited, created, deleted, or printed.

### Viewing Template Strings



1. Use the Search Field selection box to select ID or String and enter information in the Data field to limit the search, or do not enter any search limits to view all template strings.
2. Press the START SEARCH softkey . The String Search View screen displays the search results. Only records with non-null values display. Records are ordered by ID, with the lowest ID number shown first.
3. Press the UP and DOWN navigation keys to scroll up and down the screen in order to view all strings listed.

### Editing

Note that not all keyboard characters are available when entering information using the IND570 keypad. However, characters such as the “|” (pipe) can be included in a template created using the InSite™ CSL software. They will be recognized by the IND570 when the template is downloaded, will display correctly, and will be included in the template when it is printed.

1. Press the UP and DOWN navigation keys to select (highlight) the string record to be edited.
2. Press the EDIT softkey  to open the record for editing. The edit screen will be shown with focus on the “Text” label. This is the only editable field on the screen. The ID number cannot be changed.
3. Press ENTER to access the text field.
4. Use the alphanumeric keypad to edit the string. A string can be a maximum of 50 characters.
5. Press ENTER when complete.
6. Press the OK softkey  to accept the edited record and return to the String Search View screen.
7. Press the ESC softkey  to return to the String Search View screen without accepting the changes to the string.

### Creating



1. Press the NEW softkey  to create a new record. An edit screen will be shown with “ID” and “Text” labels.
2. Press the UP and DOWN navigation keys to select the field to enter.
3. Press ENTER to access the field. When entering the ID field, the value shown is the first unused ID.
4. Use the numeric keypad to enter an ID number from 1 to 20.
5. Press ENTER when complete. If the ID entered already exists, an error display will be shown. The error must be acknowledged and a new ID entered.
6. If the TEXT field is entered, use the alphanumeric keypad to edit the text string.
7. Press ENTER when complete.
8. Press the OK softkey  to accept the new record and return to the String Search View screen.

9. Press the ESC softkey **Esc** to return to the String Search View screen without accepting the new record.

**Deleting**

Press the DELETE softkey  to delete a template string from the list.

**Printing**

1. Press the PRINT softkey  to print the list.
2. Press the EXIT softkey  to return to the String Search Screen. Press the EXIT softkey  again to return to the menu tree.

**3.8.4. Reports**

The reports setup screens enable configuration of the structure of tare and target table reports that are generated by the IND570 terminal. When the Fill-570 is installed in the terminal, the Formula Table report structure can also be configured.

**3.8.4.1. Format**

**Format**

Use the selection box for the Format field to select the width of all the Tare and Target table reports. The choices are:

- Narrow (40)** [default]      40 character-wide reports
- Wide (80)                      80 character-wide reports

**Header**

The Header field specifies the number of blank lines (CR/LF) to be placed at the start of each report. Values from 0 to 99 are accepted with **2** as the default.

**3.8.4.1.1. Title**

The Title selection box enables a default title line to be printed at the top of the report. Choices are:

- Disabled, **Enabled** [default]

**3.8.4.1.2. Record Separator**

A repeated character may be selected as a separator between printed records in the report. This step selects the character to be used. The character choices in the selection box are:

- None** [default], \* (asterisks), - (dashes), = (equals), CR/FL (blank line)

For example, if \* (asterisks) is selected, the resulting line separator will appear as follows:

\*\*\*\*\*

**3.8.4.1.3. Footer**

The Footer field specifies the number of blank lines (CR/LF) to be placed at the end of each report. Values from 1 to 99 are accepted with a default value of 5.



### 3.8.4.2. Tare Table

Use this setup screen to select which fields in the Tare Table will print when a Tare Table Report is printed. More details are provided in the **Reports** section of Appendix C, **Communications**. The ID field is always printed; it cannot be disabled.

#### 3.8.4.2.1. Tare

Selects if the tare value will be printed or not in the report. Choices are:

Disabled, **Enabled** [default]

#### 3.8.4.2.2. Description

Selects if the description will be printed or not in the report. Choices are:

**Disabled** [default], **Enabled**

#### 3.8.4.2.3. n

Selects if the totalization counter will be printed or not in the report. Choices are:

**Disabled** [default], **Enabled**

#### 3.8.4.2.4. Total

Selects if the total for each tare ID will be printed in the report. Choices are:

**Disabled** [default], **Enabled**

### 3.8.4.3. Target Table

Use this setup screen to select which fields in the Target Table will print when a Target Table Report is printed. More details are provided in the **Reports** section of Appendix C, **Communications**. The ID field is always printed; it cannot be disabled. Fields that display and can be enabled or disabled vary depending on how the Target Table is configured (refer to section 3.6.1.4 , **Application I Memory I Target Table**).

- If no Target mode is selected at **Application > Memory > Target Table**, the Target Table report setup cannot be accessed.

#### 3.8.4.3.1. Description

Selects if the description will be printed or not in the report. Choices are:

**Disabled** [default], **Enabled**

#### 3.8.4.3.2. Target

Selects if the target value will be printed or not in the report. Choices are:

Disabled, **Enabled** [default]

#### 3.8.4.3.3. +/- Tolerances

Selects if the tolerance values will be printed or not in the report. Choices are:

**Disabled** [default], **Enabled**

3.8.4.3.4. Spill  
 Selects if the spill value will be printed or not in the report. Choices are:

**Disabled** [default], Enabled

3.8.4.3.5. Fine Feed  
 Selects if the fine feed value will be printed or not in the report. Choices are:



**Disabled** [default], Enabled

### 3.8.5. Connections

The connections setup screen shows the physical port connections that have been programmed for the terminal. This includes the standard USB and COM1 serial port, the optional COM2 and COM3 serial ports, the COM4 serial port (POWERCELL versions only), the optional WiFi port, and the optional Ethernet port which supports multiple connections including the Eprint and Print Client ports. The optional ports are only available if the required option board has been installed. The USB port is a selectable output port which allows files to be written to an attached USB memory device.

The Connections screen lists what type of communication will occur over each programmed port. If no connections are programmed, no data transfer will be available on the COM ports, USB port or Ethernet ports.

#### 3.8.5.1. Editing and Creating Connection Assignments

1. Press the NEW softkey  to create a new connection assignment or press the UP and DOWN navigation keys to select (highlight) a connection assignment in the list to be edited and press the EDIT softkey  to open the setup screen for editing.
2. Parameters configured in the connections screen include the port and the type of input or output assignment. Depending upon these selections the remaining fields will vary but could include the trigger, the template to be sent, and if checksum will be sent or not.
3. Use the selection boxes for each field to select the port, associated assignment, and desired settings for the connection. Available selections are indicated in Table 3-11, organized by Port and Assignment. Specific details of the different assignments can be found in Appendix C, Communications.

**Table 3-11: Available Parameters, by Port and Assignment**



Port	Assignment	Trigger	Template	Checksum	# of Nodes
COM1 COM2 COM3 COM4	ASCII Input, CTPZ Input, Reports, SICS, Shared Data Server, Remote Display				
	Continuous Extended, Continuous Output			Disabled, Enabled	
	Continuous Template		Template 1-10		
	Demand Output, Totals Report	Scale, Trigger 1...3	Template 1-10		
	Remote Discrete I/O				0, 1, 2, 3
Ethernet 1	Continuous Extended, Continuous Output			Disabled, Enabled	
	Continuous Template		Template 1-10		

Port	Assignment	Trigger	Template	Checksum	# of Nodes
	Demand Output, Totals Report Reports	Scale, Trigger 1...3	Template 1-10		
Ethernet 2 Ethernet 3	Demand Output	Scale, Trigger 1...3	Template 1-10		
EPrint	Continuous Extended Continuous Output			Disabled, Enabled	
	Continuous Template		Template 1-10		
	CTPZ Input, Remote Display, Reports, SICS Demand Output, Totals Report	Scale, Trigger 1...3	Template 1-10		
Print Client	Continuous Extended, Continuous Output			Disabled, Enabled	
	Continuous Template		Template 1-10		
	Demand Output, Totals Report	Scale, Trigger 1...3	Template 1-10		
	CTPZ, Reports				
USB	ASCII Input, Reports				
	Demand Output, Totals Report	Scale, Trigger 1...3	Template 1-10		
WiFi	Demand Output	Scale, Trigger 1...3	Template 1-10		
	Remote Display, SICS				

### Connection options notes

	 <b>WARNING</b>
	<b>THE USB INTERFACE IS NOT CERTIFIED FOR USE IN DIVISION 2 OR ZONE 2/22 HAZARDOUS AREAS. USE ONLY IN SAFE AREA.</b>



- Not all choices are available for all connection assignments. Only valid choices are shown in the selection boxes.
- The Shared Data Server assignment is only available on COM1. Serial connection to the Shared Data Server is only possible on COM1. This assignment allows a user to connect to the Shared Data Server over COM1 without turning SW2-1 to the “on” position.
- The Trigger field displays only when the assignment selection is Demand Output. The Trigger 1, 2, and 3 selections for Trigger enable connection of a separate softkey, discrete input or a PLC command to trigger the output of the selected template. The discrete selection must be programmed separately (refer to section 3.6.3, **Discrete I/O**, for additional details on programming discrete inputs, and to the **IND570 PLC Interface Manual** for details on triggering commands via supported PLC protocols).
- The Template field displays only when the assignment selection is Demand Output, Continuous Template, or Totals Report. Only one template can be assigned to each connection.
- The default template for the Totals Report is Template 5.
- The Checksum field is available for continuous outputs only.

- The SICS selection provides Level 0 and Level 1 interface commands. Refer to Appendix C, **Communications** for details on the SICS protocol.
  - If usage conflicts occur, an alarm message displays.
  - EPrint offers a method to access the demand or continuous output data directly through the Ethernet port. Shared Data Server login and commands are not required to register for the data. The EPrint port is accessible only through the secondary port of the Ethernet interface, which can be configured in setup at **Communication > Network > Port**.
  - The # of Nodes refers to the number of ARM100 Remote I/O modules that will be connected in series to the IND570.
  - If the WiFi option is installed and is not assigned, access to the shared data server is enabled through the selected WiFi port number. If the WiFi option is assigned (either to Remote Display or SICS), the shared data server will not be available.
4. Press the OK softkey  to accept the connection parameters and return to the Connections setup screen when editing or adding the connection assignment is complete.
  5. Press the ESCAPE softkey  to discard the connection parameters and return to the Connections setup screen without saving the connection assignment edits or additions.
  6. Press the EXIT softkey  to return to the menu tree.

### 3.8.5.2. **Deleting a Connection:**

Use the UP and DOWN navigation keys to highlight a stored connection. Press the DELETE softkey  to delete a connection assignment from the Connections list.

### 3.8.5.3. **Clearing All Connections:**

To clear all connection assignments in the Connections list, press the CLEAR softkey  then press OK  to confirm the action.

## 3.8.6. **Serial**

Serial communication setup screens provide access to the communication parameters for the serial ports COM1, COM2, COM3 and COM4.

The COM2 and COM3 ports are only shown if the COM2/COM3 or COM2/COM3/DIO option board has been installed.

The COM4 port is only present in the POWERCELL versions.

- If "Remote Discrete I/O" is selected as the port assignment at **Communication > Connections**, the port parameters are automatically preset and cannot be changed.

### 3.8.6.1. **COM1, COM2, COM3, and COM4**

Use the COM1, COM2, COM3 and COM4 setup screens to configure the parameters for serial ports.

#### 3.8.6.1.1. **Baud**

Use the Baud selection box to set the baud rate for the serial port. Options are:

300, 600, 1200, 2400, 4800, **9600** [default], 19.2k, 38.4k, 57.6k, 115.2k

3.8.6.1.2. Data Bits

Use the Data Bits selection box to set the number of data bits. Choices are:

7, **8** [default]

3.8.6.1.3. Parity

Use the Parity selection box to set the parity. Choices include:

**None** [default], Odd, Even

3.8.6.1.4. Flow Control

Use the Flow Control selection box to set the handshaking mode. Selection are:

**None** [default], XON-XOFF (software handshaking)

- After an XOFF command is received on a serial port configured for XON/XOFF handshaking, all data remaining in the port's buffer will still be sent. All port buffers contain 64 bytes of data.

3.8.6.1.5. Interface

Use the Interface selection box to select the serial port interface. Selections include:

COM1	<b>RS-232</b> [default], RS-422, RS-485
COM2	<b>RS-232</b> (cannot be changed)
COM3	<b>RS-232</b> [default], RS-422, RS-485
COM4	<b>RS-232</b> (cannot be changed)

### 3.8.7. Network

The network branch appears only if either the Ethernet TCP/IP option or the WiFi option is installed. Programming selections in this branch will differ depending on which option is installed. Note that if both options are installed, the TCP/IP Ethernet option is supported and the WiFi module will be disabled.

Network setup screens include Ethernet, DNS Server, Proxy Server, Secondary Port, WiFi Module, WiFi Port, FTP, Print Client and Email Alert.

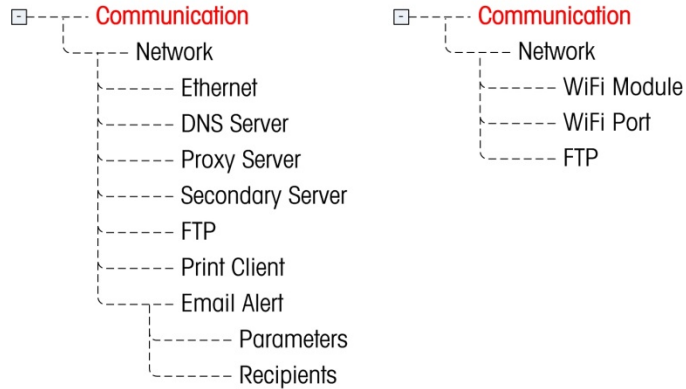

**Figure 3-20: Ethernet TCP/IP Menu Structure (left) and WiFi Menu Structure (right)**

**3.8.7.1. Ethernet**

Ethernet is available for TCP/IP transfer of data, shared data server access, connection via the EPrint port, email alerts, FTP, and saving and restoring configurations with InSite SL.

**3.8.7.1.1. MAC Address**

The Medium Access Control (MAC) Address cannot be edited; it is shown for information only.

**3.8.7.1.2. DHCP Client**

If DHCP (Dynamic Host Configuration Protocol) Client is enabled, the IP Address, Subnet Mask, and Gateway Address fields are assigned automatically by the network. They become read-only in the setup screens. If **Disabled**, the IP address must manually be assigned in the following fields. Choices are:

**Disabled** [default], Enabled

**3.8.7.1.3. IP Address**

Enter the IP address (or view if DHCP Client is enabled) for the IND570 terminal. After each group of digits has been entered, press ENTER to proceed to the next group. The default value for the IP is 192.68.0.1.

**3.8.7.1.4. Subnet Mask**

Enter the subnet mask (or view if DHCP Client is enabled) for the IND570 terminal. After each group of digits has been entered, press ENTER to proceed to the next group. The default value for the subnet mask is 255.255.255.0.

**3.8.7.1.5. Gateway Address**

Enter the gateway address (or view if DHCP Client is enabled) for the IND570 terminal. After each group of digits has been entered, press ENTER to proceed to the next group. The default value for the gateway is blank.

After entries are complete, press the EXIT softkey to return to the menu tree

### 3.8.7.2. DNS Server

Domain Name Servers (DNS) are the internet's equivalent of a phone book. They maintain a directory of domain names and translate them to Internet Protocol (IP) addresses. This is necessary because, although domain names are easy for people to remember, machines use IP addresses to access the internet.

#### 3.8.7.2.1. Automatic DNS Address

Allows the network within which an IND570 is connected to automatically assign a DNS server for use by the terminal. Choices are:

**Enabled** [default], Disabled

If enabled is selected, the remaining fields display the address but cannot be edited. When disabled, the DNS server addresses can be manually programmed.

#### 3.8.7.2.2. Preferred DNS server, Alternate DNS server

Enter the DNS Server address (or view if Automatic DNS Addressing is enabled) for the IND570 terminal. After each group of digits has been entered, press ENTER to proceed to the next group.

### 3.8.7.3. WiFi Module

The WiFi Module setup pages are shown below.

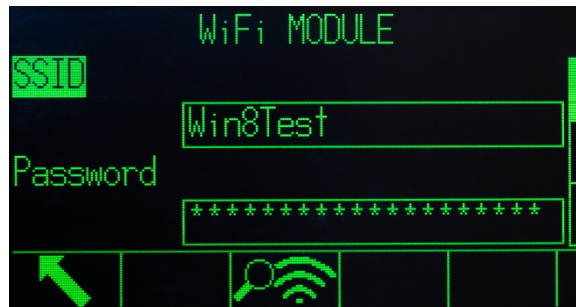



Figure 3-21: WiFi Module Setup, Page 1 of 3

- If Russian or Chinese characters are entered in the SSID field, they will not be displayed accurately because this field uses UTF8 code set.

Soffkey 3  triggers a scan for wireless access points (WAPs).

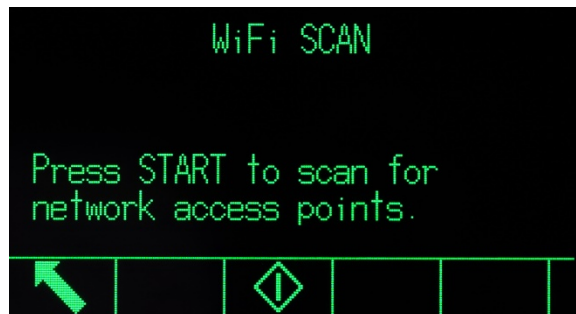

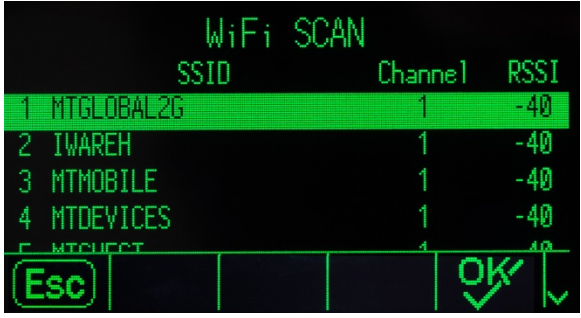



Figure 3-22: WiFi Scan Screen

Press START  to begin the scanning process. A confirmation screen will display "Scanning..." for a few seconds.

When the scan is complete, the 10 access points with the strongest signal strengths are listed, strongest first, together with the channel each uses and its signal strength (RSSI).



**Figure 3-23: WiFi Scan Results**

Use the UP and DOWN navigation keys to move focus to any of the WAPs shown. Press ESCAPE  to exit the screen without selecting an SSID and return to the **WiFi Module** screen. Press OK  to enter the selected WAP into the SSID field and return to the **WiFi Module** screen.

Press the DOWN arrow to move to the second WiFi Module screen.



**Figure 3-24: WiFi Module Setup, Page 2 of 3**

The DHCP Client can be Enabled or Disabled.

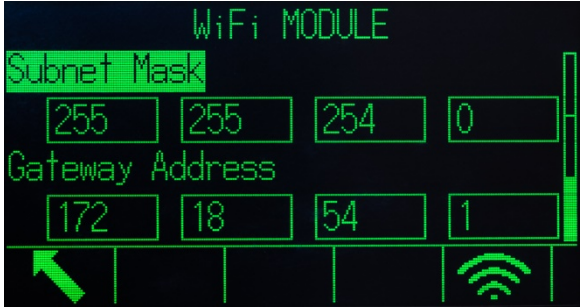

**Figure 3-25: WiFi Module Setup, Page 3 of 3**

Softkey 5  causes the terminal to attempt to connect using the selected parameters (WAP, IP Address, etc.). A **Connection Status** screen shows the attempt in progress. In this case, the IND570 is attempting to connect to the WAP with an SSID of "WinTest."





**Figure 3-26: WiFi Module Connecting**

If the connection attempt succeeds, a confirmation screen appears. If the attempt fails, the screen will display "Connection failed" and provide an explanation for the failure.

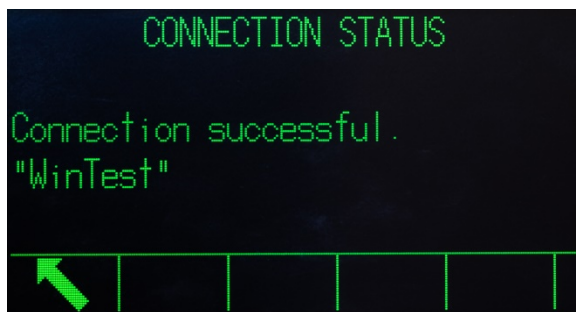

**Figure 3-27: WiFi Module Connection Succeeded**

#### 3.8.7.4. WiFi Port

The WiFi Port setup screen includes only one parameter – the WiFi Port number.



**Figure 3-28: WiFi Port Setup Screen**

#### 3.8.7.5. Proxy Server

A proxy server is a computer that acts as a gateway between a local network and a larger-scale network such as the Internet. Proxies allow users to make indirect network connections to other computer network services. For example, SMTP proxy servers are often used to control email traffic in and out of a user's local network.

The IND570 supports two types of proxy servers – HTTP and SOCKS. A SOCKS server is a general purpose proxy server that establishes a TCP connection to another server on behalf of a client, then routes all the traffic back and forth between the client and the server. A SOCKS server never interprets the network traffic between client and server in any way, and is often used because clients

are behind a firewall and are not permitted to establish TCP connections to servers outside the firewall unless they do it through the SOCKS server.

An HTTP proxy is similar, and may be used for the same purpose when clients are behind a firewall and are prevented from making outgoing TCP connections to servers outside the firewall. However, unlike the SOCKS server, an HTTP proxy does understand and interpret the network traffic that passes between the client and downstream server.

#### 3.8.7.5.1. Proxy Server

Consult with a facility's IT department when enabling the Proxy server. The IT department should know which selection is appropriate. The proxy server is used only to support the InTouch feature, and **not** for email. IND570 Proxy Server settings include:

**Disabled** [default], HTTP, SOCKS

If disabled, no further fields are displayed. If HTTP or SOCKS is selected, two additional pieces of information are necessary to configure the proxy server connection – the IP address of the proxy server and the port number.

#### 3.8.7.5.2. Server Address

The Server Address field allows the entry of the URL or IP address of the proxy server.

#### 3.8.7.5.3. Port

The Port field allows the entry proxy server port number.

#### 3.8.7.5.4. Username and Password

If the proxy server in use requires a security login to grant access, enter the username and password of the IND570 device here. This username/password should be supplied by the customer's local IT department.

### 3.8.7.6. Port

The Port setup screen displays the primary Ethernet port number and also allows a secondary port number to be configured for the same physical Ethernet interface. The primary port is reserved for the Shared Data Server access, which is described in Appendix C, **Communications**. The secondary port allows for either Shared Data Server access or EPrint connections, if configured. The primary and secondary ports can be used concurrently.

#### 3.8.7.6.1. Primary Port #

The Primary Port number for the Ethernet TCP/IP interface is fixed at 1701, and is displayed as a read-only field in the Port setup screen. The Primary Port number can be modified through a Shared Data write.

#### 3.8.7.6.2. Secondary Port

If a valid, user-defined Secondary Port number is entered, the Shared Data Server will also be accessible on a second TCP/IP port. However, if an EPrint connection is configured in setup at **Communication > Connections**, Shared Data Server access is no longer be available on this port. This secondary port will be used only for EPrint connections.

- A change to the Secondary Port number may require a manual power cycle of the terminal before the change becomes active.

### 3.8.7.7. FTP



- Access to the FTP function must be enabled. Refer to section 3.8.1.1, **Ethernet**, for details.

The setup screen for FTP displays usernames and access levels for file transfers. Access levels for all files are shown in Appendix C, **Communications**, in the FTP section. Usernames can be edited, inserted, or deleted.

There are two default usernames of "admin" and "anonymous". The "admin" username has administrator rights and a password of "admin". The "anonymous" username has operator rights and no password. The "admin" username cannot be deleted and the access level cannot be changed but the password can be modified if required.

- Some FTP programs (for example FileZilla), cannot be used with the WiFi option for file transfer because they make two simultaneous connections and the IND570 WiFi module supports only one connection.

#### 3.8.7.7.1. To Edit or Create a Username

1. Press the NEW softkey  to open the setup screen to create a new user or press the UP and DOWN navigation keys to select (highlight) a username in the table to be edited. Press the EDIT softkey  to open the setup screen for editing a user.

2. Press the ENTER key to select the Username field.

- The Username field is accessible only when entering a new FTP user.

3. Use the alphanumeric keys to edit or enter the desired username then press ENTER.

4. Use the Access selection box to assign the appropriate access level to the user. The following access levels are available:

**Operator** [default], Supervisor, Maintenance, Administrator

5. Enter the desired password in the Password and Confirm Password fields.



6. Press the OK softkey  to accept the username and password as entered.

7. Press the ESCAPE softkey  to exit without saving the username and password.

#### 3.8.7.7.2. To Delete a Username

Press the DELETE softkey  to delete a username from the table on the Users screen.

#### 3.8.7.7.3. To Clear All Usernames

To clear all usernames from the list and leave only the default username "admin", press the CLEAR softkey  then OK  to confirm the action.

### 3.8.7.8. Print Client

The Print Client connection allows the IND570 to send data directly to a specific IP address on the same network as the IND570.

- Port 1701 is not available for assignment, as it is reserved for use as the shared data port. An on-screen prompt will indicate that 1701 is an invalid value for the Print Client.

#### 3.8.7.8.1. Server IP Address

Enter the Server IP Address. The Server IP Address is the IP address of the device where the IND570 is sending the print information. The default IP address is **0.0.0.0**.

#### 3.8.7.8.2. Server TCP Port

Enter the server TCP port number for the device the data is to be sent to. The default port is **8000**.

### 3.8.7.9. Email Alert

When the Ethernet communication option is installed, IND570 can be configured to send email alerts when certain system events occur in the weighing system.

- The Ethernet connection used to send email alerts is separate from those configured at **Communication > Connections**.

The Email Alert branch is used to configure the following email parameters. Much of the information required to configure Email Alerts will be determined by consulting with the customer's local IT department.

#### 3.8.7.9.1. Parameters

##### SMTP Server IP

This value is set using four groups of numbers, representing the IP address of the mail server the IND570 will use to send alerts. Default is **0.0.0.0**.

##### Sender Email Address

This alphanumeric entry field stores the email address of the IND570. Default is **[blank]**.

##### Username

This alphanumeric entry field is used to store a unique name for the IND570 that will appear in the "From" field of alert emails. Default is **IND570**. This is also the username used to login to a server (if required). This field cannot contain spaces or blanks in the name. If spaces/blanks are used, the email transmission will fail.



##### Password, Confirm Password



This alphanumeric entry field is used to define a password that will allow the IND570 to access the SMTP server used for email communication.

#### 3.8.7.9.2. Recipients



Up to 6 Recipients can be defined as the recipients of different categories of email alerts.

##### To Add or Modify Email Recipients

1. Press the NEW softkey  to create a new record.
2. To edit an existing record, press the UP and DOWN navigation keys to select (highlight) a record in the list then press the EDIT softkey  to open the edit screen.

3. Press the UP and DOWN navigation keys to move the focus to the field name to be edited or inserted.
4. Press the ENTER key to select a field value to edit or insert.
5. Use the alphanumeric keypad to edit or enter the desired value.
6. Press the OK softkey  to accept the modifications or additions.
7. Press the ESCAPE softkey  to return to the Email Recipients screen without saving modifications or additions.
8. Press the EXIT softkey  to return to the Recipients screen.

#### To Delete or Clear Email Recipients

1. Press the UP and DOWN navigation keys to move the focus to the record to be deleted. Press the DELETE softkey  to delete this record from the list.
2. Press the EXIT softkey  to return to the Recipients screen.

An email test is available for testing the validity of an email address as well as the connection to the SMTP server. After an Email Recipient is defined, press the TEST  softkey to send an email alert message, titled "Email Alert Test Message," to the recipient that is highlighted in the list.

#### 3.8.7.9.3. Email Address

This alphanumeric entry field is used to enter the recipient's email address. Default is **[blank]**. Up to 6 recipients can be configured.

#### 3.8.7.9.4. Alerts

IND570 supports four different categories of email alerts: Information, Warning, Failure and Service. Each category of alerts can be **disabled** [default] or enabled for each recipient. All IND570 automatic email alerts are listed in the table in Chapter 2, the **Automatic Email Alerts** section.

In addition to receiving the Service Alerts listed in Chapter 5, Recipients with Service Alerts "enabled" will also receive any service emails manually triggered from the Service Information Recall screens (Figure 3-29).



Figure 3-29: Service Information Recall View

### 3.8.8. PLC

The PLC parameters are only available when a PLC option is installed. The setup parameters shown will depend upon which PLC option is installed. All PLC types except Analog Output will also include a Data Format branch. When the Ethernet/IP-Modbus TCP, PROFIBUS, PROFINET or

ControlNet interface is installed, an additional setting, **Operating Mode**, appears in the Data Format branch.

### 3.8.8.1. Analog Output

The IND570 terminal's analog output option provides either 4-20 mA or 0-10 volt DC outputs depending on how the connection is wired. The output can be configured to represent different source values.

#### 3.8.8.1.1. Source

This parameter determines what data will be used as the source of the analog output. Selections include:

<b>None</b> [default]	Analog output signal disabled
Application	Analog output signal controlled by a TaskExpert program
ABS – Displayed Weight	Analog output signal triggered on the absolute value of the displayed weight
ABS – Rate *	Analog output signal triggered on the absolute value of the rate
Displayed Weight	Analog output signal triggered on the displayed weight
Gross Weight	Analog output signal triggered on the gross weight
Rate *	Analog output signal triggered on the rate when Rate is enabled*

#### 3.8.8.1.2. Output Type

Choose the operating mode and range for the analog output signal. Selections include:

0 – 10V, **4 – 20mA** [default]

#### 3.8.8.1.3. Zero Value



The beginning zero value for the analog output can be adjusted. This value can be for weight or rate, depending on the selected source. In the Zero Value field, enter the value at which the "zero" output of the analog signal should occur.

#### 3.8.8.1.4. Full Scale Value

The beginning full scale span value for the analog output can be adjusted. This value can be for weight or rate, depending on the selected source. In the Full Scale Value field, enter the value at which the "full scale span" output of the analog signal should occur.

#### Fine Adjustment of Zero and Span

If these preprogrammed values do not provide the exact outputs required, they may be trimmed by using the ZERO →|← and SPAN →|← soffkeys located at the bottom of the screen as follows:

1. Press the ZERO soffkey →|← to initiate the zero fine-tuning process or the SPAN soffkey →|← to initiate the span fine-tuning process. In either case, a warning screen offers two options – OK  to continue with the operation, or EXIT  to return to the Analog Output screen without making any adjustment.

2. The analog output signal value will change during this procedure – ensure that the PLC or other control equipment is disconnected. A warning message displays asking for verification to continue.
3. Once the OK softkey  has been pressed, the zero fine-tuning or span fine-tuning operation begins. A message screen appears, showing the current value of the analog output signal. Use the softkeys that display to adjust the signal if necessary as follows:

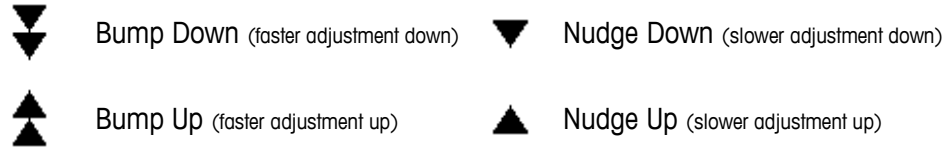

4. Press the EXIT softkey  to return to the previous screen.

### 3.8.8.2. ControlNet

The ControlNet PLC interface enables the IND570 terminal to communicate to ControlNet Programmable Logic Controllers (PLCs) through direct connection to the ControlNet network.

Additional interface information and programming examples can be found in the **IND570 PLC Interface Manual**, available for download at [www.mt.com/IND570](http://www.mt.com/IND570).

#### Node Address

Each terminal connected to the network represents 1 physical node. This address is determined by the system designer, and then configured in the IND570 Terminal by selecting the Node Address text box and using the numeric keypad to enter the appropriate node address (0–125). The default address is **99**.

### 3.8.8.3. DeviceNet

The DeviceNet Interface can be configured to run up to 500Kbits per second depending on cabling and distances. Messages are limited to 8 un-fragmented bytes. The network can include up to 64 nodes including the master, commonly called the scanner.

Additional interface information and programming examples can be found in the **IND570 Terminal PLC Interface Manual** available for download at [www.mt.com/IND570](http://www.mt.com/IND570).

#### Node Address

Each IND570 Terminal connected to the network represents one physical node. This address is determined by the system designer, and then configured in the IND570 Terminal by selecting the Node Address text box and using the numeric keypad to enter the appropriate node address (0–63). The default address is **63**.

#### 3.8.8.3.1. Data Rate

Use the selection box to select the desired data rate. Selections available are:

**125 Kb** [default], 250 Kb, 500 Kb

### 3.8.8.4. EtherNet/IP and Modbus TCP

These parameters are used to program the operation of the EtherNet/IP and Modbus TCP option board. The same option board can support both protocols.

Additional interface information and programming examples can be found in the **IND570 PLC Interface Manual**, available for download at [www.mt.com/IND570](http://www.mt.com/IND570).

#### 3.8.8.4.1. MAC Address

The Medium Access Control (MAC) Address cannot be edited; it is shown for information only.

#### 3.8.8.4.2. DHCP Client

If DHCP (Dynamic Host Configuration Protocol) Client is enabled, the IP Address, Subnet Mask, and Gateway Address fields are assigned automatically by the network. They become read-only in the setup screens. If disabled, the IP address must manually be assigned in the following fields. Choices are:

**Disabled** [default], Enabled

#### 3.8.8.4.3. IP Address

Enter the IP address (or view if DHCP Client is enabled) for the IND570 terminal. After each group of digits has been entered, press ENTER to proceed to the next group. The default value for the IP is **192.68.0.1**.

#### 3.8.8.4.4. Subnet Mask

Enter the subnet mask (or view if DHCP Client is enabled) for the IND570 terminal. After each group of digits has been entered, press ENTER to proceed to the next group. The default value for the subnet mask is **255.255.255.0**.

#### 3.8.8.4.5. Gateway Address

Enter the gateway address (or view if DHCP Client is enabled) for the IND570 terminal. After each group of digits has been entered, press ENTER to proceed to the next group. The default value for the gateway is blank.

### 3.8.8.5. PROFIBUS

The PROFIBUS DP Interface supports discrete data transfer that enables bi-directional communication of discrete bit-encoded information or 16-bit binary word (signed integer) numerical values.

Additional interface information and programming examples can be found in the **IND570 Terminal PLC Interface Manual**, available for download at [www.mt.com/IND570](http://www.mt.com/IND570).

#### 3.8.8.5.1. Node Address

Each IND570 Terminal connected to the network represents one physical node. This address is determined by the system designer, then configured in the IND570 Terminal by selecting the Node Address text box and using the numeric keypad to enter the appropriate node address (0–125). The default value is **1**.



3.8.8.5.2.

Shared Data

The Shared Data parameter enables or disables an extended message length that includes shared data access. This data is added to the end of the standard scale slot information and extends the message length. Choices are:

**Disabled** [default], Enabled

**3.8.8.6.**

**PROFINET**

These parameters are used to program the operation of the PROFINET option board. Additional interface information and programming examples can be found in the **IND570 PLC Interface Manual**, available for download at [www.mt.com/IND570](http://www.mt.com/IND570).

3.8.8.6.1.

MAC Address

The Medium Access Control (MAC) Address cannot be edited; it is shown for information only.

3.8.8.6.2.

IP Assignment

Program for DCP (Discovery and Configuration Protocol) or DHCP (Dynamic Host Configuration Protocol) if the IP Address, Subnet Mask, and Gateway Address fields are assigned automatically by the network. They become read-only in the setup screens. If set to manual, the IP address must manually be assigned in the following fields. This selection must match the operation of the PROFINET PLC. Choices are:

**DCP**[default], DHCP, Manual

3.8.8.6.3.

IP Address

Enter the IP address (or view if DCP or DHCP is selected) for the IND570 terminal. After each group of digits has been entered, press ENTER to proceed to the next group. The default value for the IP is **192.68.0.1**.

3.8.8.6.4.

Subnet Mask

Enter the subnet mask (or view if DCP or DHCP is selected) for the IND570 terminal. After each group of digits has been entered, press ENTER to proceed to the next group. The default value for the subnet mask is **255.255.255.0**.

3.8.8.6.5.

Gateway Address

Enter the gateway address (or view if DCP or DHCP is selected) for the IND570 terminal. After each group of digits has been entered, press ENTER to proceed to the next group. The default value for the gateway is blank.

3.8.8.6.6.

Device Name

This view-only step shows the device name as assigned by the PLC.

### 3.8.8.7. Data Format

Use the Data Format setup screen to configure the PLC data format.

#### 3.8.8.7.1. Operating Mode

The Operating Mode setting is only available when a ControlNet, Ethernet/IP-Modbus TCP, PROFIBUS or PROFINET interface is installed. For the PROFINET interface, this value is set to Compatibility Mode and cannot be changed. Choices are:

**Compatibility Mode** [default], IND560 Emulation

Depending on the Byte Order selection (refer to section 3.8.8.7.3, Byte Order, below), **Compatibility Mode** will provide the same discrete mode byte order arrangements as the METTLER TOLEDO IND131/331 and IND780 terminals. If **IND560 Emulation** is selected, the transmitted bytes in discrete mode will match the existing IND560 byte order determined by the Byte Order selection. Byte order arrangement in the IND560 terminals does not match that of IND131/331 and IND780. IND560 Emulation mode should be chosen **only** when replacing an IND560 **and** the programming within the PLC will not be modified.

#### 3.8.8.7.2. Format

Select the desired PLC format from the Format field selection box. Selections include:

- Divisions                      PLC format that provides scale increment data transfer.
- Floating Point** [default]    PLC format that provides 32-bit floating point data transfer in 16-bit integer format.
- Integer                         PLC format that provides 16-bit integer data transfer

#### 3.8.8.7.3. Byte Order

The step determines the order of the data as presented in the 4 or 8 bytes of data. Select the desired byte order field selection box. Selections are:

- Byte Swap                      Makes the data format compatible with S7 PROFIBUS
- Double Word Swap            Makes the data format compatible with the Modicon Quantum PLC for Modbus TCP networks
- Standard                        Makes the data format compatible with PLC 5
- Word Swap** [default]        This format is compatible with RSLogix 5000 processors

Table 3-12 provides an overview of the various data format modifications.

**Table 3-12: Data Format Modifications**

		Word Swap			Byte Swap			Double Word Swap			Standard / Historic		
Terminal Weight Value		1355											
PLC		15	Bit #	0	15	Bit #	0	15	Bit #	0	15	Bit #	0
<b>Integer / Division</b>	Weight value word	0x054B Hex			0x4B05 Hex			0x4B05 Hex			0x054B Hex		
<b>Floating</b>	1 <sup>st</sup> Weight value word	0x6000 Hex			0xA944 Hex			0x0060 Hex			0x44A9 Hex		

		Word Swap			Byte Swap			Double Word Swap			Standard / Historic		
<b>Terminal Weight Value</b>		1355											
<b>PLC</b>		15	Bit #	0	15	Bit #	0	15	Bit #	0	15	Bit #	0
<b>Point</b>	2 <sup>nd</sup> Weight value word	0x44A9 Hex			0x0060 Hex			0xA944 Hex			0x6000 Hex		

#### 3.8.8.7.4. Message Slots

This parameter refers to the number of slots of data that will be transferred. Typically only one slot is used in a single scale application, but sometimes an application requires multiple fields of data in a cyclic data transfer. In order to accomplish this, two, three, or even four message slots can be assigned for the output. As the number of message slots is increased, so is the length of the message, because each slot requires enough memory to transmit a complete set of data. More detailed information can be found in the IND570 Terminal **PLC Interface Manual**, available for download at [www.mt.com/IND570](http://www.mt.com/IND570).

Choose the number of message slots from the selection box. The choices are:

1 [default], 2, 3, 4

### 3.8.9. Reset

The Reset setup screen restores Communication branch setup values to their factory default settings.

To initiate a reset, press the OK softkey . If the reset was successful, a verification message that reads "Reset Successful" displays. If the reset was not successful, an error message that reads "Reset Failure" displays. If the reset fails, try to initiate the reset again. If the reset continues to fail, contact a local METTLER TOLEDO representative for assistance.

Press the ESCAPE softkey  to exit without resetting.

## 3.9. Maintenance

The maintenance setup branch includes the views and settings described in this section.

### 3.9.1. Configure/View

The Configure/View setup branch provides access to parameters for Change Log, Maintenance Log, Error Log, Calibration Management, Test Manager GWP®, Calibration Test, all GWP® Tests, InTouch<sup>SM</sup> Remote Service and several features unique to POWERCELL terminals.

#### 3.9.1.1. Change Log



The change log file tracks changes to terminal configuration and shared data. The Change Log is approximately 150k bytes in size. Each record could vary in length, but the Change Log will store an average of 2,500 records.

- Once the Change Log is full, it must be cleared or reset before additional entries (changes to settings and shared data) can be made.

More details regarding the structure of the Change Log can be found in Appendix B, **Table and Log File Structure**.



The Change Log can be **Disabled** [default] or **Enabled**.

#### 3.9.1.1.1. To View Change Log Records

1. Press the VIEW TABLE softkey . The Change Log Search screen displays.
2. Use the Search Field 1 and Search Field 2 selection boxes and associated data fields to enter specific search information to limit the search by date, shared data (SDName), time, username, or leave the default \* (the "find all" character) to view all Change Log information.
3. Press the START SEARCH softkey . The Log Search View screen displays with the search results sorted in chronological order (The most recent change record displays at the end of the file with focus. Older records may be viewed by pressing the UP navigation key.).



Information displayed in the Change Log View includes:

Date, Time, User Name, Shared Data Field Name, New Value

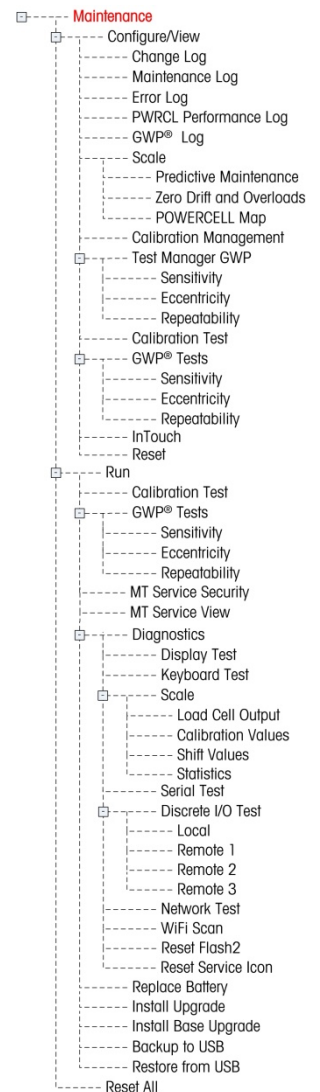
4. Press the PRINT softkey  to print the list to all Report connections.
5. Press the EXIT softkey  to return to the Change Log Search Screen.



#### 3.9.1.1.2. To Reset All Records in the Change Log File

1. Press the RESET softkey . A warning message displays asking for verification that all configuration change records are to be reset.
2. Press the OK softkey . The configuration change records history is reset. Press the ESCAPE softkey **Esc** to return to the Change Log screen without executing a reset.
3. If the reset was successful, a verification message that reads "Reset Successful" displays. Press ENTER to acknowledge the reset and return to the Change Log screen.
  - If the reset fails, an error message that reads "Reset Failure" displays. If the reset fails, try to initiate the reset again. If the reset continues to fail, contact a local METTLER TOLEDO service representative for assistance.

#### 3.9.1.2. Maintenance Log

The Maintenance Log is a record of routine maintenance or activities such as capture span and capture zero. Use the selection box on this setup screen to select Disabled or **Enabled** [default] for the maintenance log.



The Maintenance Log is approximately 150k bytes in size. Records may vary in size, but the Maintenance Log will store an average of 2,500 records. More details regarding the Maintenance Log can be found in Appendix B, **Table and Log File Structure** and Chapter 5, **Service and Maintenance**.

Reset all records, view records or print records in the Maintenance Log by following the same steps described for Change Log.

Information that displays on the Maintenance Log Search View screen includes:

Date, Time, Username, Event, Status

#### 3.9.1.2.1. New Maintenance Log Entry

The NEW softkey  on the Maintenance Log screen opens an ADD MAINTENANCE RECORD screen, intended to record the upgrade or repair of equipment. From this screen, an Event may be added, removed or replaced, and its status recorded in an 8-character alphanumeric entry field. Press OK  to confirm the change, or ESC **Esc** to exit the screen without changing the Maintenance Log.

#### 3.9.1.3. PWRCL Performance Log (POWERCELL version only)

The POWERCELL (PWRCL) Performance Log provides a summary of the performance and diagnostics data collected on a scale using POWERCELL load cells. The log will hold approximately 500 individual records before it begins over-writing the oldest entries. Note that the accumulation of data in the log depends on the number of cells in the system – each cell produces one record at each log interval.

More details regarding the PWRCL Performance Log can be found in Appendix B, **Table and Log File Structure**.

#### 3.9.1.3.1. Log Interval

Use the Log Interval entry box to enter a time interval in hours for the terminal to automatically record a set of data in the log. Valid entries are from **0** to **999.9**. A value of **0** (default) disables the

automatic logging. For day-to-day operation, 7 days or **168** hours (default value) is a typical value. When a scale is being tested, the interval can be reduced to collect data more frequently.

The user can also trigger a record manually by pressing the PWRCL LOG softkey  from this setup screen. A manual record can also be created using the same softkey when it is assigned to the home screen.

Pressing the PWRCL LOG softkey  does not make the log visible on screen. It simply creates a record in the log. There is no visual indication that this has taken place.

The PWRCL Performance Log cannot be viewed in the terminal. To see the log file, retrieve the **gen:\pdx\_per.csv** file via FTP or serial file transfer, or the USB softkey, or use the InSite CSL software tool.

The MT Service Security feature must be unlocked in order to retrieve the records in the log. Refer to the MT Service Security section.

To clear the records from the PWRCEL Performance Log, press the CLEAR softkey **C**. Once pressed, a warning message displays asking for verification that all records are to be cleared. Press the OK softkey  to continue, or press the ESCAPE softkey **[Esc]** to return to the PDX Performance Log screen.

#### 3.9.1.4. Error Log

The Error Log is a record of significant errors that occur in the weighing system. Use the selection box on this setup screen to select Disabled or **Enabled** [default] for the Error Log.

Each record can vary in size, but the Error Log will store an average of 500 records. The Error Log is described in more detail in Appendix B, **Table and Log File Structure**, and in Chapter 5, **Service and Maintenance**.

Reset all records, view records or print records in the Error Log by following the same steps described for Change Log.

Information that displays on the Error Log Search View screen includes:

Date, Time, Severity, Error Code, Detail (count) and Error Message

#### 3.9.1.5. GWP<sup>®</sup> Log

The GWP Log records the final basic results of sensitivity, reproducibility and eccentricity tests that are performed in the terminal. Use the selection box on this setup screen to select **Disabled** [default] or Enabled for the GWP Log.

The GWP Log will store approximately 2,500 records. Additional details on the GWP Log can be found in Appendix B, **Table and Log File Structure**.

Reset all records, view records or print records in the GWP Log by following the same steps described for Change Log.

### 3.9.1.6. Scale (POWERCELL version only)

#### 3.9.1.6.1. Predictive Maintenance

##### Symmetry Monitor

Set the symmetry monitor to **None** (the default) or Radial.

- **Radial** symmetry should be used on any system where all the cells see almost identical loads (such as a cylindrical tank or hopper scale).

##### Start Threshold

To prevent a false trigger of a symmetry error due to light loads, the terminal allows for a symmetry check start threshold value. This value is entered as a percentage of the calibrated scale capacity. The default value is **0%**. Symmetry checking will be triggered only if the load on the scale exceeds the start threshold value.

##### Difference Threshold

Enter the maximum permissible percent deviation in span between symmetrical cells. The default value is **0%**.

Execution of radial symmetry checking is based upon a comparison between the **current** distribution of values between load cells and the distribution **at calibration**. A symmetry error is triggered if the change in load distribution exceeds the Difference Threshold value.

##### Timer Interval

The Timer Interval is used to supplement the terminal's normal Stability settings, which determine when the scale is in a no-motion state. The interval can be set to any value from **0.0** (default) to 120.0 seconds. Note that if the stability settings and timer interval are set too high, Symmetry Monitoring will effectively be **turned off**, without any notice from the terminal.

##### On Failure

Set the alarm level when a possible failure is detected. The options are:

- **Alarm & Disable** (default)
- Alarm Only

The Maintenance Log must be enabled for Alarms to be recorded. For Alarm Only conditions, the alarm message will remain on the display until the values fall to 90% of the parameters specified in setup. If the scale has been disabled, Symmetry Monitoring must be turned off or changed to Alarm Only (and the values fall to 90% of the parameters specified in Set Up), and the home screen displayed before the error will clear.

##### Run Flat

If the terminal determines that a load cell is operating out of tolerance or fails to detect communication with a single load cell, it can invoke the Run Flat algorithm to compensate for the cell's questionable readings until the cell can be replaced.

Load cell symmetry monitoring is required for the algorithm to run properly. There are 3 options for Run Flat:

- **Disabled** (default) - Run Flat will not operate
- Automatic - Run Flat algorithm uses threshold settings to determine which cell to replace
- Manual - user selects which cell to replace

If **manual** is selected, a field titled Manual Cell # will appear. Enter the number of the cell you would like to replace with the Run Flat estimate.

Once Run Flat is triggered, a message will remain on the display until Run Flat is disabled or the conditions fall to 90% of the parameters in Set Up.

To disable Run Flat and return to normal operation once the error condition has been corrected, do one of the following:

- Cycle power to the IND570.
- Enter setup and access **Maintenance > Configure > Predictive Maintenance**, and disable Run Flat.

#### 3.9.1.6.2. Zero Drift and Overloads

For POWERCELL bases, the Zero Drift and Overloads screen is accessible. These settings permit early diagnosis of load cells that are failing, and help prevent possible damage to weighing equipment caused by excessive loads. A Zero Drift error will not be triggered if the scale is in motion.

##### Zero Drift Check

The Zero Drift check option may be **Disabled** (default), set to **Alarm only** or to **Alarm and Disable**. If an error is triggered, and the Maintenance Log is enabled, the error will be recorded in the Maintenance Log.

When a scale Zero command is issued the scale is assumed to be empty. The IND570 will first test to see if the Total Zero Drift / Scale Capacity > 1%. If it is, it then tests the percentage of total Zero Drift any one load cell contributes. If it is over the user defined Threshold, either an error is raised and the alarm is logged or an error is raised, the alarm is logged and the scale is disabled.

To clear an Alarm Only error, the values of either test 1 or test 2 must fall to below 90% of the specified parameter. To clear an Alarm and Disable Scale error, Zero Drift Monitoring must be turned off or changed to Alarm only and the terminal must be back in the Run Screen.

Note that a Zero Drift Error will not be raised if the zero value is outside the Zero Range. Instead, a Zero Range error will be displayed

- The Zero Drift Check functions will not be supported if CalFree is used during scale calibration.

##### Zero Threshold

The Zero Threshold value is set as a percentage of the calibrated load cell capacity. The Threshold can be set at 50-100%. The default value is **50%**. If the Maintenance Log is enabled, an alarm message will be displayed for 10 seconds in the System Line, and will reappear periodically after a fixed period of time if the error is not resolved.



Note that an out-of-tolerance zero value for a load cell does not mean that the scale zero range (configured in setup at **Scale > Zero > Ranges**) has been exceeded. In that aggregate measure, individual variations between load cells may cancel one another out. An error generated by a load cell will not necessarily prevent the scale as a whole from zeroing. If the scale is out of its zero range, an error message will appear prompting the operator to correct the fault condition.

### Overload Threshold

The threshold at which a cell overload is logged may be set as a total weight value in primary weight units. The value entered should also account for the pre-load amount and typically not exceed the load cell's rated capacity. The overload trigger is not re-set until the measured weight falls below 90% of the overload threshold value.

#### 3.9.1.6.3. POWERCELL MAP

This branch provides a graphical view of connected load cells. When completed, the network diagram will help to clarify errors reported by showing the physical load cell layout (by address), identifying the cell to which the home run cable connects, and which load cell is the last in the network. It is recommended that the load cell network be sketched on a sheet of paper before completing the functions described in this section.

Figure 3-30 shows a POWERCELL map. Before mapping is performed, each cell's address appear as a "?," and the cable connection list below the diagram is blank. The platform graphic includes the number of loads cells specified in setup at **Scale > Type > # of Load Cells**. Use the navigation keys to move focus from one cell position to the next in the diagram.



**Figure 3-30: POWERCELL Map View**

Note that the position of each cell in a platform is designated alphabetically – to differentiate it from the numeric address value. Figure 3-31 shows the alphabetic positions for 14 load cells. In the example shown in Figure 3-30, only the first position is used.

A	C	E	G	I	K	M
B	D	F	H	J	L	N

**Figure 3-31: Alphabetic Designation of Load Cells in a Platform**

These alphabetical designations will appear, with the corresponding node number, in the **Position** column of the **POWERCELL Map Table View** screen (Figure 3-36).

### Editing

Pressing the **EDIT**  softkey on the **POWERCELL Map** screen displays the **Node Edit** screen, which allows entry of the information required to create a graphic representation of the load cell network.



**Figure 3-32: Node Edit Screens**

The **Node Edit** screen includes the following parameters and softkeys:

- This Node #**      The cell address of the current cell position. Default value is null; the drop-down box lists all available cells. Select the cell address of the physical location in focus in in the network graphic, then press ENTER.
- HR Cable**        Select **No** if the Home Run cable is not connected to this cell.  
Select **Yes** if the Home Run cable is connected to this cell.
- Next Node #**     Enter the cell address of the next cell in the network connected to the current cell. Default value is null; the drop-down box lists all available cells, plus a selection for **Termination**. Enter the cell address of the next load cell that the load cell cable is connected to in the network via the cell-to-cell cable. If this is the last load cell in the system (which contains the termination connector), select **Termination**.
- ESC**                Exits the screen without saving the values entered.
- Reset**       Resets the values shown on this screen. When pressed, a warning screen is displayed:

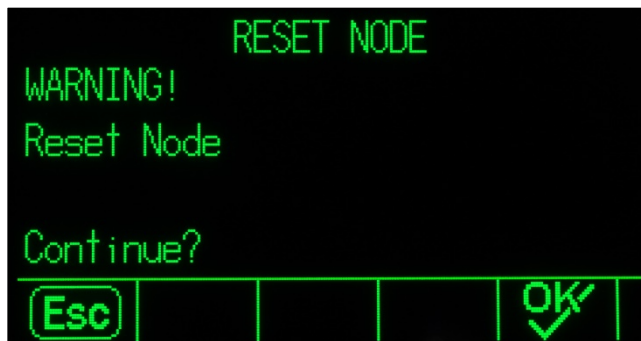

**Figure 3-33: Node Reset Warning**

- If **ESC** is selected, the screen is closed and the values are not reset.
- If **OK** is selected, both node values are reset to null, **HR Cable** to **No**, and a [Complete] message is shown. Press EXIT to return to the Node Edit screen.

OK 

Saves the settings and exits the screen, **only if**

- both Node parameters **have values** or
- both Node parameters are **null**

After all information has been entered correctly, a graphic describing each load cell address position displays. Below the graphic, the load cell connection sequence is shown beginning with the home run cable and finishing with the load cell that contains the termination connector. The information shown here can be used to better understand and locate specific load cell or load cell network errors.



Figure 3-34: Completed POWERCELL Load Cell Map

#### Reset

The **Reset**  softkey on the **POWERCELL Map** screen is used to reset the network graphic back to its initial (blank) state. When it is pressed, a warning screen is displayed:

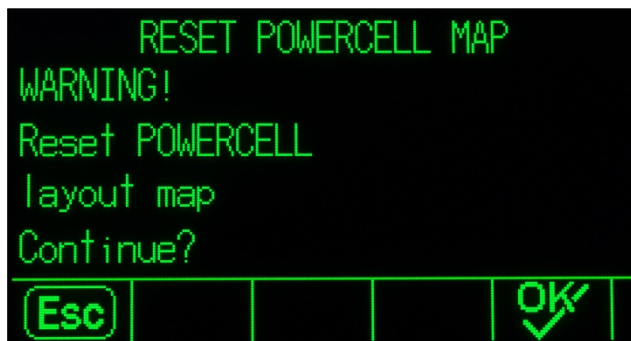

Figure 3-35: Map Reset Warning

- If **ESC** is selected, the display returns to the **POWERCELL Map** screen and the values are not reset.
- If **OK** is selected, all load cell positions are re-set, and the load cell sequence is cleared. A message of [Complete] is shown and the **EXIT** softkey must be pressed to return to the **POWERCELL Map** screen.

#### List View

Pressing the **List View**  softkey in the **POWERCELL Load Cell Map** screen displays a table view of the load cell network information. The table shows data for each cell from the home-run cable to

termination, as entered on the **Node Edit** screens (and displayed in the load cell map, Figure 3-34).

Location	Node	Position	HR	Next Node
Home Run	4	D	Y	2
Next Node	2	B	N	1
Next Node	1	A	N	3
Next Node	3	C	N	5
?	?	?	N	?

**Figure 3-36: Table View of POWERCELL Map**

Use the navigation keys to scroll through the table and display further nodes.

The **Position** column indicates the cell's physical location relative to the scale. Refer to Figure 3-31 for an explanation of the position letters.

**Example Sequence, Scale with Single 8-Cell Platform**

The following procedure describes the method for mapping a single-platform, eight-cell POWERCELL scale.

1. With the scale's cabling in place, sketch a map of the scale. The map should show the physical and cabling relationship between cells as seen from the point of view of the terminal or scale-house. The connection from the terminal to the first load cell should be shown, as well as connections between the load cells. In this example, the sketch might look like this:

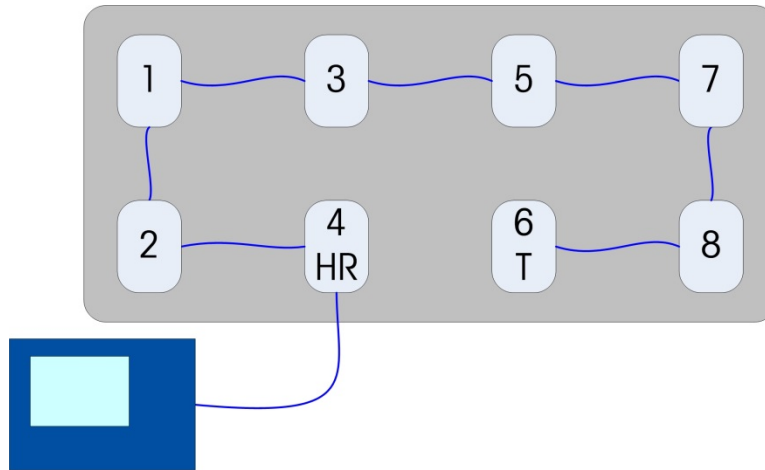

**Figure 3-37: Sketch of POWERCELL Network**

2. In setup, access **Maintenance > Configure/View > Scale > POWERCELL Map**.
3. The unconfigured map view will display, with each load cell represented by a question mark (?).



**Figure 3-38: Unconfigured POWERCELL Map**

4. Use the arrow keys to select the cell to which the home run cable is connected – the second in the bottom row in Figure 3-30 – and press the EDIT softkey. The Node Edit screen (Figure 3-32) will appear.
5. The sketch shows that this load cell is assigned address number 4, so select **4** from the **This Node #** dropdown list. The home-run cable is connected here, so the **HR Cable** value should be set to **Yes**. Finally, the next cell in sequence in the sketch is 2, so set **Next Node #** to **2**.
6. Press the OK softkey to confirm the settings.
7. In the cell map, use the arrow keys to select the next load cell in sequence – which the sketch indicates is node address 2. With that node selected, press the EDIT softkey. In the **Node Edit** screen, make the following settings:
  - This Node #: **2**
  - HR Cable: **No**
  - Next Node #: **1**
8. Press the OK softkey to confirm the settings. Repeat the process for cells 1, 3, 5, 7 and 8.
9. Finally, set cell 6 – the last cell in the network – as follows:
  - This Node #: **6**
  - HR Cable: **No**
  - Next Node #: **Termination**
10. Press the OK softkey to confirm. For this simple single-platform layout, the map (and the load cell sequence at the foot of the screen) will now resemble the one shown in Figure 3-34.
11. With the cell mapping complete, press the EXIT  softkey to return to the setup menu tree.

### **3.9.1.7. Calibration Management**

Calibration management includes a test interval to program how much time elapses or how many weighments should be completed between calibration checks. When this time or number of weighments is exceeded, an expiration action is initiated. The type of expiration action is also programmable. This feature is disabled by entering zeroes into both the number of days and number of weighments entry boxes.

Use the Calibration Management setup screen to configure parameters used for managing calibration activities.

## 3.9.1.7.1.

## Test Interval

Specify test intervals in days or weighments in the corresponding field text boxes.

The expiration action will be triggered when the first of either of these values is reached. For example, if 30 days and 3,000 weighments were programmed, as soon as 30 days or 3,000 weighments were exceeded (whichever were first), the expiration action would occur.

## 3.9.1.7.2.

## On Expiration

Use the On Expiration selection box to configure the activity to occur upon expiration of the calibration after the next test date or number of weighments occurs. Settings include:



- No Action
- Alarm Only (displays pop-up expiration message, triggers service icon, sends email)
- Alarm & Disable (displays pop-up expiration message, triggers service icon, sends email and disables the scale)

## 3.9.1.7.3.

## Last Date Tested, Next Test Date, and # of Weighments Left

The Last Date Tested and Next Test Date (if days is specified for intervals), or the number of weighments left until the next service (if weighments is specified for intervals), automatically calculate and display.

**To Reset the Last Date Tested to the Current Date**

1. Press the RESET softkey .
2. A warning message displays asking for verification that calibration management values are to be reset.
3. Press the OK softkey . A status screen displays that shows the reset process status. The Last Date Tested is reset to the current date. This reset also generates a recalculation of the Next Test Date and/or # of Weighments Left parameters if test intervals have been entered for these fields. Press the ESCAPE softkey **Esc** to return to the Calibration Management screen without resetting the values.
4. When a reset is successful, a verification message that reads "Values Reset OK" displays. If a reset is not successful, an error message that reads "Reset Failed" displays. Press ENTER to return to the Calibration Management screen.

**3.9.1.8.****Test Manager GWP**

Test Manager GWP includes a test interval that determines how much time elapses or how many weighments should be completed between GWP testing. When this time or number of weighments is exceeded, an expiration action is initiated. The type of expiration action is also programmable. Test Manager GWP is disabled by entering zeroes into both the number of days and number of weighments entry boxes.

- In order to run GWP tests from the GWP softkey on the home page, Test Manager GWP must be activated for each test that will be carried out.

The three branches under the GWP Management branch provide access to setup screens that allow independent configuration of test activity management for each GWP test. The branches are:

#### 3.9.1.8.1. Sensitivity, Eccentricity and Repeatability

The following setup parameters apply uniformly to all three branches under GWP Management.

##### Test Interval

Specify test intervals in days or weighments in the corresponding field text boxes.

The expiration action will be triggered when the first of either of these values is reached. For example, if 30 days and 3,000 weighments were programmed, as soon as 30 days or 3,000 weighments were exceeded (whichever were first), the expiration action would occur.

If 0 (zero) is entered into both these fields, or they are left blank, then Test Manager GWP is disabled for the specific test.

- **Note:** The weighment counter within Test Manager GWP does not increment when a custom print trigger or a print trigger specific to IND570 application pacs are used to initiate a demand output. The Test Manager GWP weighment counter only increments when the demand output trigger is set as Scale.

##### On Expiration



Use the On Expiration selection box to configure the activity to occur upon expiration of the GWP test period. Settings include:

- No Action
- Alarm Only (displays pop-up expiration message, triggers service icon and sends an email)
- Alarm & Disable (displays pop-up expiration message, triggers service icon, sends an email and disables the scale)

##### Last Date Tested, Next Test Date, and # of Weighments Left

The Last Date Tested and Next Test Date (if days is specified for intervals), or the number of weighments left until the next service (if weighments is specified for intervals), automatically calculate and display.

##### To reset the Last Date Tested to the current date

1. Press the RESET softkey .
2. A warning message displays asking for verification that management values are to be reset.
3. Press the OK softkey . A status screen displays that shows the reset process status. The Last Date Tested is reset to the current date. This reset also generates a recalculation of the Next Test Date and/or # of Weighments Left parameters if test intervals have been entered for these fields. Press the ESCAPE softkey  to return to the main menu without resetting the values.
4. When a reset is successful, a verification message that reads "Values Reset OK" displays. If a reset is not successful, an error message that reads "Reset Failed" displays. Press ENTER to return to the Sensitivity, Eccentricity or Repeatability Management screen.

#### 3.9.1.9. Calibration Test

The Calibration test provides a step by step scale test sequence to prompt the person performing the test through the stored test sequence. A test load with +/- tolerance is programmable for each step



along with two lines of prompting directions to guide the test person through each step. Up to 25 steps can be programmed for the sequence.



#### 3.9.1.9.1. Test Load Units





Use the Test Load Units selection box to select calibration test load units. Only weight units available for primary units are available for selection.

#### 3.9.1.9.2. Operator Test Weight Edit

Specifies if an operator can edit stored test weight information when accessed from the Run Calibration Test softkey  ↓ on the home screen. The selections are:

**Disabled** [default], **Enabled**

The entire calibration test sequence can be cleared by pressing the CLEAR softkey , then pressing OK  to confirm the action. When the calibration test sequence is cleared (empty), it still shows the –End– step. The –End– record will always display as the last step of the calibration test sequence. This field cannot be deleted and cannot be edited.

The Test Weight Info softkey  accesses pages where test weight information such as weight value and serial number can be entered. Use the UP and DOWN navigation keys to see the complete list. The edit softkeys will affect the specific record in focus. The entire test weight list can be cleared by pressing the CLEAR softkey , then pressing OK  to confirm the action. Press the ESCAPE softkey  to return to the Test Weight View screen without saving the changes to the test weight record.

Test weight records can be configured by:



Editing





Inserting



Deleting



#### To Edit a Test Weight Record

1. When the Test Weight View screen opens, the first test weight record in the list will have focus. Use the UP and DOWN navigation keys to select a test weight to edit.
2. Press the EDIT softkey  to open the setup screen for the test weight where edits can be made.
3. The test weight value and ID fields display. Edit the test weight value and ID as desired.
4. Press the OK softkey  to accept the test weight information as entered.
5. Press the ESCAPE softkey  to return to the Test Weight View screen without saving the changes.



#### To Insert a Test Weight Record

1. Use the UP and DOWN navigation keys to select the location in the test weight list where the new record is to be inserted.
2. Press the NEW softkey  to open the setup screen to create a new test weight record.
3. Enter the test weight value and ID information as desired.



4. Press the OK softkey  to store the current screen data. Any existing records move down one record to make room for the new record.
5. Press the ESCAPE softkey  to return to the Test Weight View screen without saving the record.

#### To Delete a Test Weight Record



1. Use the UP and DOWN navigation keys to select a record to delete. Press the DELETE softkey  to delete the step.
2. Press the EXIT softkey  to return to the Configure Calibration Test screen.
3. Press the VIEW TABLE softkey  to access the current calibration test sequence setup. The Calibration Test View screen displays.
4. When the Calibration Test View screen opens, the step numbers and their associated test loads, warning limit tolerances, control limit tolerances, and prompts display. Calibration test steps can be configured by:

 Editing



 Inserting

 Deleting

#### To Edit a Calibration Step

1. When the Calibration Test setup screen opens, the first step in the list will have focus. Use the UP and DOWN navigation keys to select a step to edit.
2. Press the EDIT softkey  to open the setup screen for the step where edits can be made.
3. The step's number and test load display first. Warning limit and control limit tolerance data are shown on the next page. Information for Prompt Field 1 and Prompt Field 2 (up to 33 characters per field that display as separate lines during the calibration test) display on the next screen. Edit the test step's test load, warning limit, control limit, and prompts as desired.
4. Press the OK softkey  to accept the calibration step parameters as entered.
5. Press the ESCAPE softkey  to return to the Calibration Test View screen without saving the changes to the calibration step parameters.

#### To Insert a Calibration Step

1. Use the UP and DOWN navigation keys to select the step in the calibration test procedure where the new step is to be inserted.
2. Press the NEW softkey  to open the setup screen to create a new calibration test step.
3. Enter the step's test load and tolerance data and information for Prompt Field 1 and Prompt Field 2.
4. Press the OK softkey . The current screen data is stored at the indicated step number, and any existing steps move down one record to make room for the new step.
5. Press the ESCAPE softkey  to return to the Calibration Test View screen without saving the calibration step.

Use the UP and DOWN navigation keys to select a step to delete. Press the DELETE softkey  to delete the step.

Press the PRINT softkey  to print the calibration test sequence to any connection with a Reports assignment.

Press the EXIT softkey  to return to the Configure Calibration Test screen.

### 3.9.1.10. GWP Tests

#### 3.9.1.10.1. Sensitivity

The Sensitivity test provides a step by step scale test sequence to prompt the person performing the test through the stored test sequence.

#### Test Load Units



Use the Test Load Units selection box to select sensitivity test load units. Only weight units available for primary units are available for selection.

#### Operator Test Weight Edit

Specifies if an operator can edit stored test weight information when the sensitivity test is accessed from the GWP softkey **GWP** on the home screen. The selections are:

**Disabled** [default], **Enabled**

Sensitivity test parameters and the stored sensitivity test sequence can be reset to default conditions by pressing the CLEAR softkey **C**, then pressing OK  to confirm the action.

The Test Weight Info softkey  accesses pages where sensitivity test weight information such as weight value and serial number can be entered. Use the UP and DOWN navigation keys to see the complete list. The edit softkeys will affect the specific record in focus. The entire test weight list can be cleared by pressing the CLEAR softkey **C**, then pressing OK  to confirm the action. Press the ESCAPE softkey **Esc** to return to the Test Weight View screen without saving the changes to the test weight record.

Test weight records can be configured by:



Editing



Inserting



Deleting

Refer to the **Calibration** Test section of Chapter 3, **Configuration** for instructions on editing, inserting and deleting a test weight record.

Press the VIEW TABLE softkey  to access the current sensitivity test sequence setup. For convenience, a 4-step default sensitivity test is stored in the terminal. This default test contains only user prompts, based on a GWP standard operating procedure for sensitivity testing. The default test does not include any test weight values or tolerances. These values must be entered manually.

Test load with warning limit +/- tolerance, control limit +/- tolerance is programmable for each step. The Warning Limit and Control Limit are single value entry boxes. They are shown with the units that are selected in the "Test Load Units" field. Units are not selectable in these setup fields. The two lines of default prompting instructions can also be modified.

When the Sensitivity Test View screen opens, the step numbers and their associated test loads, warning limit tolerances, control limit tolerances, and prompts display. Up to 25 steps can be programmed for the sensitivity sequence. Sensitivity test steps can be configured by:



Editing





Inserting



Deleting

Refer to section 3.9.1.9 **Calibration Test** for instructions on editing, inserting and deleting a sensitivity test step.

Press the PRINT softkey  to print the sensitivity test sequence to any connection with a Reports assignment.

Press the EXIT softkey  to return to the Configure Sensitivity Test screen.

#### 3.9.1.10.2. Eccentricity

The Eccentricity test provides for a step by step scale test sequence to prompt the person performing the test through the stored test sequence.

##### Test Load Units

Use the Test Load Units selection box to select eccentricity test load units. Only weight units available for primary units are available for selection.

##### Test Load

The Test Load field determines the single test weight value that should be used when executing the Eccentricity test. This value is for reference/recommendation only. The value of the test load has no impact on the results of the eccentricity test, as measurements taken during the eccentricity test are evaluated against the actual weight measurement of the first step of the eccentricity test and not against an absolute test load value.

##### Warning Limit

The Warning Limit +/- is a single value entry box shown with the units that are selected in the Test Load Units field. Units are not selectable in this setup fields.

##### Control Limit

The Control Limit +/- is a single value entry box shown with the units that are selected in the Test Load Units field. Units are not selectable in this setup fields.

##### Operator Test Weight Edit

Specifies if an operator can edit stored test weight information when the eccentricity test is accessed from the GWP softkey **GWP** on the home screen. The selections are:

**Disabled** [default], Enabled

Eccentricity test parameters and the stored eccentricity test sequence can be reset to default conditions by pressing the CLEAR softkey **C**, then pressing OK  to confirm the action.

The Test Weight Info softkey  accesses pages where eccentricity test weight information such as weight value and serial number can be entered. Use the UP and DOWN navigation keys to see the

complete list. The edit soffkeys will affect the specific record in focus. The entire test weight list can be cleared by pressing the CLEAR soffkey **C**, then pressing OK  to confirm the action. Press the ESCAPE soffkey (**Esc**) to return to the Test Weight View screen without saving the changes to the test weight record.

Test weight records can be configured by:



Editing

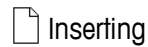

Inserting



Deleting

Refer to section 3.9.1.9 **Calibration Test** for instructions on editing, inserting and deleting a test weight record.

Press the VIEW TABLE soffkey  to access the current eccentricity test sequence setup. Up to 10 steps can be programmed for the eccentricity sequence.

For convenience, a 5-step default eccentricity test is stored in the terminal. This default test contains only user prompts, based on a GWP standard operating procedure for eccentricity testing that directs the user to place the test weight in 5 specific positions on the scale. The default test does not include any test weight values or tolerances. Only the two lines of default prompting instructions can be modified.

Eccentricity test operator prompts can be edited by using the EDIT soffkey.

Press the PRINT soffkey  to print the eccentricity test sequence to any connection with a Reports assignment.

Press the EXIT soffkey  to return to the eccentricity test setup screens.

### 3.9.1.10.3. Repeatability

The Repeatability test provides for a step by step scale test sequence to prompt the person performing the test through the stored test sequence. The repeatability test sequence is a specific number of repeated steps. Up to 20 repetitions of the same 2-step test sequence can be programmed for the repeatability sequence.

#### Test Load Units

Use the Test Load Units selection box to select eccentricity test load units. Only weight units available for primary units are available for selection.

#### Test Load

The Test Load field determines the single test weight value that should be used when executing the repeatability test. This value is for reference/recommendation only. The value of the test load has no impact on the results of the repeatability test, as measurements taken during the repeatability test are used to calculate a standard deviation of all measurements to determine a pass or fail of the repeatability test.

#### Warning Limit

The Warning Limit +/- is a single value entry box shown with the units that are selected in the Test Load Units field. Units are not selectable in this setup fields.

### Control Limit

The Control Limit +/- is a single value entry box shown with the units that are selected in the Test Load Units field. Units are not selectable in this setup fields.

### Number of Weighments



Defines the number of times an operator will be prompted to carry out the 2-step sequence of the stored repeatability test. Values from 1-20 can be accepted. This value will be multiplied by 2 in order to determine the total number of test steps. As an example, if 5 is set as the number of weighments, the user will be prompted through a total of 10 test steps.

### Operator Test Weight Edit

Specifies if an operator can edit stored test weight information when the repeatability test is accessed from the GWP softkey **GWP** on the home screen. The selections are:

**Disabled** [default], Enabled

Repeatability test parameters and the stored eccentricity test sequence can be reset to default conditions by pressing the CLEAR softkey **C**, then pressing OK  to confirm the action.

The Test Weight Info softkey  accesses pages where repeatability test weight information such as weight value and serial number can be entered. Use the UP and DOWN navigation keys to see the complete list. The edit softkeys will affect the specific record in focus. The entire test weight list can be cleared by pressing the CLEAR softkey **C**, then pressing OK  to confirm the action. Press the ESCAPE softkey **(Esc)** to return to the Test Weight View screen without saving the changes to the test weight record.

Test weight records can be configured by:



Editing



Inserting



Deleting

Refer to section 3.9.1.9 **Calibration Test** for instructions on editing, inserting and deleting a test weight record.

Press the VIEW TABLE softkey  to access the current repeatability test sequence. For convenience, a 2-step default repeatability test is provided. This default test contains only user prompts, based on a GWP standard operating procedure for repeatability testing. The first step of the default repeatability test assumes measurement with no test weight on the scale. The second step assumes the test weight is on the scale.

RepeatabilityThe test operator prompts can be edited by using the EDIT softkey.

Press the PRINT softkey  to print the repeatability test sequence to any connection with a Reports assignment.

Press the EXIT softkey  to return to the repeatability test setup screens.

### 3.9.1.11. InTouch<sup>SM</sup>

Activation of the embedded InTouch Remote Service communication agent is handled in this branch of the setup menu. The selections are:

**Disabled** [default], Enabled

The InTouch agent should not be enabled without the express permission of the user. Additional configuration, both internal and external of the terminal, is required for its proper function.

### 3.9.1.12. Reset

This Reset function affects setup values found only under **Maintenance > Configure/View**. Executing this reset will return all settings to factory defaults.

To initiate a reset, press the OK softkey . If the reset was successful, a verification message that reads "Reset Successful" displays. Press ENTER to acknowledge and return to the setup menu. If the reset was not successful, an error message that reads "Reset Failure" displays. If the reset fails, try to initiate the reset again. If the reset continues to fail, contact a local METTLER TOLEDO representative for assistance.

Press the ESCAPE softkey  to exit without resetting.

## 3.9.2. Run

The Run screens enable the operator to run the calibration test and GWP tests. In addition, various diagnostic data can be accessed and diagnostic tests carried out.

### 3.9.2.1. Calibration Test

#### 3.9.2.1.1. User ID







Entry of a User ID is required before the calibration test can be initiated. Press the ENTER key to enter the field and use the alphanumeric keys to enter a name. Press ENTER to accept the entry, or press the Exit softkey  to exit without saving.

The entered user ID is stored together with the calibration test result in the GWP Log. Refer to Appendix B, **Table and Log File Structure** for additional details on the GWP Log.





Stored calibration test weight information can be viewed by pressing the Test Weight softkey . If Operator Test Weight Edit is enabled (refer to **Operator Test Weight Edit** in section 3.9.1.10.2), the test weight information can be added or edited here.

#### To View and Modify Test Weight Information

1. Press the TEST WEIGHT INFORMATION softkey  to access the Test Weight View screen where test weight information such as weight values and serial numbers can be viewed, edited, inserted, or deleted.
  - If Operator Test Weight Edit is disabled, softkeys for editing, inserting and deleting will not be shown after the TEST WEIGHT INFORMATION softkey is pressed.

2. Press the EDIT softkey  to change a weight value or ID for a test weight, or press the NEW softkey  to insert a weight value and ID for a new test weight.
3. Press the OK softkey  to save the changes or the new test weight record.
4. Press the ESCAPE softkey **Esc** to exit without saving.
5. Press the DELETE softkey  to delete a test weight from the list.
6. To clear all test weight records from the list, press the CLEAR softkey **C**, then OK  to confirm the action.
7. Press the EXIT softkey  to return to the Run Calibration Test screen.

#### To Run the Calibration Test

1. Press the START softkey  to initiate the calibration test. The currently displayed weight unit is compared to the programmed calibration test procedure weight unit.
  - If the units in the calibration test do not match the units currently in use on the terminal a “Mismatched Weight Units” error is displayed. Press ENTER to acknowledge the error. Exit to the home screen and put the terminal into units that match the programmed Test Load Units.
2. Live scale weight (active weight) and mode displays on the first line (under the system line).
3. The calibration test step (for example, 1/5, which indicates step 1 of 5) displays under the active weight display.
4. The next line displays the test load value and control limit +/- tolerance values for the step.
  - Pressing the TEST INFORMATION softkey **i** will display additional details of the calibration test step, including: target weight, warning limit and control limit tolerance values.
5. Prompt 1 displays on the line under the test load. Prompt 2 displays on the next line.
6. Follow the prompts on the display and add the required test weights.
7. When ready, press the OK softkey  confirm the measured weight and proceed to the next calibration test step.
8. If a warning limit or control limit tolerance fails at any step, a Calibration Warning Limit Failure or a Calibration Control Limit Failure pop-up message displays. Press ENTER to acknowledge the error. There are now three possible steps:
  - a. If the wrong test weights were added to the scale, adjust the weights and press the OK softkey  to repeat the step.
  - b. If the test weights were correct and the scale needs to be recalibrated, press the EXIT softkey  to abort the calibration test.
  - c. Press the SKIP softkey  (a new softkey that displays when a Calibration Warning or Control Limit failure occurs), to accept the calibration test error and continue to the next step. If a Warning Limit Failure occurs, this is noted for this step in the test report, but is considered a passing step. If a Control Limit Failure occurs, this step of the test will report as a failure, but the test can be run to completion if desired.

9. Press the EXIT softkey  during any step to abort the calibration test and return to the Run Calibration Test screen.

After progressing through all of the steps in the calibration test procedure, a Test Complete message displays along with a Status message of either Pass or Fail. Press the PRINT softkey  to print the calibration test report to connections with a Report assignment. More details on the calibration test report are provided in the Reports section of Appendix C, **Communications**.

A basic test record is saved in the GWP log (if enabled) with additional details entered into the Maintenance Log (if enabled). For more details on the GWP or Maintenance Log, refer to Appendix B, **Table and Log File Structure**.

### 3.9.2.2. GWP Tests

#### 3.9.2.2.1. Sensitivity









##### User ID

Entry of a User ID is required before the sensitivity test can be initiated. Press the ENTER key to enter the field and use the alphanumeric keys to enter a new name. Press ENTER.

The entered user ID is stored together with the sensitivity test result in the GWP Log. Refer to Appendix C, **Table and Log File Structure** for additional details on the GWP Log.

Stored sensitivity test weight information can be viewed by pressing the Test Weight softkey . If Operator Test Weight Edit has been enabled (refer to section 3.9.1.9.2, **Calibration Test | Operator Test Weight Edit**), the test weight information can be added and edited here.





##### To View and Modify Test Weight Information

1. Press the TEST WEIGHT INFORMATION softkey  to access the Test Weight View screen where test weight information such as weight values and serial numbers can be viewed, edited, inserted, or deleted.
  - If Operator Test Weight Edit is disabled, softkeys for editing, inserting and deleting will not be shown after the TEST WEIGHT INFORMATION softkey is pressed.
2. Press the EDIT softkey  to change a weight value or ID for a test weight, or press the NEW softkey  to insert a weight value and ID for a new test weight.
3. Press the OK softkey  to save the changes or the new test weight record.
4. Press the ESCAPE softkey  to exit without saving.
5. Press the DELETE softkey  to delete a test weight from the list.
6. To clear all test weight records from the list, press the CLEAR softkey , then OK  to confirm the action.
7. Press the EXIT softkey  to return to the Run Sensitivity Test screen.

##### To run the sensitivity test

1. Press the START softkey  to initiate the sensitivity test. The currently displayed weight unit is compared to the programmed sensitivity test procedure weight unit.



- If the units in the sensitivity test do not match the units currently in use on the terminal a “Mismatched Weight Units” error is displayed. Press ENTER to acknowledge the error. Exit to the home screen and put the terminal into units that match the programmed Test Load Units.
2. Live scale weight (active weight) and mode displays on the first line (under the system line).
  3. The sensitivity test step (for example, 1/5, which indicates step 1 of 5) displays under the active weight display.
  4. The next line displays the test load value and control limit +/- tolerance values for the step.
  - Pressing the TEST INFORMATION softkey **i** will display additional details of the sensitivity test step, including: target weight, warning limit and control limit tolerance values.
  5. Prompt 1 displays on the line under the test load. Prompt 2 displays on the next line.
  6. Follow the prompts on the display and add the required test weights.
  7. Press the OK softkey  confirm the measured weight and proceed to the next sensitivity test step.
  8. If a warning limit or control limit tolerance fails at any step, a Sensitivity Warning Limit Failure or a Sensitivity Control Limit Failure pop-up message displays. Press ENTER to acknowledge the error. There are now three possible steps:
    - A. If the wrong test weights were added to the scale, adjust the weights and press the OK softkey  to repeat the step.
    - B. If the test weights were correct and the scale needs to be recalibrated, press the EXIT softkey .
    - C. Press the SKIP softkey  (a new softkey that displays when a Sensitivity Warning or Control Limit Failure occurs), to accept the sensitivity test error and continue to the next step. If a Warning Limit Failure occurs, this is noted for this step in the test report, but is considered a passing step. If a Control Limit Failure occurs, this step of the test will report as a failure, but the test can be run to completion if desired.
  9. Press the EXIT softkey  during any step to abort the sensitivity test and return to the Run Sensitivity Test screen.

After progressing through all of the steps in the sensitivity test procedure, a Test Complete message displays along with a Status message of either Pass or Fail. Press the PRINT softkey  to print the sensitivity test report to connections with a Report assignment. More details on the sensitivity test report are provided in the Reports section of Appendix C, **Communications**.

A basic test record is saved in the GWP log (if enabled) with additional details saved into the Maintenance Log (if enabled). For more details on the GWP or Maintenance Log, refer to Appendix B, **Table and Log File Structure**.

### 3.9.2.2.2. Eccentricity

#### User ID

Entry of a User ID is required before the eccentricity test can be initiated. Press the ENTER key to enter the field and use the alphanumeric keys to enter a new name. Press ENTER.

The entered user ID is stored together with the eccentricity test result in the GWP Log. Refer to Appendix C, **Table and Log File Structure** for additional details on the GWP Log.

Stored eccentricity test weight information can be viewed by pressing the Test Weight softkey **i**. If Operator Test Weight Edit has been enabled (refer to section 3.9.1.9.2, **Calibration Test | Operator Test Weight Edit**), test weight information can be added and edited here.



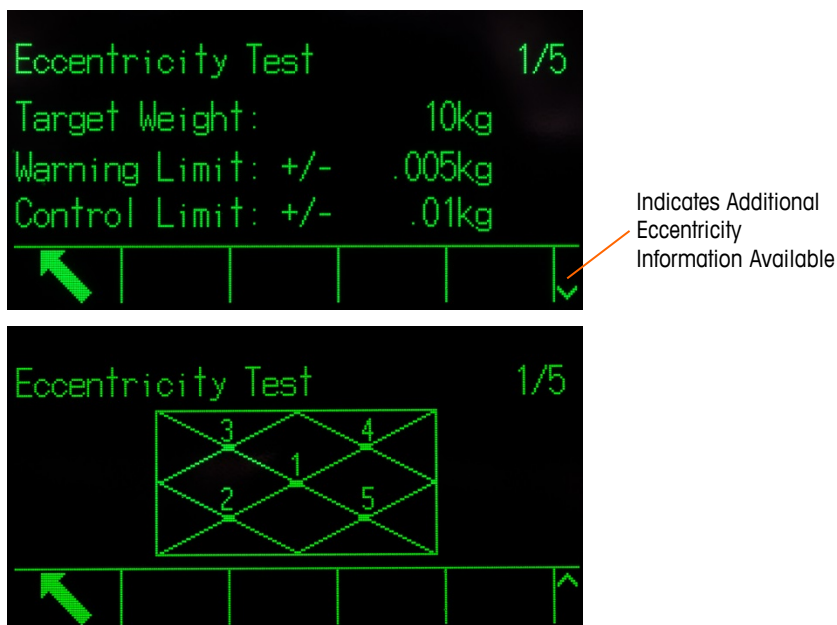

**To run the eccentricity test:**

1. Press the START softkey **⬅** to initiate the eccentricity test. The currently displayed weight unit is compared to the programmed eccentricity test procedure weight unit.
  - If the units in the eccentricity test do not match the units currently in use on the terminal a "Mismatched Weight Units" error is displayed. Press ENTER to acknowledge the error. Exit to the home screen and put the terminal into units that match the programmed Test Load Units.
2. Live scale weight (active weight) and mode displays on the first line (under the system line).
3. The eccentricity test step (for example, 1/5, which indicates step 1 of 5) displays under the active weight display.
4. The next line displays the test load value and control limit +/- tolerance values for the step.
  - Pressing the TEST INFORMATION softkey **i** will display additional details of the eccentricity test step, including: target weight, warning limit and control limit tolerance values and a diagram for test weight placement.



**Figure 3-39: Eccentricity Test Information Pages**

5. Prompt 1 displays on the line under the test load. Prompt 2 displays on the next line.
6. Follow the prompts on the display and add the required test weights.
  - Press the information softkey **i** at any time for a visual guide for test weight placement during the eccentricity test.

7. Press the OK softkey  confirm the measured weight and proceed to the next eccentricity test step.
8. If a warning limit or control limit tolerance fails at any step, an Eccentricity Warning Limit Failure or a Eccentricity Control Limit Failure pop-up message displays. Press ENTER to acknowledge the error. There are now three possible steps:
  - A. If the wrong test weights were added to the scale, adjust the weights and press the OK softkey  to repeat the step.
  - B. If the test weights were correct and the scale needs to be recalibrated, press the EXIT softkey  to abort the eccentricity test.
  - C. Press the SKIP softkey  (a new softkey that displays when a Eccentricity Warning or Control Limit Failure occurs), to accept the eccentricity test error and continue to the next step. If a Warning Limit Failure occurs, this is noted for this step in the test report, but is considered a passing step. If a Control Limit Failure occurs, this step of the test will report as a failure, but the test can be run to completion if desired.
9. Press the EXIT softkey  during any step to abort the eccentricity test and return to the Run Eccentricity Test screen.

After progressing through all of the steps in the eccentricity test procedure, a Test Complete message displays along with a Status message of either Pass or Fail. Press the PRINT softkey  to print the eccentricity test report to connections with a Report assignment. More details on the eccentricity test report are provided in the **Reports** section of Appendix C, **Communications**.

A basic test record is saved in the GWP log (if enabled) with additional details logged in the Maintenance Log (if enabled). For more details on the GWP or Maintenance Log, refer to Appendix B, **Table and Log File Structure**.

### 3.9.2.2.3. Repeatability



#### User ID



Entry of a User ID is required before the repeatability test can be initiated. Press the ENTER key to enter the field and use the alphanumeric keys to enter a new name. Press ENTER.

The entered user ID is stored together with the repeatability test result in the GWP Log. Refer to Appendix B, **Table and Log File Structure** for additional details on the GWP Log.

Stored repeatability test weight information can be viewed by pressing the Test Weight softkey . If Operator Test Weight Edit has been Enabled (refer to Operator Test Weight Edit in section 3.9.1.10.3), test weight information can be added or edited here.

#### To run the repeatability test

1. Press the START softkey  to initiate the repeatability test. The currently displayed weight unit is compared to the programmed repeatability test load unit.
  -  If the units in the repeatability test do not match the units currently in use on the terminal a "Mis-matched Weight Units" error is displayed. Press ENTER to acknowledge the error. Exit to the home screen and put the terminal into units that match the programmed Test Load Units.
2. Live scale weight (active weight) and mode displays on the first line (under the system line).

3. The repeatability test step (for example, 1/8, which indicates step 1 of 8) displays under the active weight display.
4. The next line displays the expected test load value and control limit +/- tolerance values for the step.
5. Prompt 1 displays on the line under the test load. Prompt 2 displays on the next line.
6. Follow the prompts on the display and add the required test weights.
7. Press the OK softkey  confirm the measured weight and proceed to the next sensitivity test step.
8. Press the EXIT softkey  during any step to abort the repeatability test and return to the Run Sensitivity Test screen.

Once all the steps in the repeatability test procedure are complete, if the repeatability Warning Limit or Control Limit has been exceeded a message will display indicating this failure. Press ENTER to acknowledge and move to the end screen.

A Test Complete message displays along with a test Status message, either **Pass** or **Fail**. Press the PRINT softkey  to print the repeatability test report to connections with a Report assignment. More details on the repeatability test report are provided in the Reports section of Appendix C, **Communications**.



A basic test record is saved in the GWP log (if enabled). Additional details are saved in the Maintenance Log (if enabled). For more details on the GWP or Maintenance Log, refer to Appendix B, **Table and Log File Structure**.

### 3.9.2.3. MT Service Security

The MT Service Security screen allows only a METTLER TOLEDO authorized service representative to unlock or lock access to the MT Service View and POWERCELL diagnostic functions. The terminal is in a locked state by default.

The serial number of the terminal is shown at the top of this screen and the security status is displayed at the bottom. The status will either be **Open** or **Secured**.

To unlock a Secured terminal:

1. Ensure that the Serial Number field on the screen is not blank. If it is blank, first enter the serial number of the terminal in the **Terminal > Device** setup screen before proceeding.
  2. Press the UNLOCK softkey  to access the Create MT Service Key screen.
  3. Press the OK softkey  to continue to the next step and generate a Lock String.
  4. A Lock String will appear on the screen. Press the DOWN navigation key to see the second page.
  5. The security status changes from **Secured** to **Awaiting Key** on the screen. At this point, it is necessary to provide a matching Key String (generated by an authorized version of the InSite CSL tool) to unlock the terminal.
- Press the ESCAPE softkey  to return to the setup menu tree if the Key String is not available. Make a note of the Lock String if the Key String will be generated later. The Lock

String will remain stored in the terminal until the user generates a new one.

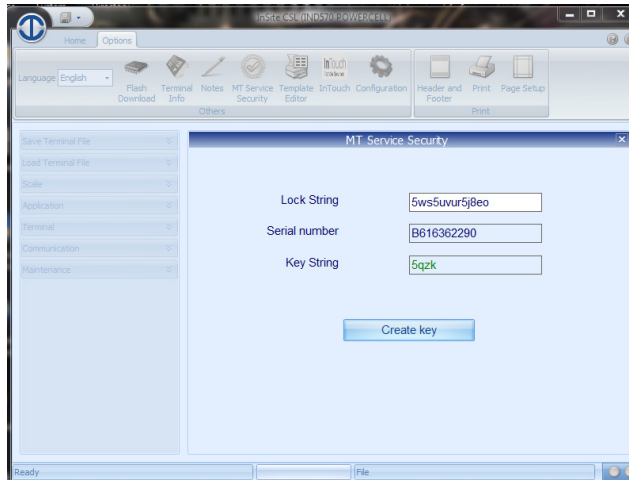

6. Use an authorized version of InSite CSL to create a Key String based on the Lock String created by the terminal. Within InSite, select IND570 POWERCELL, click on the **Options** tab. Then click on **MT Service Security**. Enter the Lock String generated by the IND570 into InSite. Clicking the **Create Key** button will generate a Key String that can then be entered into the IND570.





**Figure 3-40: Generation of Key String from InSite**

7. Enter the Key String, generated by the InSite CSL tool, into the Key String entry box of the terminal, and after pressing ENTER, press the OK softkey .
8. If the Key String is valid and accepted, the terminal will be unlocked and the security status is shown as "Open" on the screen.

If the Key String is not valid, an error message will be displayed and the user will be allowed to re-enter the key for a total of three attempts, after which a new Lock and Key String will need to be created.

9. Press the EXIT softkey  to return to the setup menu tree.
10. The UNLOCK softkey  can always be used to generate a new Lock String.

#### 3.9.2.3.1. To lock an Open terminal

1. Press the LOCK softkey  on the MT Service Security screen.
2. The security status on the display will change from **Open** to **Secured**.
3. Press the EXIT softkey  to return to the setup menu tree.

The terminal will automatically return to a locked state 36 hours after it has been unlocked.

When the IND570 is connected to InSite and the correct level of access is provided, the terminal can be unlocked automatically (using the MT Service Security link) without having to enter the terminal's setup mode.

### 3.9.2.4. MT Service View

The MT Service View screen allows a METTLER TOLEDO authorized service representative to view a variety of diagnostic data collected from a POWERCELL scale. More details on the diagnostics data are described in Chapter 4, **Service and Maintenance**.



The MT Service View screen is not accessible if the MT Service Security is locked – a pop-up message of "Function Disabled" will be shown. MT Service View screens include:

Load Cell (Information)	Scale - Temperature
Scale - Com Voltage	Terminal (Information)
Scale - Supply Voltage	

#### 3.9.2.4.1. Load Cell (Information)



The Load Cell information screen displays various diagnostics data for a selected POWERCELL load cell. Each data field will show both a value recorded at the time of calibration and a current value. This enables the user to make a comparison between current data and data from a known working condition of the cell. The displayed information includes:

Cell S/N (Serial Number)	CAN-High Dominant X (CANH DX)
Install Date	CAN-Low Dominant X (CANL DX)
Temperature	CAN-High Recessive (CANH R)
LC Supply Voltage	CAN-Low Recessive (CANL R)
Gas Concentration	

To access this screen from the MT Service View screen, select **Load Cell** in the Device selection box. Next, select the specific Load Cell number to view. Press the VIEW softkey  to proceed. Use the UP and DOWN navigation keys to scroll through each data field and the RIGHT and LEFT navigation keys to view data to the right and left. Press the EXIT softkey  to return to the MT Service View screen.



#### 3.9.2.4.2. Scale - COM Voltages

The Scale Load Cell COM Voltage screen displays the voltage levels on the CAN Bus communication lines for every POWERCELL load cell of the scale.

To access this screen from the MT Service View screen, select **Scale** in the Device selection box and **COM Voltage** in the View selection box. Press the VIEW softkey . A stop warning and confirmation screen will be displayed. Press the OK softkey  to proceed to display the Scale Load Cell COM Voltage screen. This operation will take several minutes as each load cell is required to interrupt its communication temporarily in order to take CAN voltage measurements. Press the EXIT softkey  to return to the MT Service View screen.



#### 3.9.2.4.3. Scale - Supply Voltage

The Scale Load Cell Supply Voltage screen displays the input supply voltage for the POWERCELL network.

To access this screen from the MT Service View screen, select **Scale** in the Device selection box and **Supply Voltage** in the View selection box. Press the VIEW softkey  to display the Scale Load Cell Supply Voltage screen. Press the EXIT softkey  to return to the MT Service View screen.



#### 3.9.2.4.4. Scale - Temperature

The Scale Load Cell Temperature screen displays the current temperature of each of the POWERCELL load cells.

To access this screen from the MT Service View screen, select **Scale** in the Device selection box and **Temperature** in the View selection box. Press the VIEW softkey  to display the Scale Load Cell Temperature screen. Press the EXIT softkey  to return to the MT Service View screen.

#### 3.9.2.4.5. Scale – Gas Concentration



The Gas Concentration screen shows the current gas concentration of each of the POWERCELL load cells.

To access this screen from the MT Service View screen, select **Scale** in the Device selection box and **Gas Concentration** in the View selection box. Press the VIEW softkey  to display the Scale Gas Concentration screen. Press the EXIT softkey  to return to the MT Service View screen.

#### 3.9.2.4.6. Terminal

The Terminal screen displays the minimum and maximum voltages and current detected on the IND570 terminal. The displayed information includes:

Minimum CAN-High Voltage	Maximum CAN Voltage Difference
Maximum CAN-High Voltage	Minimum Supply Voltage
Minimum CAN-Low Voltage	Maximum Supply Voltage
Maximum CAN-Low Voltage	Minimum Supply Current
Minimum CAN Voltage Difference	Maximum Supply Current

To access this screen from the MT Service View, choose **Terminal** in the Device selection box. Press the VIEW softkey  to proceed. Use the UP and DOWN navigation keys to scroll through each data field and the RIGHT and LEFT navigation key to view all fields. Press the EXIT softkey  to return to the MT Service View screen.

### 3.9.2.5. Diagnostics

Diagnostic test setup screens include Display Test, Keyboard Test, Scale, Serial Test, Discrete I/O Test, Reset Flash 2 and Reset Service Icon.

#### 3.9.2.5.1. Display Test

The Display Test screen displays an alternate off/on dot block pattern when first accessed. After the alternate off/on cycle, any additional test data about the display such as memory or program information displays.

Press the EXIT softkey  to return to the menu tree.

### 3.9.2.5.2. Keyboard Test

The Keyboard Test screen enables testing of the terminal keys, including softkeys, scale function keys, navigation keys and alphanumeric keys.

Press any key. The screen will display a symbol representing the key pressed.

Press the EXIT softkey  to return to the menu tree.

### 3.9.2.5.3. Scale

Possible scale diagnostics setup screens include Load Cell Output, Statistics and Calibration Values.

- Load Cell Output and Calibration Values are only available for analog and POWERCELL scale types.

#### Load Cell Output

The Cell Output screen displays the current number of counts (active value) for an analog scale. This display is not available for IDNet and SICSprö scale types. For a POWERCELL load cell network, the output of each cell is shown. If needed, use the UP and DOWN navigation keys to view all load cells.

Press the EXIT softkey  to return to the menu tree.

#### Calibration Values

The Calibration Values screen displays the current calibration values configured for the scale. This display is not available for IDNet and SICSprö scale types. The number of test loads that display calibration values is determined by the Linearity Adjustment setting configured for the scale (refer to section 3.5.1.3.4 (analog) or 3.5.4.4.4 (POWERCELL), **Linearity Adjustment**).

These calibration values can be recorded and then manually entered into a new replacement board should a failure ever occur. This makes it unnecessary to recalibrate the scale with test weights. While this method is quick, it is not as accurate as placing test weights on the scale.

Use the UP and DOWN navigation keys to select a calibration value to be modified. Use the numeric keypad to enter new values.

Press the EXIT softkey  to return to the menu tree.

#### Leveling Guidance (POWERCELL used with PowerDeck platform only)

The Leveling Guidance branch is only available if the **Scale > Type > Application** setting is **Floor** and the number of cells is **4**.

Press the EXIT softkey  to return to the menu tree.

The procedure for using this display is described in Chapter 5, **Service and Maintenance**.

#### Shift Values

The Shift Values screen displays the current shift adjustment values for a POWERCELL network. This display is available only for POWERCELL scale type. The number of shift adjustment values



displayed is determined by the selection of shift adjust by cell/pair and the quantity of load cells (refer to section 3.5.1.3.4 (analog) or 3.5.4.4.4 (POWERCELL), **Linearity Adjustment**).

These values can be recorded and then manually entered into a new replacement board should a failure ever occur. This makes it unnecessary to shift adjust the scale again. While this method is quick, it is not as accurate as placing test weights on the scale.

Use the UP and DOWN navigation keys to select a shift adjustment value to be modified. Use the numeric keypad to enter new values.

Press the EXIT softkey  to return to the menu tree.

### Statistics

The Scale Statistics screen displays statistical information for the scale such as weighments (increments each time a transaction is triggered), overloads (increments when the applied load for a single load cell exceeds its overload capacity), peak weight (the maximum weight recorded by the scale), and zero commands (increments each time a zero command is received from an operator or remotely).



Use the UP, DOWN, LEFT, and RIGHT navigation keys to view all information and records. Press the EXIT softkey  to return to the menu tree.

#### 3.9.2.5.4. Serial Test

The Serial Test screen enables testing of the sending and receiving hardware on the serial ports COM1, COM2, COM3 and COM4.

### Com Port

Use the Com Port selection box to select the serial port for testing (1, 2, 3, or 4).

Press the START softkey  to initiate transmission of the test string. After pressing START, the softkey changes to STOP . Press STOP to end transmission of the test string.

During the serial test, the terminal will transmit from the selected serial port a string "Testing COMX nn," where the "X" is the selected com port number (1, 2, 3, or 4) and "nn" is a sequential two-digit number (00–99). If a jumper wire is placed between the transmit and receive terminals on the serial port, the same data displays in the receiving field. If another device is connected to the receiving port, any ASCII data received will display in the receiving field.

The serial test continues until the STOP softkey  is pressed, which returns the user to the main Serial Test screen.

Press the EXIT softkey  to return to the menu tree.

#### 3.9.2.5.5. Discrete I/O Test

Discrete I/O Test setup screens include Local, Remote I/O 1, Remote I/O 2 and Remote I/O 3.







Select the internal (local) or external (Remote I/O) to be tested from the menu tree. Press ENTER.

- A pop-up message "Remote ARM100 communication failure" is shown if the ARM100 doesn't exist or is off-line due to error.

**VERY IMPORTANT!** When any of the Discrete I/O Test screens are first accessed, a warning message displays with instructions to remove output control power before proceeding with the test. The Discrete I/O Test screens enable manual setting of any of the outputs to ON or OFF for testing, so to avoid activating externally connected devices, **output control power must be removed** before proceeding.

Press the ESCAPE softkey  to abort and not perform the test.

**To continue the test:**

1. Press the OK softkey . A real-time display shows the status of each of the inputs and enables each of the outputs to be turned on and off. An input or output that displays  is turned off. An input or an output that displays  is turned on.
2. Use the LEFT and RIGHT navigation keys to select an output to turn on or off.
3. Press the DISCRETE OFF softkey  to turn the output off, and press the DISCRETE ON softkey  to turn the output on.
4. Press the EXIT softkey  to return to the menu tree. The outputs return to their previous ON/OFF status before the tests were initiated.

If three remote I/O modules are configured in the terminal, the IND570 disables the ability to run diagnostics on a local I/O board that may be installed.

#### 3.9.2.5.6. Network Test

If an Ethernet option is installed in the IND570, the Network Test screen enables Ethernet network testing and assists in determining the availability of network options. The status of each line associated with the network setup displays during and after testing, showing a status of either Testing, Pass, Fail, or Timeout.

Press the EXIT softkey  to return to the menu tree.

#### 3.9.2.5.7. WiFi Scan

If the WiFi option is installed, this screen provides a means to scan for available WiFi network access points and see which has the strongest signal. Press START  to begin the scan. The scan will take several seconds.

After the scan is complete, a maximum of 10 access points with the strongest signal strengths are displayed, including the channel used and signal strength. The access point with the strongest signal will be listed first.

#### 3.9.2.5.8. Reset Flash 2

The Reset Flash 2 function clears the Flash 2 memory of all program files, custom tables and bitmap files specific to TaskExpert custom programs that have been downloaded to the terminal. Only the A1.csv (Tare Table), A2.csv (Target Table), A3.csv (Container Tare Table present in the Fill-570 only) and A4.csv (Formula Table present in the Fill-570 only) will remain in place with intact structures during reset of the Flash 2 drive.

Press the START softkey  to initiate a reset of the Flash 2 memory. The terminal will NOT prompt the user for confirmation and the reset will begin immediately. A "Reset successful" pop-up will

appear when the reset is complete. Press ENTER to acknowledge. At this time, the terminal will complete a power cycle.

Press the EXIT softkey  to cancel the reset and return to the **Maintenance > Run** screen.

#### 3.9.2.5.9. Reset Service Icon

Select OK to confirm the reset of the Service Icon. The Service icon will no longer display on the terminal's main screen. Press the ESCAPE softkey  to cancel the reset.

#### 3.9.2.5.10. Restore Scale Data (POWERCELL used with PowerDeck only)

This function is only available if the **Scale > Type > Application** setting is **Floor** and the number of load cells is **4**.

Selecting OK starts a restore of all scale data stored in the PowerDeck's load cells during original factory calibration. After pressing OK, a "Working" message will appear until the restore is complete. Press the ESCAPE softkey  to cancel the reset and return to the main menu.

Additional information on the Restore Scale Data function is provided in Chapter 5, **Service and Maintenance**.

#### 3.9.2.6. Replace Battery

Replacing the battery on the main PCB, without a data backup, will cause the volatile data stored in BRAM (battery backed memory) to be lost. The Replace Battery function provides a way to securely change out a weak battery in the IND570 without losing BRAM memory.

Press the START softkey  to initiate a BRAM backup prior to battery change. The terminal will NOT prompt the user for confirmation and the backup to Flash memory will begin immediately. A "Working" message will appear while the backup is in process.

After a successful backup, the display message changes to "Backup Complete. Power off terminal and replace battery." Press EXIT . When power is restored after battery replacement, the terminal will automatically restore the BRAM data from the backup file.

#### 3.9.2.7. Install Upgrade

Refer to Chapter 5, **Service and Maintenance**, for the procedure to follow when upgrading software from a USB stick.

	 <b>WARNING</b>
	<b>THE USB INTERFACE IS NOT CERTIFIED FOR USE IN DIVISION 2 OR ZONE 2/22 HAZARDOUS AREAS. USE ONLY IN SAFE AREA.</b>

#### 3.9.2.8. Install Base Upgrade

When a SICSpro type of platform is connected, this step will allow upgrading of the firmware in the load cell. Refer to Chapter 5, **Service and Maintenance**, for the procedure to follow when upgrading base software from a USB flash drive.

### 3.9.2.9. Backup to USB

The system Backup to USB function facilitates the storage of terminal setup and calibration data onto a USB memory module connected to the terminal.

Select the data to be backed up in the Backup selection box. Choices include:

**Calibration** [default], Configuration, TaskExpert (program and bitmap files), Templates

Refer to Chapter 5, **Service and Maintenance**, and Chapter 4, **Applications**, for additional information on backing up the system configuration. Backup to USB can be carried out even when the terminal is metrologically sealed.

### 3.9.2.10. Restore from USB

The system Restore from USB function allows a dataset saved on a USB memory device to be restored to the original terminal or copied to a new terminal. Select the data to be restored (from a previous save function) from the Restore selection box. Choices include:

**Calibration** [default], Configuration, TaskExpert (program and bitmap files), Templates

If the tables AO.csv – A9.csv are present in the backup file, they will be restored to the terminal. Log files (Alibi, Maintenance, Change, and GWP) are not restored in this process. Configurations cannot be restored or copied to indicators that are metrologically sealed.

Refer to Chapter 5, **Service and Maintenance**, and Chapter 4, **Applications**, for additional details and requirement regarding the restore of data from a USB memory device.

## 3.9.3. Reset All Factory Defaults

Use the Reset All under the Maintenance branch to restore all setup parameters to factory defaults.

- The Reset All function resets all parameters in the terminal, except metrologically significant settings such as Scale type, capacity, etc.

When the Reset All screen is first accessed, a message displays that asks for verification to reset all setup parameters to factory default settings. To continue with the Reset All, press the OK softkey . If the reset is successful, a verification message that reads “Reset Successful” displays. If the reset is unsuccessful, an error message that reads “Reset Failure” displays. If the reset fails, try to initiate the reset again. If the reset continues to fail, contact a local METTLER TOLEDO representative for assistance.

Press the ESCAPE softkey  to exit without resetting.



### 3.9.3.1. Reset Branches to Factory Defaults

Factory default settings can be restored for individual branches in the setup menu such as Scale, Application, and Terminal. The Reset screen is the last branch in each major branch of the menu tree (except for Maintenance). To restore factory default settings for an individual branch, for example Terminal:

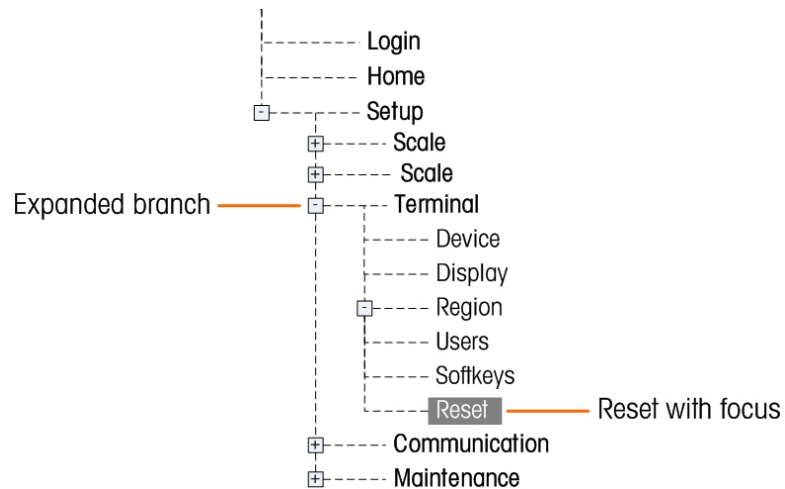
1. Press the SETUP softkey . The setup menu tree (Figure 3-41) displays.



**Figure 3-41: Setup Menu Tree – Reset**

2. Use the DOWN navigation key to move the focus to Terminal.
  3. Press the RIGHT navigation key to expand the Terminal branch.
  4. Use the DOWN navigation key to move the focus to Reset.
  5. Press the ENTER key to open the Terminal Reset screen.
  6. Press the OK softkey  to reset the Terminal setup values to factory default settings.
  7. A status message appears that verifies a successful reset.
  8. Press the EXIT softkey  to return to the setup menu tree display.
  9. Repeat steps 2–8 to reset factory default settings for any major branch in setup.
- Note that the Reset function under the Scale branch does not include the reset of metrological parameters such as scale type, capacity, increment, or calibration data. Reset of metrological data can only be carried out with a Master Reset. Refer to Chapter 5, **Service and Maintenance**, for information on executing a Master Reset of the terminal.

# 4 Applications

This chapter covers

- Hands-Off Operation
- Print to USB
- Comparators
- ID Prompting
- Information Recall
- Remote Terminal
- Simple Filling

This chapter summarizes setup steps necessary to configure certain common terminal applications, and includes examples of how each application might be used.

## 4.1. Hands-off Operation: Automatic Tare and Automatic Print

### 4.1.1. Overview

With the IND570 terminal, it is possible to take a container tare automatically, display the net weight of a product added to the container and then print the results without touching the keypad of the terminal. This application can save the operator from repetitive actions and streamline an operation.

Depending on the needs of the application, the automatic tare or automatic print can each be used separately. No keypad or keyboard entry is required for this operation – the process operates completely hands-off.

### 4.1.2. Operational Features

In addition to the fundamental weighing functions, the following features can also be used to enhance the hands-off operation.

#### 4.1.2.1. ID1 – ID4

The identification feature of the IND570 can be used to input information specific to this transaction such as operator name, product code, etc. Up to four different sequences can be defined to help guide operation actions. A bar code scanner could be used to enter this data to also make it a hands-off function at the terminal. The identification features are described earlier in this chapter.

#### 4.1.2.2. Transaction Counter

The transaction counter is a 7 digit value that increments each time a print is triggered. Adding this field to the print template provides a mechanism to identify each transaction with a unique number. Operation of the transaction counter is described in Chapter 2, **Operation**.

#### 4.1.2.3. Time and Date

Time and date fields can be included in the printed data by adding them to the print template. This information provides a time reference for the transaction. Various formats are selectable during configuration of this feature. The time and date feature is described in Chapter 2, **Operation**.

#### 4.1.2.4. Totalization

The IND570 terminal provides grand total and subtotal registers to totalize weight values as they are printed. The registers can accumulate either gross or net weight as defined in setup and a separate report of the total values is possible. Operation of the totals registers is described in Chapter 2, **Operation**.

### 4.1.3. Configuration

In order for the automatic tare and automatic print functions to operate properly for an application, some parameters must be configured. These parameters are described in this section. Note that in order for a print to occur, a demand output connection with a Scale trigger must be configured. Details on configuring a demand output can be found in Chapter 3.

#### 4.1.3.1. Automatic Tare

In the setup mode of the terminal, automatic tare is programmed at **Scale > Tare > Auto Tare**.

##### 4.1.3.1.1. Auto Tare

The **Automatic Tare** feature must first be **Enabled** in order to access the parameters associated with it. Options are Disabled or Enabled. The default value is **Disabled**.

##### 4.1.3.1.2. Tare Threshold Weight

This parameter determines how much gross weight must be detected on the platform before the automatic tare function is triggered. This value should be slightly less than the minimum tare value required for the application. When any weight above this value is detected on the platform and a no motion condition exists, a tare will automatically be taken.

##### 4.1.3.1.3. Reset Threshold Weight

After an automatic tare has occurred, the terminal must re-arm the trigger before the next automatic tare can occur. The **Reset Threshold Weight** parameter sets the gross weight value below which the weight on the platform must return to re-arm the automatic tare function. If the weight does not drop below this value, a new automatic tare will not be initiated. This value should be a few increments above zero to make sure that the previous product weighed has been removed and the terminal is ready for the next cycle.

#### 4.1.3.2. Motion Check

The motion check setting can be used to restrict the re-arming of the auto tare trigger. When enabled, the terminal must detect a no-motion condition with gross weight below the **Reset Threshold Weight** value to re-arm the trigger. Options are **Disabled** or **Enabled**. The default value is **Disabled**.

#### 4.1.3.3. Automatic Print

In the setup mode of the terminal, the automatic print feature is programmed at **Scale > Log or Print**.

#### 4.1.3.4. Minimum Weight

The **Minimum Weight** setting is the gross weight threshold below which an automatic print function will not initiate. The value entered must be greater than the maximum empty container weight (so auto print does not get initiated when the empty container is placed on the scale) and less than the minimum final gross weight to be printed (so the lightest full weight will still initiate the automatic print). If this value is less than the maximum tare weight used, when that empty container is placed on the scale, an automatic print would be initiated and since the auto print cycle had already been activated, printing of the final filled weight would not be initiated.

#### 4.1.3.5. Interlock

The **Interlock** parameter prevents repeat printing without a significant change in weight. Options are **Disabled** or **Enabled**. The default value is **Disabled**. For automatic printing, this parameter should be **Disabled** since the interlock function is controlled by the automatic print function.

#### 4.1.3.6. Automatic

The **Automatic** setting must be set to **Enabled** to initiate a print automatically when weight is placed on the platform. Every time the weight on the scale settles to a positive value that is larger than the entered **Threshold Weight** value, a print will be initiated.

If **Automatic** is **Disabled**, the **Threshold Weight** field does not appear.

#### 4.1.3.7. Reset on

Re-arming of the Auto print function can be programmed to operate on either a return to below a preset weight value or after a preset deviation in weight. Select **Return** if the re-arming of the auto print feature should require the gross weight to return to below a preset weight value. **Deviation** mode requires a change in the gross weight value beyond a preset weight value to re-arm the auto print feature. For this application, select **Return** from the selection box, then enter a weight value equal to a few display increments in the adjacent weight entry field.

If **Reset On** is set to **Deviation**, the **Threshold Weight** and **Motion Check** fields do not display.

#### 4.1.3.8. Threshold Weight

The **Threshold Weight** parameter programs the gross weight value above which the weight must settle to initiate the automatic print function. This value should be greater than the maximum tare value so a false print does not initiate when an empty tare container is placed on the platform.



**Threshold Weight** does not appear if **Reset on** is set to **Deviation**.

#### 4.1.3.9. Motion check

The motion check setting can be used to restrict the re-arming of the auto print function when **Reset on** is selected as **Return**. When **Enabled**, the terminal must detect a no-motion condition with gross weight below the **Reset on weight** value to re-arm the trigger. Options are **Disabled** and **Enabled**. The default value is **Disabled**.

**Motion Check** does not appear if **Reset on** is set to **Deviation**.

#### 4.1.4. Operating Sequence

The following steps describe a simple weighing application that includes both an automatic tare function and an automatic print function.

1. Place an empty container on the platform.
2. When motion settles and the gross weight is above the programmed auto tare **Threshold**, a semi-automatic tare is taken. The net weight of zero is shown.
3. Place a load into the container.
4. When motion settles and the gross weight is above the **Minimum Weight** value and above the automatic print **Threshold Weight**, an automatic print is initiated.
5. Remove the filled container from the platform.
6. The gross weight falls below the auto tare **Reset Threshold Weight** and below the auto print **Reset on Return** weight. Both the automatic tare and automatic print functions are re-armed.
7. Repeat steps 1 through 6 as required.

## 4.2. Print to USB



A Demand Print connection can be configured to print to a connected USB drive. This is useful for tasks such as daily data collection. The status of the USB device will be shown in the Terminal Status Report view. This is accessed from the home screen by pressing **Information**  > **Service**  > **Service Information Recall** .



Figure 4-1: Terminal Status Report – USB Memory

## NOTICE

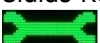
THE USB INTERFACE IS NOT CERTIFIED FOR USE WITHIN DIVISION 2 OR ZONE 2/22 HAZARDOUS AREAS.

### 4.2.1. Connection and Template Configuration

To set up printing to USB, first create a demand print connection (in setup at **Communication > Connections**). Assign it a trigger (Scale, or custom trigger 1, 2 or 3) and a template (1 to 10).

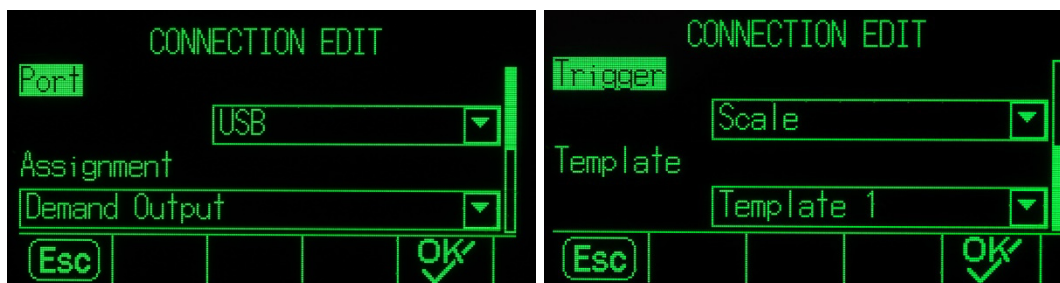

Figure 4-2: Creating a Connection

The selected template can be edited (in setup at **Communication > Templates > Output**). Note that the template is limited to 1,000 bytes, but can include XML tagging, as well as the other elements detailed in section 3.8.3.2., **Output**, in Chapter 3, **Configuration**.

### 4.2.2. Memory Limits

With the output and template configured, each time the trigger condition is met the terminal will write the template to the USB memory. The file will be named **Demand-Temp $n$ .txt**, where  $n$  is the template number. Each trigger event adds a record to the file – that is, it appends the print below the previous prints in the file.

The IND570 tracks the remaining space on the USB memory device, and displays warnings when the device is 75% and 90% full. Each template file is limited to 5MB. When any template file is at 75% or 90% of its capacity, a warning will display.

The IND570 tracks the remaining space on the USB memory device, and displays warnings when the device is 75% and 90% full.



Figure 4-3: USB Capacity Warning Message

Once the template file is completely full, no further records will be added and an error message indicating no further prints can be collected will be displayed.

## 4.3. Comparators: Configuration and Operation

### 4.3.1. Overview

Comparators are simple targets that operate by comparing the live rate or live weight to either a specified threshold value or a specified range. To use a Comparator, it must be assigned to a discrete output. The assigned discrete output will turn on or off based on the relationship of the rate or weight to the limit or range. More details of the comparators can be found in Chapter 2, **Operation**.

### 4.3.2. Operational Features

In addition to the fundamental weighing functions, the following features can also be used to enhance the operation of the comparators.

#### 4.3.2.1. Discrete outputs

The discrete outputs extend the comparator operation from a logical comparison to actually control equipment. External equipment can be turned on or off based on the status of the comparator. Devices such as lights, alarms or feeders can be controlled to provide operator input or to provide total system control.

#### 4.3.2.2. Discrete inputs

When a discrete output for a comparator is connected to a discrete input, certain functions such as blanking the display or disabling the keypad can be triggered based on the weight on the scale.

#### 4.3.2.3. TaskExpert

TaskExpert programs can monitor the status of a comparator to obtain information required for an application. The terminal also allows a TaskExpert program to control a comparator directly based on parameters it provides. This allows a comparator to operate based on limits that may relate to other application values and not just directly related to rate or weight.

#### 4.3.2.4. Application Example

■ Refer to section 4.4 for information on ID prompting.

This example application includes a tank scale calibrated as 500 x 0.1 kg. When the gross weight drops below 50kg, a yellow warning light should be turned on. If the weight drops below 30kg, a red alarm light should also be turned on.

The operator is instructed that when the yellow light turns on, they should manually refill the tank at the first opportunity. If the red alarm light turns on, the operator is instructed to immediately stop what they are doing and refill the tank.

During the manual refill process, there should be a green light that turns on when the gross weight is at least 450kg or more to indicate the refill process is complete.

### 4.3.3. Configuration

In order for comparators to operate properly for an application, some parameters must be configured. These parameters are described in this section.

#### 4.3.3.1. Comparators

In the setup mode of the terminal, the comparators are programmed at **Application > Operation > Comparators**.

When first entering the comparator branch of setup, a list of the programmed comparators will be shown. Softkeys on this page provide access to editing of the parameters, deleting a comparator or clearing all comparators. Focus on the desired Comparator then press the EDIT softkey to enter parameters for that comparator. Below the description of each of these parameters, a table shows how each comparator should be programmed.

#### 4.3.3.2. Source

This selects the source of the value that will be used for comparison to the limit or range in order to turn the comparator on or off. Choices include **None** (disables comparator), **ABS-Displayed Weight** (absolute value of displayed weight), **ABS-Rate** (absolute value of the rate), **Application** (used for TaskExpert applications), **Displayed Weight**, **Gross Weight** and **Rate**.

#### 4.3.3.3. Active

The comparator behavior is selected in this step. Choices include < (less than), <= (less than or equal to), = (equal to), >= (greater than or equal to), > (greater than), < > (not equal to), <\_>\_ (outside a range and <\_> (within a range). When the active rate or weight value meets the active criteria compared to the limit value

#### 4.3.3.4. Description

The description is an alphanumeric string that is used to identify the type and purpose of the comparator. The maximum length is 20 characters.

#### 4.3.3.5. Limit

The Limit sets the comparison value to which the actual source value (gross weight in this example) is compared.

### 4.3.4. Comparator Programming Example

To program the comparators for the application example, the following values should be programmed for comparators 1 through 3.

**Table 4-1: Example Application Programming of Comparators**

Comparator	Source	Active	Description	Limit
1	Gross	<=	Yellow light	50
2	Gross	<=	Red light	30
3	Gross	>=	Green light	450

#### 4.3.4.1. Discrete Outputs

In the setup mode of the terminal, the discrete outputs are programmed at **Application > Discrete I/O > Outputs**.

When first entering the discrete output branch of setup, a list of the programmed outputs will be shown. Softkeys on this page provide access to editing of the parameters, deleting an assignment or clearing all assignments. Press the NEW softkey to enter parameters for a new discrete output. The setup steps for programming a discrete output are shown next. After the description of the setup parameters, a table shows how the three required discrete outputs should be programmed.

#### 4.3.4.2. Address

The address defines which set of inputs and outputs of the terminal will be assigned to a function. There are internal discrete inputs/outputs and remote discrete inputs/outputs. The remote I/O is provided via up to three ARM100 devices. The internal I/O is available in different combinations of serial ports, discrete inputs and discrete outputs. It is important to decide which set of I/O will be used and then the address is simply entered to identify the specific I/O.

Each address consists of three digits that indicate internal or external I/O, which remote module if a remote I/O module is selected and then finally which physical input or output point on that module will be used.

#### 4.3.4.3. Assignment

Using this parameter permits assignment of a logical feature (such as a comparator) to a physical output. For each discrete output address entered, there is a long list of possible assignments to scroll through. The complete selection list can be found in Chapter 3, **Configuration**.

#### 4.3.4.4. Discrete I/O Programming Example

To meet the requirements of the application example above, three discrete output assignments must be made for the internal I/O option. After the green, yellow and red lights are wired to the associated discrete outputs, these assignments will allow the discrete outputs to turn the required colored lights on and off at the appropriate time as described in the next section.

**Table 4-2: Example Application Programming of Discrete Outputs**

Output Address	Assignment	Connection
0.1.1	Comparator 1	Yellow light
0.1.2	Comparator 2	Red light
0.1.3	Comparator 3	Green light

#### 4.3.5. Operating Sequence

To start the operating sequence, let's assume the weight in the tank is approximately 100kg and all the lights are off. As material is removed from the tank, eventually the weight reaches 50kg.

At this point, because the actual weight is less than or equal to the comparator 1 limit of 50kg, comparator 1 turns on which in turn causes the discrete output 1 to turn on. The yellow light is wired to output 1 so the yellow light is illuminated.

The operator does not immediately refill the tank so the weight continues to drop. Eventually the weight falls to 30kg.

At this point, because the actual weight is less than or equal to the comparator 2 limit of 30kg, comparator 2 turns on which in turn causes the discrete output 2 to turn on. The red light is wired to output 2 so the red light is illuminated.

The operator now notices that both the red and yellow lights are on so he immediately begins to manually refill the tank. As soon as the weight exceeds 30kg, comparator 2 turns off and the red light turns off. The yellow light remains on until the weight exceeds 50kg and then it turns off.

The operator continues to refill the tank and when the actual weight exceeds 450kg, comparator 3 turns on which in turn causes the discrete output 3 to turn on. The green light is wired to output 3 so the green light is illuminated. As soon as the operator notices the green light is on, he stops the manual refill.

The tank is now full and as material is removed, the weight will fall below the 450kg refill limit and the green light will turn off. All lights will remain off until the weight reaches 50kg at which time the yellow light turns on warning the operator to refill the tank again. This cycle will continue for as long as required.

## 4.4. ID Prompting

### 4.4.1. Overview

The ID1, ID2, ID3 and ID4 function are simple but powerful means of facilitating specific data input from the operator or causing a specific action to take place. The ID prompt list may include up to 30 steps, each step containing a command that determines the action the IND570 terminal will take when the step is executed.

All four sequences can be programmed to run through once or to loop continuously until terminated. All IDs can be initiated by the pressing the appropriate ID softkey. ID1 can also be initiated and restarted automatically, triggered by weight input from the scale. In either case, the IDs prompt the operator to work through a series of actions or data entries. For example, the operator could place a package on the scale, be prompted to enter his or her name, enter a pre-set tare value, scan a bar code on the package, and generate an automatic print before finally removing the package from the scale. The printed data could include the net weight value, together with the scanned package information and the operator's name. The content and format of the printed information is determined by the template assigned to the demand output.

### 4.4.2. Configuration

For an ID prompt to work, its ID Mode must be enabled in setup, at **Application > Operation > ID1, ID2, ID3 or ID4.**

#### 4.4.2.1. Selecting a Mode

For ID1, choose between **Automatic** and **Softkey** modes.

When ID1 is set to **Automatic mode**, the ID sequence is triggered when the weight on the scale exceeds the threshold configured in the **Threshold** field. The sequence trigger is rearmed when the

weight falls below the **Reset** value. The **Threshold** value should represent a weight which, when placed on the scale, appropriately indicates that the sequence is starting. The **Reset** value should be a considerably smaller value, but not zero, so that scale weight can be expected to fall below it when the sequence of operations is complete.

All IDs can use **Soffkey** mode. In this mode, the prompting sequence begins to run when the appropriate soffkey (ID1, ID2, ID3 or ID4) is pressed, and either runs once (if **Looping** is **Disabled**) or runs continuously (if **Looping** is **Enabled**).



#### 4.4.2.2. Setting up Prompts

Once the mode has been selected for an ID, press the **ID Search** soffkey  at the center of the soffkey row in the ID configuration screen. A search field will open; if many different sequences are programmed for the ID, it can be helpful to narrow the search by selecting **#**, **Type**, **Length** or **Prompt** as the search object (each of these is an attribute of all ID elements), then using one of the comparative operators – **<**, **<=**, **=**, **=>**, **>** or **≠** – in combination with a value entered in the data entry field, to filter the selection.

Alternatively, leave the asterisk in the data entry field to display all ID records associated with this ID number.

Press the **Search** soffkey  to display the results.

The ID View screen will show each configured record, with its serial number at left. Use the arrow keys to scroll down or up through the list.

Each record can be **Edited**  or **Deleted** , and **New** records can be created . The same options are available for both editing and creating records, and they are:

- Type** Select from the input options: **Alphanumeric**, **Clear Tare**, **Numeric**, **Print**, **Selection List**, **Tare – Auto** and **Tare – Preset**. The remaining configuration options available change depending on the selection made here.
- If the input is set to **Alphanumeric**, **Numeric** or **Tare – Preset**, the further options are **Prompt**, **Length** and **Clear Data**:
- Prompt** This is the text that will appear on screen, which can be an instruction to the operator, or a reminder of the current stage of the operation.
- Length** The number entered here defines the maximum length of the data – alphanumeric or numeric – that the operator can enter. This can help to ensure that the appropriate information, such as a lot number, is entered.
- If the input is **Alphanumeric** or **Numeric**, then the operator is free to enter either any characters or numbers only, up to the limit permitted by the **Length** value.
- If the input is **Tare – Preset**, then the a typical Prompt might be “Enter a pre-set tare value now,” and the Length would define the appropriate number of digits in that value.
- If **Length** is set to zero, then the only an operator instruction displays, and no data can be entered. The **Clear Data** field has no effect in this case. The operator must press ENTER to move to the next step in the sequence.

**Clear Data** If **Clear Data** is **Enabled**, the data the operator selected or entered is cleared at the end of the ID sequence. If it is **Disabled**, the entered data is saved for the next sequence; the operator can overwrite the field of data (where data entry is permitted), or can choose to keep it – which is useful if some items (such as the Operator’s name, or a batch number) are likely to be the same from one sequence to the next.

If the input is set to **Clear Tare, Print or Tare – Auto**, then no further configuration is allowed; at this point in the sequence, the terminal will simply perform the function defined – namely, clear the tare, print the data, or take an automatic tare, and the next step in the sequence will appear.

**Note:** The **Print** function behaves in exactly the same way as pressing the Print key on the front of the terminal: A **Demand Output** must be configured, with **Scale** as the trigger and an appropriately structured template assigned to capture the data gathered by the ID sequence. For the names of the Shared Data variables used to store **Selection List** outputs, please refer to the **IND570 Shared Data Reference**.



If the input is set to **Selection List**, then instead of an open entry field, the operator will be presented with a drop-down list of up to six items, such as the names of types of containers or of products. In this case, the **Prompt** field will consist of an instruction to the operator to make a selection from the list. The **# of Selections** option simply defines how many options will appear in the list. If **Clear Data** is set to **Disabled**, then the selection made here will reappear the next time the sequence is run, so that if the operator is satisfied with the selection, it is only necessary to press ENTER to move the to the next step.

At the bottom of the third page of settings for **Selection List**, press the Edit softkey  to open the ID Selection List Edit screen. This screen will contain the number of fields specified by the **# of Selections** value. Enter the options that will be presented to the operator, up to a maximum of 30 characters, then click the BACK softkey to return to the ID editing screen.

**Note:** Only **one** selection list can be defined for each ID.

#### 4.4.2.3. Setting up the Softkey/s

The operator must be able to access the ID sequence or sequences, so the softkey for each configured ID must be added to the IND570s home screen:

In setup, access **Terminal > Softkeys**. Decide where the ID softkeys should appear – bearing in mind that the Information **Recall**  and **Setup**  softkeys must always be present. If they currently occupy places that will be used for the ID softkeys, either use the **NEW** softkey  to add the ID and push the other softkeys one space to the right, or select a new location, add the softkey/s, and then delete the originals.

To add an ID softkey, select the location and either select **EDIT** (if a softkey already occupies that spot and it is to be replaced by the ID softkey) or **NEW** (to shift all existing softkeys one space to the right).

From the drop-down list in the **SOFTKEY EDIT** screen, select the appropriate softkey – **ID1**, **ID2**, **ID3** or **ID4** – then click **BACK** and either add further softkeys, or click **BACK** to return to the setup menu tree.

#### 4.4.3. Operational Sequence Example

Now that an ID sequence is configured and the corresponding softkey has been assigned to the home screen, an operator can run it. The following simple configuration includes eight steps of a



possible 25, and is intended to show how this feature might be used to guide an operator through a series of actions. Here, the mode is **Soffkey**, and **Looping** is enabled.

- Note: The ID sequence can be abandoned at any point by pressing the EXIT/BACK soffkey .

Step	Configuration of ID Step	Operator Action	Notes
		Presses ID/n soffkey	
1	Entry: Alphanumeric Prompt: <b>Enter your name or user ID</b> Length: 30 Clear Data: Disabled	Enters name or other identifier, up to 30 characters long, pressed ENTER to move to next step.	Because <b>Clear Data</b> is Disabled, the name will appear in the input field the next time the sequence is run.
2	Entry: Selection List Prompt: <b>Select the material</b> List items: Material A Material B Material C	Uses the arrow keys to select the desired value, then presses ENTER again to confirm the selection and move to the next step.	The terminal saves the selection as part of the data it will associate with this transaction when it sends the information to the printer in step 7.
3	Entry: Numeric Prompt: <b>Enter the container serial #</b> Length: 8 Clear Data: Enabled	Enters the identification number of the container in use, up to 8 characters long, then presses ENTER to move to the next step.	Because <b>Clear Data</b> is Enabled, this field will be reset the next time the sequence is run, since in this case the same container will not be re-used.
4	Entry: Alphanumeric Prompt: <b>Place container on the scale</b> Length: 0	Places the container on the scale and presses ENTER to move to the next step.	The terminal displays the prompt, and waits for the operator to press ENTER. Because <b>Length</b> is set to 0, no input is solicited from the operator.
5	Entry: Tare – Auto	This step requires no operator intervention – having taken the tare, the terminal moves automatically to the next step.	The terminal takes an automatic tare, and sets its Net value to zero.
6	Entry: Alphanumeric Prompt: <b>Fill container to marked level</b> Length: 0	The operator fills the container on the scale to the level indicated. Once this process is complete, the operator presses ENTER to indicate to the terminal that it should move to the next step.	Because <b>Length</b> is set to 0, no input is solicited from the operator.

Step	Configuration of ID Step	Operator Action	Notes
7	Entry: Print	No intervention from the operator is necessary.	The terminal sends the data collected so far – the operator's name, the serial number of container, the material identifier, the tare value and the net weight from the previous step, as an output, to a printer or to a database.
8	Entry: Alphanumeric Prompt: <b>Move filled to the conveyor</b> Length: 0	Removes the container from the scale and places it on the outgoing conveyor belt, then pressed ENTER to confirm the action.	
9	Entry: Alphanumeric Prompt: <b>Enter your name or user ID</b> Length: 30 Clear Data: Disabled	Because <b>Looping is Enabled</b> , the sequence restarts automatically. Since the operator entered a name or identifier in the first sequence, and <b>Clear Data is Disabled</b> , it is only necessary to press ENTER to continue with the sequence under the same name. Or, if the operator has changed, a new name or ID can be entered. Alternatively, to exit the ID sequence, press the EXIT/BACK softkey  .	
10	[sequence continues from step 2]		

## 4.5. Information Recall

### 4.5.1. Overview





The IND570 offers users a great deal of information about the terminal's status and configuration, all of which can be accessed from the main screen by pressing the Information Recall softkey , one of two softkeys that are always present in one of the softkey rows. When this softkey is pressed, the RECALL screen appears.



Figure 4-4: RECALL Screen

This screen provides access to four types of information:

-  Weight Recall
-  System Information Recall
-  Metrology Recall
-  Service Information Recall

Each of these provides terminal information, as detailed in the following sections.

### 4.5.2. Information Recall Screens

#### 4.5.2.1. Weight Recall

The Weight Recall screen displays the current Gross, Tare and Net weight readings for the scale.



Figure 4-5: Weight Recall Screen

#### 4.5.2.2. System Information Recall



The System Information Recall screen provides basic information about the configuration of the terminal, including:

- Terminal serial number
- Terminal ID, as configured in setup at **Terminal > Device**
- Serial number of attached scale base
- Revision levels of installed firmware and software
- List of installed options

This information appears on more than one screen, and each new screen can be viewed by pressing the DOWN arrow.



**Figure 4-6: System Information Recall Screens**

In addition to the BACK key, two softkeys appear on the System Information Recall Screens – Print  and Connected Devices .

##### 4.5.2.2.1. Print – System Information Recall

Press the print key on this screen to send a report to a printer, via a connection with a Reports assignment. The report essentially reproduces the on-screen view, and will contain:

- Model
- Terminal ID fields 1 to 3
- List of hardware
- Serial Number
- List of installed software and revision levels

##### 4.5.2.2.2. Connected Devices

Press the Connected Devices softkey to view a list of peripheral devices connected to the terminal, including each device's description, model number and an associated note. The note may include information about the device such as its location or its function.



**Figure 4-7: Connected Devices**

4.5.2.2.3. Print – Connected Devices

Press the print key to send a Connected Devices report to a printer, via a connection with a Reports assignment.

**4.5.2.3. Metrology Recall **

The Metrology Recall screen displays the terminals’ metrology status. If the terminal is locked (in legal-for-trade mode), then the Metrology Control Number (MCN) is displayed. The terminal’s current software version and the date of its most recent calibration are also displayed. In the High-Precision IDNet version of the IND570, this information also includes the calibration tracking Ident Code of the attached scale base.





**Figure 4-8: Metrology Recall**

**4.5.2.4. Service Information Recall **

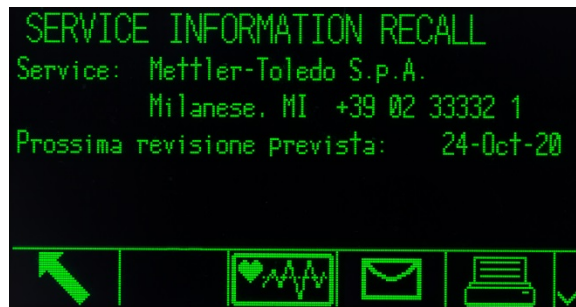
When the Service Information Recall softkey is pressed, the terminal displays local service contact information.



**Figure 4-9: Service Information Screen**

This screen also includes three additional softkeys – Terminal Status Report , User Observations  and Print .

#### 4.5.2.4.1. Terminal Status Report

The data displayed here is updated when the softkey is pressed, so it is always current. Multiple screens of information can be viewed by pressing the DOWN arrow.

The types of information visible here are indicated in Figure 4-10, and include battery status, details about weighing activity, and space remaining on the internal flash memory.

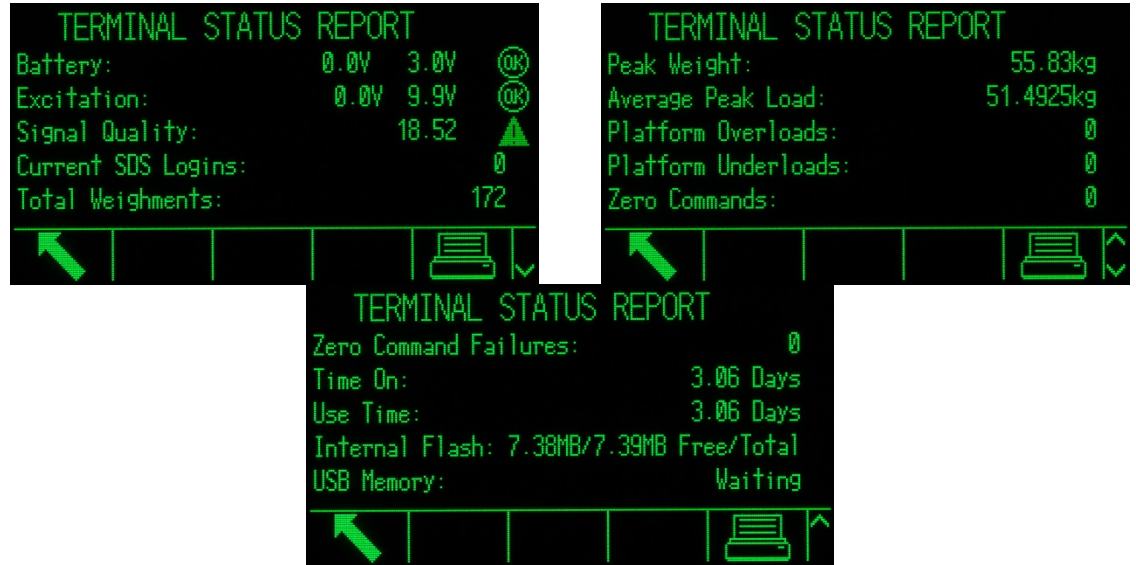

**Figure 4-10: Terminal Status Report**

Press the Print softkey to send this information to a printer, via a connection with a Reports assignment.

In the POWERCELL version, the Terminal Status Report includes two additional icons – LOAD CELL DETAIL (at center, in position three) and RESET (in softkey position four).



**Figure 4-11: Terminal Status Screen with Load Cell and Reset Icons**

Press the LOAD CELL DETAIL softkey to display a selection screen where a specific load cell can be selected.

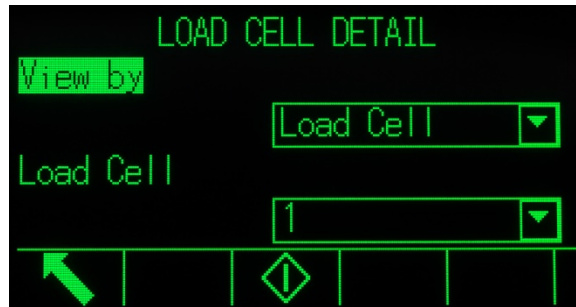

**Figure 4-12: POWERCELL Load Cell Detail Selection Screen**

Press the START softkey to read detailed information from the selected load cell.

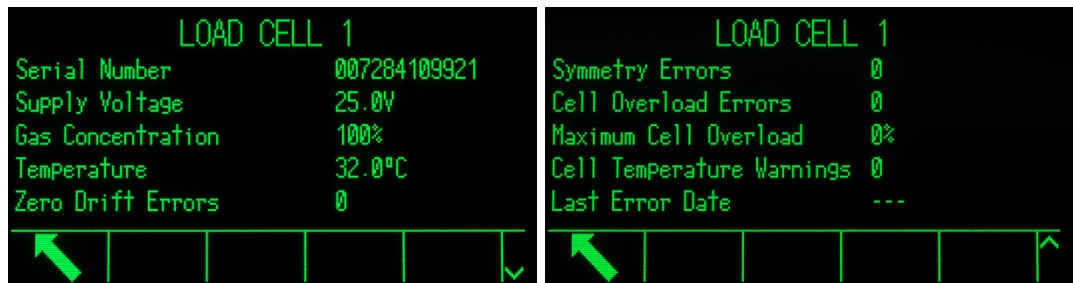

**Figure 4-13: Load Cell Detail Display**

Press the RESET softkey to update the displayed information. When RESET is pressed, OK appears beside nominal values, as seen in Figure 4-14. The **Use Time** and various weight values are reset to zero by the RESET softkey.





**Figure 4-14: Terminal Status Report (POWERCELL), Refreshed**

#### 4.5.2.4.2. User Observations

The User Observations screen includes a text entry field into which a terminal user can enter comments about the terminal's performance or status. When the Send softkey  is pressed, the remarks are sent as part of a Service Information Report, to any email recipient configured in setup at **Communication > Network > Email > Recipients**.

## 4.6. Remote Terminal

### 4.6.1. Overview

A useful characteristic of the IND570 is that it can be configured to function as a remote display for another IND570, or for any METTLER TOLEDO terminal capable of transmitting METTLER TOLEDO Continuous Output. In this case, the other terminal is referred to as the Primary.

If the Primary terminal is able to accept CPTZ command inputs, the function keys on the HMI of the remote IND570 can be used to issue simple commands to the Primary terminal.

### 4.6.2. Configuration Utilizing Serial Communication

Remote terminal configuration using serial communication involves three distinct setup processes:



- Physical connection between terminals
- Configuration of the Remote terminal
- Configuration of the Primary terminal

**4.6.2.1. Physical Connection Between Terminals**

Primary/Remote communication via serial uses a single serial connection. Since the IND570s serial ports can handle one output and one input simultaneously, only one port is required to connect to a Primary terminal. Any of the IND570's serial ports can be used, as they all support the three assignments used here:

- Remote Display
- Continuous Output
- CPTZ

RS-232, RS-422 or RS-485 serial protocols can be used, but the protocol selection must be the same in the Remote and Primary terminals.

**4.6.2.2. Configuration of the Remote Terminal**

A typical Primary/Remote setup via serial is shown in Figure 4-15.

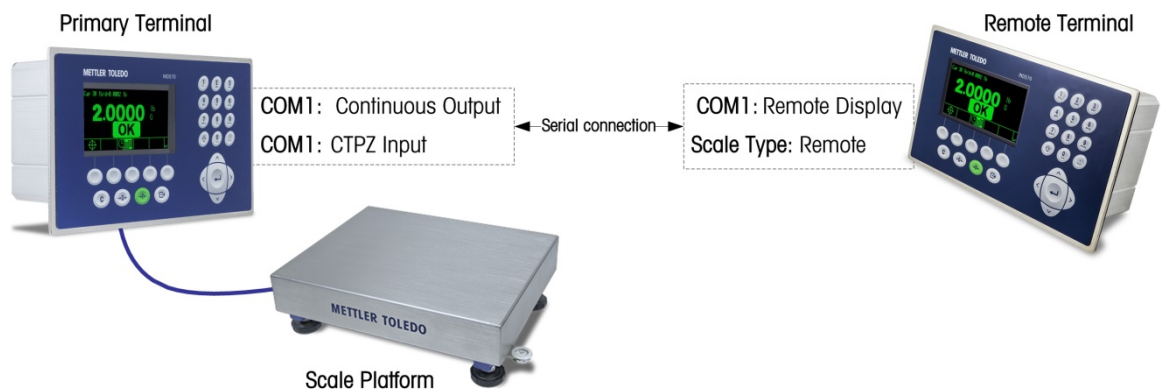

**Figure 4-15: Example of Terminal Configuration for Remote Display Function via Serial**

In setup, the following items must be correctly configured in order to support the use of a remote terminal:

In Setup	Required Settings
Scale > Scale Type	Set the <b>Scale Type</b> to <b>Remote</b> .
Communication > Connections	Create a connection on the desired port with an <b>Assignment of Remote Display</b> .
Communication > Serial > COM/n	Set the <b>Interface</b> parameters so that they correspond with the settings of the connection port in the Primary terminal.

**4.6.2.3. Configuration of the Primary Terminal**

In setting up the Primary terminal, similar settings must be made in order to communicate with the Remote terminal:

In Setup	Required Settings
Communication > Connections	Create a connection on the desired port with an <b>Assignment of Continuous Output</b> .
	To be able to receive simple C, T, P, Z commands from the Remote terminal, the port selected for communication must have a secondary assignment of <b>CTPZ Input</b> .
Communication > Serial > COM/n	Set the <b>Interface</b> parameters so that they correspond with the settings of the connected port in the Remote terminal.

### 4.6.3. Configuration Utilizing Ethernet Communication

Remote terminal configuration using Ethernet involves three distinct setup processes:

- Physical connection between terminals
- Configuration of the Remote terminal
- Configuration of the Primary terminal

#### 4.6.3.1. Physical Connection Between Terminals

Primary/Remote communication via Ethernet uses the Print Client and EPrint connections. A typical Primary/Remote setup is shown in Figure 4-16.

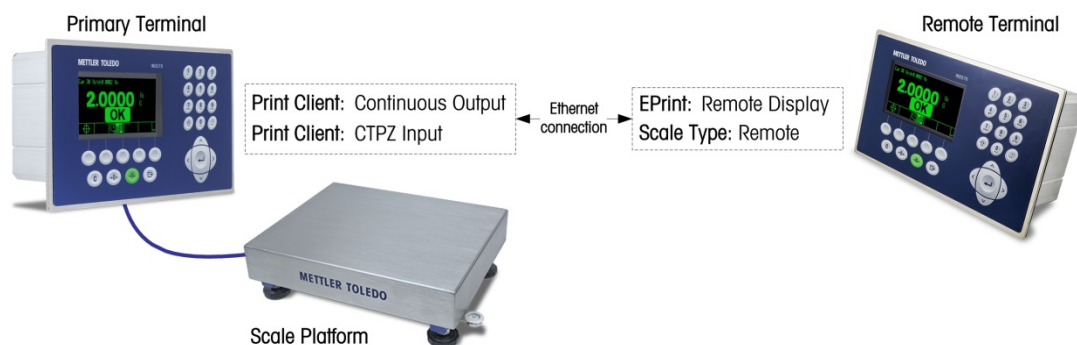

Figure 4-16: Example of Terminal Configuration for Remote Display Function via Ethernet

#### 4.6.3.2. Configuration of the Remote Terminal

In the Remote terminal's setup menu, the following items must be configured correctly to allow communication with the Primary terminal:

In Setup	Required Settings
Scale > Scale Type	Set the <b>Scale Type</b> to <b>Remote</b> .
Communication > Connections	A connection must be created on the Eprint port with its <b>Assignment</b> set to <b>Remote Display</b> .
Communication > Network > Ethernet	Set the <b>IP Address</b> , <b>Subnet Mask</b> and <b>Gateway Address</b> manually, or enable DHCP for automatic addressing.
Communication > Network > Secondary Port	Set the <b>Secondary Port #</b> parameter so that it differs from the Primary Port # parameter, for example 1702.

#### 4.6.3.3. Configuration of the Primary Terminal

In the Primary terminal's setup menu, the following items must be correctly configured to allow communication with the Remote terminal:

In Setup	Required Settings
Communication > Connections	A connection must be created on the Print Client port with its <b>Assignment</b> set to <b>Continuous Output</b> .
	To be able to receive simple C, T, P, Z commands from the Remote terminal, create a second connection on the Print Client port with its <b>Assignment</b> set to <b>CTPZ Input</b> .
Communication > Network > Print Client	Set the <b>Server IP Address</b> parameter so it corresponds to the IP Address of the remote device.
Communication > Network > Print Client	Set the <b>Server TCP</b> parameter so that it corresponds to the listening port of the remote device.

#### 4.6.4. Configuration Using WiFi Communication

Remote terminal configuration using WiFi involves four distinct setup processes:

- Physical connection of the Primary terminal to a network
  - Connection of Remote terminal to a network access point
  - Configuration of the Remote terminal
  - Configuration of the Primary terminal
- When using the WiFi port for remote display operation, the remote terminal must be configured first, and then the primary terminal can be configured. If the remote terminal is not configured first, erratic behavior (such as taring and zeroing) may occur on the primary terminal.

##### 4.6.4.1. Connection Between Terminals

Primary/Remote communication via WiFi uses the Print Client and WiFi connections. A typical Primary/Remote setup is shown below.

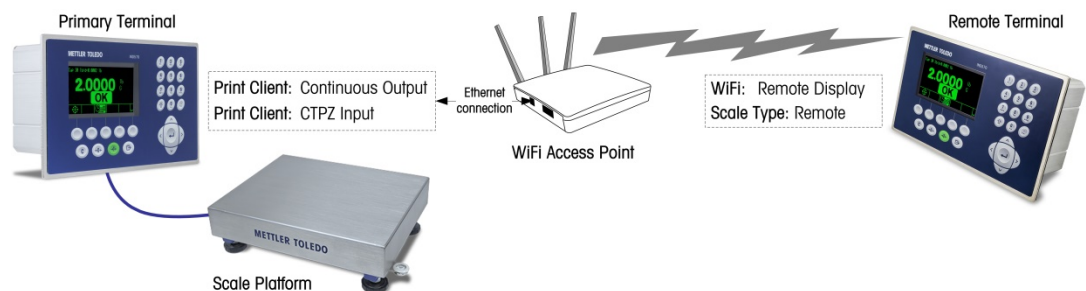

Figure 4-17: Example of Terminal Configuration for Remote Display Function via WiFi

##### 4.6.4.2. Remote Terminal Configuration

Note that only the Remote terminal is supported with a WiFi connection. The Primary terminal must be wired into the network. In the Remote terminal's setup menu, the following items must be configured correctly to allow communication with the Primary terminal:

In Setup	Required Settings
Scale > Scale Type	Set the <b>Scale Type</b> to <b>Remote</b> .
Communication > Connections	A connection must be created on the WiFi port with its <b>Assignment</b> set to <b>Remote Display</b> .
Communication > Network > WiFi Module	Set the SSID, Password, <b>IP Address</b> , <b>Subnet Mask</b> and <b>Gateway Address</b> manually, or enable DHCP for automatic addressing.
Communication > Network > WiFi Port	Set the <b>WiFi Port #</b> parameter, for example 1702.

#### 4.6.4.3. Configuration of the Primary Terminal

Note that the Primary terminal must be wired into a network – WiFi connection is not supported for the Primary terminal. In the Primary terminal’s setup menu, the following items must be configured correctly to allow communication with the Remote terminal:

In Setup	Required Settings
Communication > Connections	A connection must be created on the Print Client port with its <b>Assignment</b> set to <b>Continuous Output</b> .
	To be able to receive simple C, T, P, Z commands from the Remote terminal, create a second connection on the Print Client port with its <b>Assignment</b> set to <b>CTPZ Input</b> .
Communication > Network > Print Client	Set the <b>Server IP Address</b> parameter so it corresponds to the IP Address of the remote device.
Communication > Network > Print Client	Set the <b>Server TCP</b> parameter so that it corresponds to the listening port of the remote device.

#### 4.6.5. Operational Examples

With a Primary and Remote terminal setup configured as described, an operator can now observe the Primary terminal’s weight information on the Remote terminal’s screen.

Also, when the IND570 is paired with a primary terminal that supports CPTZ on the same Ethernet connection, the operator can use the Remote terminal’s front panel buttons to issue a Clear command to remove a tare value; a Tare command to take a tare; issue a print command; and zero the scale (provided the current weight value is close enough to calibrated zero to make this possible). Two common use-cases are outlined in the following sections.

##### 4.6.5.1. Truck Scales

In vehicle weighing, it is possible that a primary terminal in a kiosk may be used by truck drivers to initiate weighing transactions, with a remote terminal available in the scale house, mirroring the kiosk terminal so that an attendant can also observe scale weights and interact with the primary.

##### 4.6.5.2. Hazardous Area

When weight data and control are needed both within and outside a hazardous area, the IND570 provides an economical solution, so that a more costly hazardous-area primary terminal is required only for the hazardous area, with the remote terminal installed in the safe area and available for operator viewing and interaction, PLC interface, etc.

## 4.7. Simple Filling

### 4.7.1. Overview

The IND570 can be used to perform simple filling tasks; more sophisticated filling and dosing capabilities are available when the optional Fill-570 software is installed, but the terminal's native capabilities are sufficient for basic filling applications.

### 4.7.2. Configuration

The system setup menus include a number of settings that can be modified in order to optimize the terminal for filling.

#### 4.7.2.1. Scale > Vibration

For IDNet scale bases only, the settings at **Scale > Vibration** can be modified to account for the conditions in which filling will take place. The settings made here, in **Vibration** and **Weighing Process**, affect how the terminal reacts to changes in ambient conditions. Typically, selecting settings in these setup areas involves a trade-off between scale sensitivity and speed of response.

#### 4.7.2.2. Application > Memory > Target Table

Simple filling requires a target for the terminal to fill to. The Target Table allows the definition of a set of target parameters, which can be recalled from the home screen. Each target record includes the following settings.

##### 4.7.2.2.1. Mode

For simple filling, the **Mode** must be set to **Material Transfer**.

##### 4.7.2.2.2. Tolerance Type

When Material Transfer mode is selected, the terminal offers two types of tolerance – **Target Deviation** and **% of Target**.

**Target Deviation** is measured as an absolute weight value, in the same units as the target value itself. For example, if a target of 100 kg is selected, positive and negative deviations of 5 and 2 kg, respectively, might be defined in the target record, and (unless they are changed) these values will remain fixed regardless of any change to the target value.

**% of Target** is measured as a relative value, expressed as a percentage of the target value. In this case, if the target is 100 kg, and the positive and negative tolerances are 5% and 2%, the tolerance band will remain proportionate to the target value, if that is changed. Thus, if the record is modified with a new target of 200 kg, the positive and negative tolerances will remain 5% and 2%, and represent 10 kg and 4 kg respectively.

##### 4.7.2.2.3. Output Type

This parameter is only available in Material Transfer mode. In a two-speed system (for instance, fast feed/fine feed), it determines the relationship between outputs (as in, signals controlling external equipment such as valves and agitators).



A **Concurrent** output type means that both outputs operate at the same time – so during fast feed, the fine feed output is/can be also activated.



An **Independent** output type separates the two outputs – when fast feed ends, the fast feed output turns off and the fine feed output turns on.

#### 4.7.2.2.4. Totalization

For record-keeping purposes, the terminal can sum the displayed weights of feeds associated with each target record. Thus, if ten filling transactions are performed using a record with a 100 kg target, the target record would reflect approximately 1,000 kg of material.

#### 4.7.2.2.5. Target Edit

Once the general parameters of the target have been defined, pressing the **Target Search** softkey , and then the **Search** softkey  will display the **Target Search View**, a list of all targets. (As with all table searches, the results can be filtered using the operators on the Target Search screen.)

In the Target Search View, either press the **New** softkey  to create a new record based on the configured parameters, or use the arrow keys to select a record to be **Edited**  or **Deleted** .

The **Target Edit** screen allows the following parameters to be set.

##### **ID**

The ID is the record's serial number identifier. It must be unique – to replace an existing record with a particular ID number, it must first be deleted, then a new record created with that number entered in the ID field.

##### **Target**

The target value and its units are defined here. The target record units and the comparison units can be a combination of primary, second or third units.

##### **Tolerance**

Depending on the type of tolerance selected in the Target Table setup screen, the two tolerance fields, - and +, will accept an entry of an absolute weight value, or of a percentage to be applied to the target value.

##### **Spill**

Spill is a measure of the amount of material that will be delivered after the feed is cut off. It is empirically determined, and entered here as an absolute weight value. This material must be accounted for in configuring a target, or the result of a filling operation will be consistently above target.

##### **Fine Feed**

In two-speed filling operations, the **Fine Feed** value determines when the **Fast Feed** output is turned off in order to bring the operation to a 'soft stop' and avoid over-running the target. Again, this value is based on empirical observation of the behavior of the filling system, but it should be small enough to enable the rapid completion of the fill, but not so small that the fast feed stops too late and over-runs the target.

### Description

This field allows each target record to have a descriptive identifier. This can be a useful aid when selecting from a list that includes multiple targets, and may note the material involved or the type of vessel into which the feed will be made.

#### 4.7.2.3. Application > Operation > Target

Once the target record configured, the terminal must be instructed how to use it. Two parameters must be set here – the **Source** of the weight that the terminal will read during the feed operation, and the **Latching** mode, or the way in which the outputs controlling the material transfer mechanism behave once the target is reached. When **Latching** is **Enabled**, the output feeds will remain off (or latched) once they are turned off when the target is reached, and will remain off until a start command is issued, either by the **Target Start** or **Target Control** softkeys, or by a discrete input.

#### 4.7.2.4. Terminal > Display

SmartTrac is a graphical feature of the IND570 display that allows the operator to observe the progress of a feed. SmartTrac provides an intuitive representation of the relationship between the weight on the scale and both the designated target and the permissible tolerance band (above and below the target).

In the **Display** screen, the **Auxiliary Display** parameter sets the type of SmartTrac display that will appear when a fill is being performed. SmartTrac can be viewed as Small, Medium or Large. The information available from each of these sizes varies, so it is possible to select the one which most closely matches the requirement of the filling operation in question.

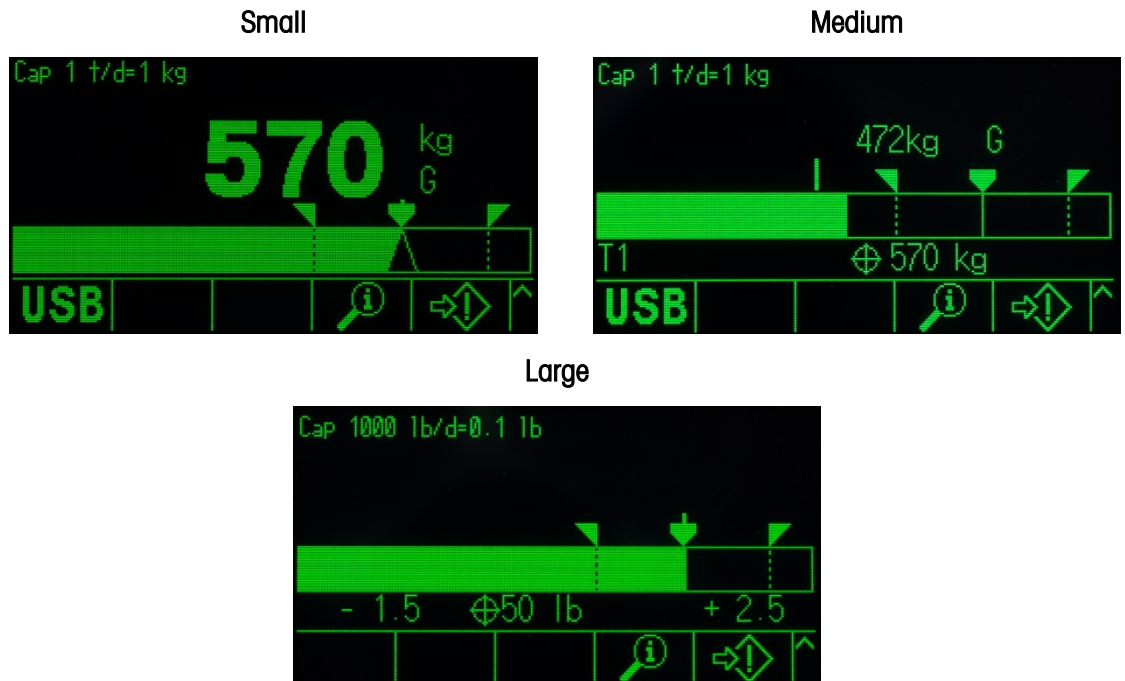





Figure 4-18: SmartTrac Display Sizes in Material Transfer Mode

For example, as Figure 4-18 shows, only the **Large** size displays the high and low tolerance values, while the **Small** size only displays the current scale weight and the bar graph.

#### 4.7.2.5. Terminal > Softkeys

The terminal offers a selection of softkeys which are useful for simple filling activities.

The operator must be able to select a target and to start the filling process so, at a minimum, the **Target**  or the **Target Table**  softkey must be assigned, as well as either the **Target Start**  or **Target Control**  softkey. Refer to section 4.7.3, the **Operational Sequence Example**, to see how these softkeys function.

#### 4.7.2.6. Communication > Discrete I/O > Inputs

In some circumstances, it is necessary to perform filling tasks without pressing buttons on the terminal's front panel. This is achieved by configuring discrete inputs which correspond to the **SmartTrac**, **Target Start/Resume** and **Target Pause/Abort** softkeys, so that remote interface devices, such as large buttons, control filling. Of course, the terminal must have one of its DI/O option boards installed for this to be possible. Then it is simply a matter of mapping the remote input device to the address for the corresponding input. For instance, Target Start/Resume might be mapped to input address 0.1.1, and Target Pause/Abort to input address 0.1.2.

### 4.7.3. Operational Sequence Examples







#### 4.7.3.1. Automatic Filling

When the terminal is performing filling operations automatically, the operator's main interaction with the process is to issue the start command for each fill. Essentially, this merely confirms that the correct vessel is on the scale and starts the terminal on its fill sequence. Once the fill is complete, the terminal waits to be instructed to start again, after the filled vessel has been removed and a new one placed on the scale.

##### 4.7.3.1.1. Typical Automatic Filling Sequence

In automatic filling, the terminal controls the addition of material to the vessel on the scale, so for the most part the operator merely observes the process, ready to intervene if an error should occur.

The typical filling sequence that follows assumes that a target has been selected, and that a vessel is on the scale, the scale is tared, and the terminal is in net mode.

1. Press the **Target Control** softkey . The Target Control screen will appear, with **Back**  and **Target Start**  softkeys displayed, and a status message reading **Ready**.
2. After checking that the right vessel is on the scale, press .
3. The terminal starts the filling process. The Target Control screen now shows a status message, **Running**, and a **Pause** softkey  in place of **Target Start**. It also adds a **Stop/Abort** softkey  in the fifth position. Press one of these to pause or abandon the filling process. When **Pause** is pressed, the **Start** softkey reappears, functioning as a **Resume** button. **Stop/Abort** exits the **Target Control** screen and returns to the view to the terminal's home screen. Press the **Back** softkey to display SmartTrac.



4. Once filling is complete – the scale weight is within the tolerance zone – the terminal waits for the scale weight to fall below the latching threshold, indicating that the filled vessel has been removed from the scale. The terminal is now ready to begin the next filling operation, as soon as the **Start** command is issued.

#### 4.7.3.2. Manual Filling

In manual filling, when an operator is adding material to a vessel on a scale, the SmartTrac display and the control softkeys are much more important. The display has a number of tools to assist the operator in filling to target, and within the tolerance band.

##### 4.7.3.2.1. SmartTrac Assistance for Operators

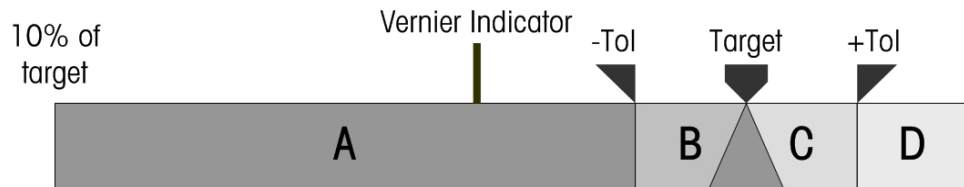

**Figure 4-19: Elements of the SmartTrac Graph**







The main feature of the SmartTrac display is its bar graph, and this includes several features, indicated in Figure 4-19 and explained in Table 4-3.

**Table 4-3: Elements of SmartTrac Explained**

<b>10% of target</b>	The bar graph begins to register the scale weight when it reaches 10% of the configured target value. Until this weight is reached, the bar graph is empty.
<b>A</b>	A represents weight values between 10% of the target and the negative tolerance (-Tol) value. As weight is added to the scale, the bar moves from left to right in this zone at a rate corresponding to the speed at which weight is being added. When the bar graph enters the tolerance zone (B), it becomes more sensitive to changes. In other words, for each additional unit of weight the graph moves further when in the tolerance zone than it did in zone A.
<b>Vernier Indicator</b>	The Vernier indicator, meanwhile, moves at rate with a constant relationship to the rate of change of weight on the scale. It adds detail to the bar graph's movement during the filling operation so that the operator can respond more appropriately as the scale weight approaches its target.  While the bar graph becomes more sensitive to change when it is in the tolerance zone, the Vernier keeps its proportional relationship to the scale weight, which makes it easier for the operator adding material to avoid over-running the target.
<b>-Tol, B, Target, C, + Tol</b>	Zones B and C, between -Tol and +Tol, indicates the range of weights within an acceptable distance from the target. Symbols for each of the cut-off points appear above the graph, and when the scale weight exactly corresponds to the target weight, a triangle is displayed straddling the target line.
<b>D</b>	D is the over-fill zone. If the bar graph has reached this zone, the operator will need to remove material from the scale until the weight is reduced sufficiently to fall within the acceptable tolerance zone.

##### 4.7.3.2.2. Typical Manual Filling Sequence

This sequence assumes that the operator has access to the appropriate target table and target control softkeys.

1. If SmartTrac is not displayed, press the **SmartTrac** softkey  to show it.
2. Select a target value – either by direct entry, pressing the **Target** softkey  and entering the desired values for **Target**, **Spill**, **Fine Feed**, **Tolerance** and **Description**; or by pressing the **Target Table** softkey , displaying the **Target Search View**, and selecting a target record to use.
3. With the vessel to be filled on the scale, press the **Tare** key  to zero the scale and enter Net mode.
4. Start the filling process by pressing **Target Start** , or **Target Control** . The difference between these two options is as follows:
  - a. **Target Start** shows the SmartTrac display.
  - b. **Target Control** shows a status screen, from which SmartTrac is accessed by pressing the **Back** softkey .

The **Target Control** softkey is more typically used for automatic filling procedures. In manual filling it is critical to be able to observe the SmartTrac display.
5. Begin filling, by whatever method is defined for the procedure. This can involve using a scoop to add material, or by operating a lever to open a valve, or by using the controls of a separate piece of filling equipment.
6. Observe the SmartTrac display and its Vernier indicator. Manage the filling process so that the bar graph approaches the target at a controlled rate, and filling can be stopped within the acceptable tolerance.
7. When an acceptable fill has been achieved, remove the vessel from the scale and add a new one, so that the sequence can start again.

# 5 Service and Maintenance

This chapter covers

- Cleaning and General Maintenance
- Service
- Screen Saver
- System Backup and Restore
- Back and Restore Using InSite
- Upgrading Firmware
- Error Management
- Diagnostic Information
- Problem Diagnosis and Troubleshooting
- Web Server
- Master Reset
- InTouch
- Proactive Alarming and Alerting









The IND570 terminal is designed to provide years of dependable operation. However, METTLER TOLEDO recommends that – as with any industrial equipment – the IND570 terminal and the connected scale system be serviced periodically. Timely, factory-specified maintenance and calibration by a METTLER TOLEDO service technician will ensure and document accurate and dependable performance to specifications.

## 5.1. Cleaning and General Maintenance

Clean the IND570 terminal's keypad and cover with a clean, soft cloth that has been dampened with a mild glass cleaner. Do not use any type of industrial solvent such as toluene or isopropanol (IPA) that could damage the terminal's finish. Do not spray cleaner directly on the terminal.



The IND570 is a rugged stainless steel enclosed instrument; however, the front panel is a relatively thin covering over sensitive electronic switches and a lighted display. Care should be taken to avoid any punctures to this surface or vibrations or shocks to the instrument. If the front panel is punctured, immediately take appropriate steps to prevent dust and moisture from entering the unit until the terminal can be repaired.

	<b>WARNING</b>
	<b>ONLY PERMIT QUALIFIED PERSONNEL TO SERVICE THE TERMINAL. EXERCISE CARE WHEN MAKING CHECKS, TESTS AND ADJUSTMENTS THAT MUST BE MADE WITH POWER ON. FAILING TO OBSERVE THESE PRECAUTIONS CAN RESULT IN BODILY HARM AND/OR PROPERTY DAMAGE.</b>



	 <b>WARNING</b>
	<b>IF THE KEYBOARD, DISPLAY LENS OR ENCLOSURE IS DAMAGED ON A DIVISION 2-OR ZONE 2/22 APPROVED IND570xx TERMINAL THAT IS USED IN A DIVISION 2 OR ZONE 2/22 AREA, THE DEFECTIVE COMPONENT MUST BE REPAIRED IMMEDIATELY. REMOVE POWER IMMEDIATELY AND DO NOT REAPPLY POWER UNTIL THE DISPLAY LENS, KEYBOARD OR ENCLOSURE HAS BEEN REPLACED BY QUALIFIED SERVICE PERSONNEL. FAILURE TO DO SO COULD RESULT IN BODILY HARM AND/OR PROPERTY DAMAGE.</b>
	 <b>WARNING</b>
	<b>FOR IND570xx, KEEP THE TERMINAL AWAY FROM PROCESSES THAT GENERATE HIGH CHARGING POTENTIAL SUCH AS ELECTROSTATIC COATING, RAPID TRANSFER OF NON-CONDUCTIVE MATERIALS, RAPID AIR JETS, AND HIGH PRESSURE AEROSOLS.</b>
	 <b>WARNING</b>
	<b>FOR IND570xx, AVOID ELECTROSTATIC CHARGING DURING OPERATION AND MAINTENANCE.</b>
	 <b>WARNING</b>
	<b>FOR IND570xx, DO NOT USE DRY CLOTH TO CLEAN THE WEIGHING TERMINAL. ALWAYS USE A DAMP CLOTH TO CLEAN THE TERMINAL GENTLY.</b>

## 5.2. Service

Only qualified personnel should perform installation, programming, and service to the IND570. Please contact a local METTLER TOLEDO representative for assistance.

- Contact information for your local service provider may be available in the terminal. Press the INFORMATION RECALL  softkey and then the SERVICE ICON softkey  to view any available service contact information.

METTLER TOLEDO recommends periodic preventative maintenance to the terminal and scale system to ensure reliability and to maximize service life. All measurement systems should be periodically calibrated and certified as required to meet production, industry and regulatory requirements. We can help you maintain uptime, compliance and quality system documentation with periodic maintenance and calibration services. Contact your local METTLER TOLEDO authorized service organization to discuss your requirements.

	 <b>WARNING</b>
	<b>DO NOT INSTALL, DISCONNECT OR PERFORM ANY SERVICE ON THIS EQUIPMENT BEFORE POWER HAS BEEN SWITCHED OFF AND THE AREA HAS BEEN SECURED AS NON-HAZARDOUS BY PERSONNEL AUTHORIZED TO DO SO BY THE RESPONSIBLE PERSON ON-SITE.</b>

### 5.2.1. Enclosure Gasket

For the harsh environment model, in order to preserve the enclosure's IP rating, inspect the sealing gasket to ensure that it makes a good seal, and does not have permanent indentations.

Gasket lifetime is shortened by exposure to high temperatures. The enclosure gasket should be inspected during any maintenance activity, and replaced if it becomes damaged or brittle.

## 5.3. Screen Saver

METTLER TOLEDO recommends the use of the automatic screen saver in order to maintain the clarity of the display. The IND570 screen saver can be enabled in setup at **Terminal > Display > Screensaver**.

In terminals with an LCD display, the display backlight is adjustable, and can be configured to turn off after a period of terminal inactivity. The Backlight Timeout is defined in minutes, in setup at **Terminal > Display > Backlight Timeout**.

## 5.4. System Backup and Restore

The standard USB port supports backup of certain terminal data to a USB flash drive. Data available for backup includes:

- Configuration (includes tables and log files)
- Calibration
- TaskExpert (program files and bitmaps)
- Templates

	<b>WARNING</b> THE USB INTERFACE IS NOT CERTIFIED FOR USE IN DIVISION 2 OR ZONE 2/22 HAZARDOUS AREAS. USE ONLY IN SAFE AREA.
---	--

The data can later be restored to the terminal via the USB port, or copied to additional terminals in a replication or cloning process. This facilitates the quick restoration of setup should a main PCB require replacement, for example. It also allows for the easy creation of functionally identical terminals.

### 5.4.1. Backup and Restore File Structure

When a backup to USB is performed, the IND570 automatically creates a file structure on the root directory of the USB device. The top level filename is "IND570". Within the IND570 folder are individual folders for each terminal's data set. The serial number of the terminal is used as the filename of the backed up data. Figure 5-1 shows the file structure created by the IND570 during a backup.

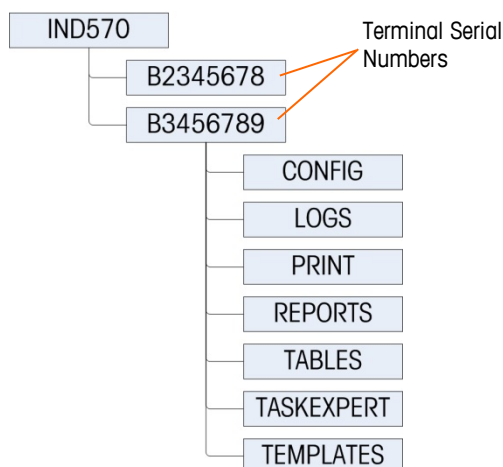

**Figure 5-1: USB Backup File Structure**

**5.4.1.1. File Locations on USB Drive**

The software upgrade, backup and restore functions use the following folders on the USB drive.

**Table 5-1: USB Folders and File Names**

Location on USB Memory Device	Stored Files		
IND570\Terminal Serial #\Config	bkram.dmt CalTest1.txt CalTw1.txt e2prom1.dmt EccTest1.txt	EccTw1.txt flash.dmt intouch.xml RepTest1.txt RepTw1.txt	SensTest.txt SensTw1.txt tare.bin target.bin
IND570\Terminal Serial #\Logs	Alibi.csv Change.csv	ErrLog.csv GWPLog.csv	Maint.csv pwrcl_per.csv
IND570\Terminal Serial #\Print	If USB port is configured to receive a Demand Output (print), a .txt file with the name of the template being printed is created here to collect the data from those Demand Outputs. The maximum size of the template text file created and stored on a USB flash drive is limited to 5 MB, or the available free space on the USB flash drive, whichever is smaller.		
IND570\Terminal Serial #\Reports	If USB port is configured to receive a Reports print, the report text file (.txt) is saved in this folder		
IND570\Terminal Serial #\Tables	If tables A0-A10 contain data, the .csv files for those tables is saved here		
IND570\Terminal Serial #\TaskExpert	If TaskExpert program files (.cpt) and images (.bmp) are loaded into the terminal, those files are saved in this file		
IND570\Terminal Serial #\Templates	Template1.txt Template2.txt Template3.txt Template4.txt	Template5.txt Template6.txt Template7.txt	Template8.txt Template9.txt Template10.txt

When executing a restore from USB, each file must:

- Be placed in a top level folder that matches the serial number of the terminal to which the information is being uploaded.
- Be placed in the appropriate USB file folder and have the correct file name, so that the **Restore from USB** function can complete successfully. One of the easiest ways to ensure that correct file structure and file names are being used is to perform a **Backup to USB** immediately after installation, and again after making any changes to the terminal's configuration or tables. The correct file structure and filenames are created automatically, making it easier to recognize the appropriate filenames and locations on the USB memory device.

## 5.4.2. Backup to USB

Backup to USB can be performed by users with any access level, and may be carried out even when the terminal is metrologically sealed. When the Backup to USB function is executed, the IND570 creates a file structure on the USB memory device, using the terminal's serial number as the name of the top-level file folder. An example of this structure is shown in Figure 5-1.

### 5.4.2.1. To backup files to a USB memory device

1. Connect a USB (flash) memory device to the IND570 USB port.
  - USB memory devices are automatically recognized as such.
2. Press the SETUP softkey  $\leftarrow \diamond$ . Navigate to **Maintenance > Run > Backup to USB**. Press ENTER. The screen shown in Figure 5-2 will appear.

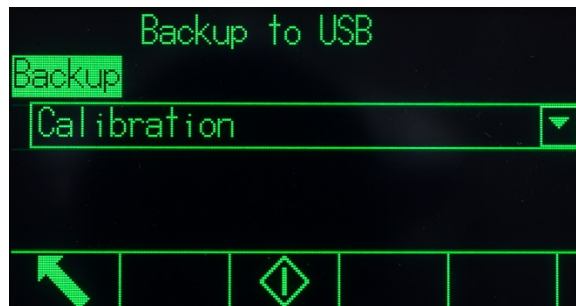



Figure 5-2: Backup to USB

3. Select the information to be backed up to the USB drive. Selections include:
  - Calibration** [default], Configuration, TaskExpert, Templates
4. Press the START  $\diamond$  softkey. The terminal will show "Working...Please Wait" as the backup attempt is made.
  - If no external USB drive is connected or recognized, the terminal will display a message "USB memory not present."
  - A successful backup will show "Backup Successful", and the operator will be prompted to press the ENTER key. A failed backup will show "Backup Failure". Press ENTER to acknowledge.

- If the USB memory device does not have enough memory to store the desired files, the message “Insufficient Memory Available” is shown. Press ENTER to acknowledge.

5. When the terminal indicates that the backup is complete, the USB device can be unplugged. Press the EXIT  softkey to return to the main menu.

### 5.4.3. Restore from USB

- System Restore cannot be performed if the terminal is metrologically sealed.
- Access to the USB port must be set as Read/Write in order to complete a Restore from USB.
- If user security is enabled, an Administrator level login must be in effect to carry out this procedure.
- A system restore operation does **not** copy log files (Alibi Memory, Maintenance Log, Change Log, POWERCELL Performance Log) from the saved dataset. The terminal’s existing log files are not over-written during a restore.

The system restore screen allows a dataset saved on a USB device to be restored or copied to a new terminal. Scale calibration parameters can be restored or not restored, depending on the selection from the drop-down list.

#### 5.4.3.1. To restore files from a USB memory device

1. Connect a USB (flash) memory device to the IND570 USB port.
2. Press the SETUP . Navigate to **Communication > Access/Security > USB > Memory Stick**. Set this field as Read/Write. Exit back to the to the main setup menu structure.
3. Navigate to **Maintenance > Run > Restore from USB**. Press ENTER. The screen shown in Figure 5-3 will appear.

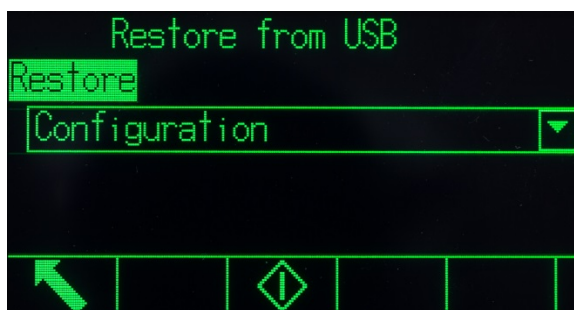



Figure 5-3: Restore from USB

4. Select the information to be restored from the USB drive. Selections include:
  - Calibration** [default], Configuration, TaskExpert, Templates
5. Press the START  softkey to initiate the transfer of files. The terminal will show “Working... Please wait” as the backup attempt is made.
  - If no external USB drive is connected or recognized, the message “No USB Memory Installed” is shown. Press ENTER. Wait one more minute and try again. The IND570 may still be busy reading the connected USB memory device.





- If a message "Access Denied. User Not Authorized" or "Authentication Failure" is shown, reading files from the USB port may not be enabled. Navigate to **Communication > Access/Security > USB > Memory Stick**. Confirm this field is set as **Read/Write**.
6. A successful restore backup will show "Restore Successful". A failed restore will show "Restore Failure". Press ENTER to acknowledge.
    - A failed restore could be the result of a missing or corrupted data file, an incorrectly named file, or an incorrect file structure under the terminal serial number.
  7. Once the terminal indicates that the backup is complete, the USB device can be unplugged and the EXIT  softkey pressed to return to the main menu.
  8. Upon exiting the main menu after a restore from USB, the IND570 will automatically restart to complete the restore process.

## 5.5. Backup and Restore Using InSite™ SL

InSite SL is an application for the PC that can be used to save the terminal configuration and restore it at a later date, or copy configurations into other terminals.

Procedures for importing and exporting files using InSite SL are provided in the **InSite SL User's Guide**. Both the InSite™ SL PC tool and the User's Guide are available for download from <http://mt.com>.

## 5.6. Upgrading Firmware

	 <b>WARNING</b>
	<b>ONLY PERMIT QUALIFIED PERSONNEL TO PERFORM FIRMWARE UPDATES ON THE TERMINAL. PLEASE CONTACT A LOCAL METTLER TOLEDO REPRESENTATIVE FOR ASSISTANCE.</b>

### 5.6.1. Recommended Backup Prior to Firmware Upgrade

Before loading a firmware upgrade to an IND570 terminal via any available method, it is highly recommended to run a complete backup of all terminal configuration, including calibration, templates and any custom TaskExpert files prior to executing the firmware upgrade.

### 5.6.2. IND570 Firmware Upgrade via USB

To perform a firmware upgrade via the USB port:

1. Create the following folder structure on the root directory of a USB memory device:  
**IND570 / upgrade**
2. Place the firmware file into the "upgrade" folder.
3. Rename the firmware file "**upgrade.dat**" for the analog, IDNet and SICSpro versions of the IND570 and "**upgrade\_pwrcl.dat**" for the POWERCELL version.
4. Connect the USB drive to its USB port.

5. Press the SETUP softkey. Navigate to **Maintenance > Run > Install Upgrade** and press ENTER.
6. At the **Install SW Upgrade** screen, when displayed status is "Ready", press the START softkey to initiate the upgrade. The IND570 will indicate that it is working.
7. When the upgrade is complete, the IND570 will display an "Upgrade Successful" pop up message. Press the ENTER key to acknowledge the message. This initiates a power cycle.
  - NOTE: A Master Reset is recommended after every change in firmware version. Ensure that terminal configuration and calibration is backed up to a USB memory device before performing a Master Reset. This data can be reloaded into the terminal after the Master Reset is complete.
  - NOTE: The Boot Loader or Boot Code file for an IND570 cannot be loaded to the terminal using the USB upgrade process.

	<b>WARNING</b>
<b>THE USB INTERFACE IS NOT CERTIFIED FOR USE IN DIVISION 2 OR ZONE 2/22 HAZARDOUS AREAS. USE ONLY IN SAFE AREA.</b>	

#### 5.6.2.1. Power Failure during Firmware Update via USB

In the event that power is lost during a firmware upgrade via USB, it might be necessary to load the IND570 firmware using InSite CSL.

As the IND570 executes the firmware upgrade via USB, the following stages are carried out:

1. The terminal copies the firmware from USB stick to RAM. This process takes about 20 seconds.
2. The terminal then writes the new firmware from RAM to Flash. This stage take approximately 10 seconds.
3. The IND570 will power cycle and the upgrade is a success.

If power is interrupted within 20 seconds of starting the upgrade (during the copy to RAM), the IND570 will simply revert to the original version of firmware present before the upgrade was attempted. If power is interrupted after approximately 20 seconds (during the write to Flash), the upgrade will fail. At this time, the only way to recover the terminal is to carry out a firmware upgrade using InSite™ CSL.

#### 5.6.3. SICSpro Platform Firmware Upgrade via IND570 USB

To perform a firmware upgrade for a SICSpro base using the IND570's USB port:

1. Create the following folder structure on the root directory of a USB memory device:  
**IND570/upgrade**
2. Place the firmware for the SICSpro base into the "upgrade" folder.
3. Rename the SICSpro firmware file "upgrade.mot"
4. Connect the USB drive to the IND570 USB port
5. Press the SETUP softkey. Navigate to **Maintenance > Run > Install Base Upgrade** and press ENTER.

6. At the **Install Base S/W Upgrade** screen, when displayed status is "Ready", press the START softkey to initiate the upgrade. The IND570 will indicate that it is working. DO NOT power down the IND570 terminal during this process.
7. The base upgrade will take approximately 2 minutes. When the upgrade is complete, the IND570 will display an "Upgrade Successful" message.

## 5.7. Restore Scale Data

- This feature is only available in POWERCELL terminals, and should only be used when connected to a PowerDeck floor scale.

During the original factory configuration of a PowerDeck floor scale, a complete set of System Configuration Data for the platform is stored in each of the four (4) POWERCELL load cells in the platform. The System Configuration Data set includes:



- |                           |                                 |  |
|---------------------------|---------------------------------|--|
| • Version                 | • Factory calibration GEO value | • Initial zero counts                  |
| • Number of load cells    | • Field calibration GEO value   | • Test load 1 weight                   |
| • Platform serial number  | • Primary weight unit           | • Test load 1 counts                   |
| • Platform model number   | • Scale capacity                | • Load cell shift values for all cells |
| • Calibration weight unit | • Scale increment size          | • Load cell calibration zero counts    |

The IND570 has the ability to read this stored System Configuration Data and use it to create a usable, basic weighing system without applying test weights during initial installation. This IND570 feature, known as Restore Scale Data, is intended for use when a new PowerDeck floor scale and new IND570 POWERCELL terminal are combined and will be commissioned on-site, in the following scenarios:

- A new PowerDeck floor scale and new IND570 POWERCELL terminal are combined and must be commissioned on-site
- Repair situations where the IND570 terminal or the IND570 POWERCELL main board must be replaced and there is no back-up available for the terminal.
- Situations where the user feels it is necessary to restore the platform factory default settings to the load cell system.

For the use cases noted above, the following conditions must be true:

- The IND570 POWERCELL terminal must be connected to a PowerDeck platform
- The terminal is configured for use with a PowerDeck floor scale. The setting at **Scale > Type > Application** must be **Floor**, and the **# of Load Cells** must be **4**
- The platform Model and Serial Number fields in the terminal are blank

Platform Model and Serial number fields can be viewed by pressing the RECALL INFORMATION  softkey on the terminal Home page and then the SYSTEM INFORMATION RECALL  softkey on the Recall screen.

- 2-4 of the POWERCELL load cells in the platform have matching System Configuration Data

If only 2 of the POWERCELL load cells have matching data, the remaining 2 cells must have independently unique System Configuration Data. They cannot be another matched pair. In a situation where there are of 2 matching pairs of System Configuration Data, the terminal will not know which data set is original to the platform and should be used. In this situation, neither set of data will be used and the Restore Scale Data function cannot proceed.

- The terminal is not metrologically sealed

### 5.7.1. Initial Commissioning Procedure

The steps below represent a typical PowerDeck installation procedure where the Restore Scale Data feature will be utilized.

1. Physically level the PowerDeck platform with a bubble level.
2. Shim, if necessary, to eliminate platform "rocking".
3. Power-up the terminal and configure for use with a PowerDeck floor scale. Navigate in setup to **Scale > Type > Application** and select Floor. Program the # of Load Cells to **4 (four)**.
4. Remove power from the terminal and connect the PowerDeck platform via the provided M12 connector.
5. Power-up the terminal.
6. Respond the "Use factory calibration?" prompt with a Yes or No. If No is selected, the restore process is cancelled and normal power-up continues.



**Figure 5-4: Factory Calibration Prompt**

7. If **Yes** is selected, the terminal will read the stored System Configuration Data from the load cells and load them into the terminal.
8. If data restore is successful, the terminal will prompt for a GEO code entry. If there was a GEO value in the System Configuration Data, then the terminal pre-populates the display with this value. Enter the correct GEO value for the installation location and press OK to accept. GEO values can be found in Appendix E, **GEO Codes**.
9. Once the GEO code is confirmed, the terminal completes the configuration process and restarts.
10. Once the scale data restore is complete, the platform should be levelled using the utility provided in setup at **Maintenance > Run > Diagnostics > Scale > Leveling Guidance**. Refer to section 5.8 for details.

## 5.7.2. Manual Restore of PowerDeck System Configuration Data

Situations may arise where a PowerDeck system needs to be restored to the original factory configuration. A manual trigger of the Restore Scale Data functions is available in setup at **Maintenance > Run > Diagnostics > Restore Scale Data**.

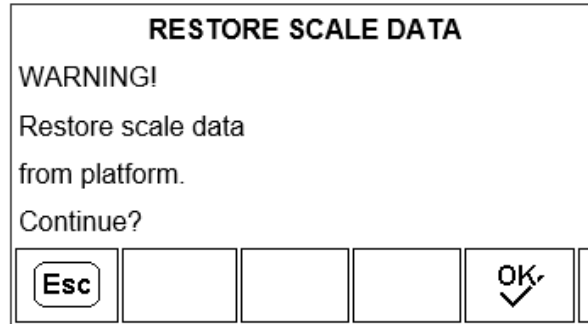



Figure 5-5: Manually Restore Scale Data

1. Press OK  to manually trigger the restore of original System Configuration Data from the PowerDeck load cells. Select ESCAPE  to cancel and return to the setup menu.
2. Once Restore Scale Data is triggered, the terminal will display a **Working...** message as it attempts to read and validate the System Configuration Data in the load cells. If the data in the load cells cannot be read or validated, a restore failure message is displayed. Press ENTER to clear the message and return to the setup menu.
3. If the System Configuration Data is successfully validated, the terminal prompts for a GEO code entry. If there was a GEO value in the System Configuration Data, then the terminal pre-populates the display with this value. Enter the correct GEO value for the installation location and press OK to accept. GEO values can be found in Appendix E, **GEO Codes**.
4. Once the GEO code is confirmed, the terminal completes the configuration process.
5. Once the scale data restore is complete, the platform should be levelled using the utility provided in setup at **Maintenance > Run > Diagnostics > Scale > Leveling Guidance**. Refer to section 5.8 for details.

## 5.8. Leveling Guidance

- This feature is available only in POWERCELL terminals used with PowerDeck floor scales.

To assure maximum weighing accuracy and reliable calibration, it is important that floor scales are installed such that an approximately equal dead load is placed on each load cell.

During factory calibration of a PowerDeck floor scale, the zero counts of each load cell (at a no-load condition) are stored in the load cell along with other initial factory data. When a PowerDeck floor scale is first installed, its accuracy is enhanced by ensuring that it is levelled so that the current cell counts match the stored, factory calibration values as closely as possible.

The Leveling Guidance feature in IND570 POWERCELL terminals provides a graphical comparison of the current counts vs. the factory calibration counts stored in each load cell of a PowerDeck

platform. This feature is provided as a tool for the service technician during installation, and can be accessed in setup at **Maintenance > Run > Diagnostics > Scale > Leveling Guidance**.

- In order for Leveling Guidance to be available, the setting at **Scale > Type > Application** must be **Floor** and the **# of Load Cells** must be **4**.
- The installation guidance is valid **only for platforms with all the original load cells in place**. It should not be used for platforms in which one or more load cells have been replaced.
- A bubble level should be used to initially level the PowerDeck platform before accessing the Leveling Guidance feature.



**Figure 5-6: Leveling Guidance Graphic Display**

The Leveling Guidance graphic display represents a PowerDeck floor scale and assumes that the load cells are addressed as node 1 through 4 starting with the corner where the home-run cable exits and moving in a clockwise direction.

The counts displayed in the center of the graphic indicate how many counts the current reading is above or below the stored factory value. The load cell with the largest negative count variance from the stored factory value is highlighted – cell 1 in the example above. This indicates that this load cell should be shimmed first.

The display updates automatically as the count variances of each load cell change, so shims can be added or subtracted in an attempt to achieve an acceptable count variance. An acceptable count variance is determined by the platform size, capacity and the number of increments as defined in the platform installation manual.

## 5.9. Problem Diagnosis and Troubleshooting

When properly used and maintained, the IND570 will provide years of reliable service to a customer. In the unlikely event that the IND570 experiences performance issues, consult Table 5-3 for a list of symptoms and suggestions for resolving problems that might arise. Additional information found in section 0, **Troubleshooting**, will help determine if a problem exists with the IND570 or has an external cause.

If a problem arises that is not listed in Table 5-3, or if the recommended corrective measures do not resolve the issue, contact an authorized METTLER TOLEDO service representative for assistance.

- Always use qualified electricians to test for problems with the AC or DC power source.

**Table 5-2: Performance Symptoms and Potential Corrective Measures**

Symptom	Suggested Corrective Measures
Display appears to be blank and no digits or text can be seen	<ol style="list-style-type: none"> <li>1. Press any key on the terminal keypad.</li> <li>2. If there is still no visible display, power cycle the terminal.</li> <li>3. After power cycle, if nothing can be seen on the display, proceed to the Power Test to confirm the source of AC or DC power is OK</li> <li>4. If external power is confirmed, check the status of the 12 VDC LED on the power supply (refer to section 5.11.1.1.1, <b>Power Supply LED</b>).</li> <li>5. If the 12 VDC is confirmed, confirm that all harnesses from the power supply to the main board and to the display PCB are connected and free of breaks or open wire connections.</li> <li>6. Check LED 4 on the main board PCB (see Figure 5-19). If LED is OFF, there is no power to the main board processor and the main board must be replaced.</li> <li>7. If LED 4 on the main board is ON, contact an authorized METTLER TOLEDO service representative for assistance.</li> </ol>
Missing information from the display or data not readable	<ol style="list-style-type: none"> <li>1. Use the internal display diagnostic test (refer to section 5.11.2.1, <b>Display Test</b>) to identify if there are isolated problem areas on the display determine if the problem is internal or external to the terminal.</li> <li>2. If a problem exists, replace the display board and gasket or contact an authorized METTLER TOLEDO service representative for assistance.</li> </ol>
Weight is fluctuating uncontrollably	<ol style="list-style-type: none"> <li>1. View Terminal Status. Determine if Signal Quality is "OK".</li> <li>2. Contact an authorized METTLER TOLEDO service representative for assistance.</li> </ol>
Weight display does not change or is blanked	<ol style="list-style-type: none"> <li>1. View Terminal Status. Determine if Excitation voltage measurement is "OK". If not "OK", refer to section 5.11.1.3, <b>Load Cell and IDNet Power</b>, for further information and instruction. If "OK", proceed to step 2.</li> <li>2. Check wiring between the terminal and the scale/load cell. Look for sharp angles, broken wires, etc.</li> <li>3. Check wiring connection at the scale/load cell. Look for broken wires, open connections or mis-wiring.</li> <li>4. Check wiring connection at the terminal. Look for broken wires, open connections or mis-wiring.</li> <li>5. Contact an authorized METTLER TOLEDO service representative for assistance.</li> </ol>
Weight is shown on the display, but the terminal is not connected to a platform.	<ol style="list-style-type: none"> <li>1. When no platform, load cell or simulator is connected to the terminal, the weight display might show a random number, positive, negative, out of range, or continuously fluctuating. These random numbers are the result of electrical noise at the amplifier input. These random numbers do <b>not</b> indicate that IND570 requires service.</li> </ol>
"Plug in IDNet" message is shown (IDNet terminals only)	<ol style="list-style-type: none"> <li>2. Confirm the IDNet connector is securely attached to the terminal.</li> <li>3. Check wiring between the terminal and the IDNet base. Look for sharp angles, broken wires, cuts, etc.</li> <li>4. Refer to section 5.11.1.3, <b>Load Cell and IDNet Power</b>, for further information and instruction or contact an authorized METTLER TOLEDO service representative for assistance.</li> </ol>



Symptom	Suggested Corrective Measures
Low excitation voltage error has occurred	<ol style="list-style-type: none"> <li>1. View Terminal Status to determine if current Excitation voltage measurement is "OK".</li> <li>2. Refer to section 5.11.1.3, <b>Load Cell and IDNet Power</b>, for additional information and instructions or contact an authorized METTLER TOLEDO service representative for assistance.</li> </ol>
Setup parameters change unexpectedly or programming is lost	<ol style="list-style-type: none"> <li>1. View Terminal Status screen. Determine if current battery voltage measurement is "OK".</li> <li>2. Replace the internal battery assembly or contact an authorized METTLER TOLEDO service representative for assistance.</li> </ol>
Keypad not responding	<ol style="list-style-type: none"> <li>1. If none of the keypad is responding, confirm there is no active discrete input programmed as "Disable Keypad". Refer to the <b>Discrete I/O</b> section in Chapter 3, <b>Configuration</b>, for details on Discrete I/O programming.</li> <li>2. If keypad response is intermittent, or problems are only occurring with some of the keys, use the internal keyboard diagnostic test (refer to section 5.11.2.2, <b>Keyboard Test</b>) to determine which keys are failing.</li> <li>3. Contact an authorized METTLER TOLEDO service representative for assistance in replacing the keyboard overlay.</li> </ol>
No communication from a programmed serial port	<ol style="list-style-type: none"> <li>1. Check communication wiring to external device. Confirm the transmit and receive lines of the terminal are reversed at the external device connection (terminal TXD to device RXD and device RXD to terminal TXD).</li> <li>2. Use the internal serial diagnostic test (refer to section 5.11.2.4, <b>Serial Test</b>) to determine if the problem is internal or external to the terminal.</li> <li>3. If problem is internal, contact an authorized METTLER TOLEDO service representative for assistance.</li> </ol>
No network communications	<ol style="list-style-type: none"> <li>1. Check the terminal's physical connection to the network both at the terminal's RJ45 port and the network's RJ45 port.</li> <li>2. If unable to make a socket connection on the IND570, view Terminal Health Status to determine number of active SDS Logins. Only 3 are allowed. If this # is 3 and there are no intentional active socket connections, power cycle the terminal to clear all existing socket connections.</li> <li>3. Use the internal network diagnostic test (refer to section 5.11.2.6, <b>Network Test</b>) to determine if the problem is internal or external to the terminal.</li> <li>4. If problem is internal, contact an authorized METTLER TOLEDO service representative for assistance.</li> </ol>
Discrete inputs or outputs don't operate	<ol style="list-style-type: none"> <li>1. Confirm the IND570 is recognizing the installed Discrete I/O option board.</li> <li>2. Use the discrete input and output internal diagnostic test (refer to section 5.11.2.5, <b>DIO Test</b>) to determine if the problem is internal or external to the terminal.</li> <li>3. If the problem is internal, contact an authorized METTLER TOLEDO service representative for assistance.</li> </ol>
External keyboard won't connect	<ol style="list-style-type: none"> <li>1. Confirm the USB port is enabled for keyboard connection. Refer to the <b>USB Access/Security</b> section in Chapter 3, <b>Configuration</b>.</li> <li>2. Unplug and reconnect USB keyboard. If no identification prompt is shown, contact a METTLER TOLEDO service representative.</li> </ol>



Symptom	Suggested Corrective Measures
Node x No Response or Node x Not found error messages displayed	<ol style="list-style-type: none"> <li>1. Check POWERCELL Node x load cell connecting cables.</li> <li>2. Using POWERCELL mapping diagram, determine which network position might be causing the issue.</li> <li>3. Check cable and load cell connections. Replace if necessary.</li> </ol>
Weight display shows dashes	<ol style="list-style-type: none"> <li>1. If a SICSpro Cable-Free Floor Scale (CFS) is connected, observe the home screen; if the alternating messages "Platform is asleep" and "Add weight to wake up," give the scale a sudden jolt to return to normal functionality.</li> </ol>
Bluetooth error – scale Or Bluetooth error – IND570	<ol style="list-style-type: none"> <li>1. Check the connection of the indicated Bluetooth module (in the CFS, or attached to the IND570).</li> <li>2. If the connection is correct, replace the affected module and re-pair the CFS.</li> </ol>
Screen displays "Bluetooth OK – No scale data"	<ol style="list-style-type: none"> <li>1. In a CFS, the Bluetooth connection is active, but the scale platform is not sending weight data. Refer to the platform's documentation for diagnostic checks.</li> </ol>

## 5.9.1. Troubleshooting

The troubleshooting activities described here are intended to assist a user in identifying whether a problem is in the IND570 terminal or has an external cause.

### 5.9.1.1. Diagnostic LEDs

#### 5.9.1.1.1. Power Supply LED

The power supply for the analog, IDNet and SICSpro versions develops 12 VDC to send to the main PCB and display PCB. An LED near the 12 VDC output connection of the power supply will confirm the presence of its 12 VDC output.

When 12 VDC is present, the LED is ON. If voltage is absent or outside the required performance range, the LED will be OFF. If the LED is OFF, replace the power supply PCB or contact an authorized METTLER TOLEDO service representative for assistance.

- Note that there is no LED on the power supply of the POWERCELL version. Refer to the POWERCELL Main Board LED 4 and LED 12 descriptions below for the POWERCELL power supply LEDs.

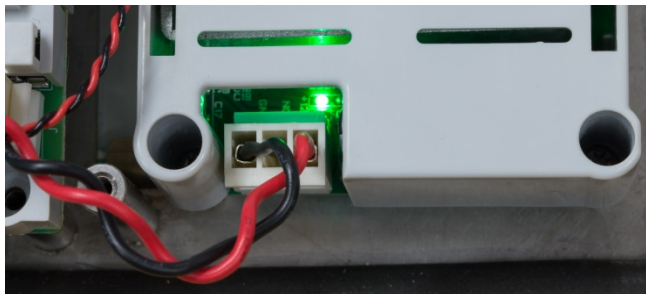
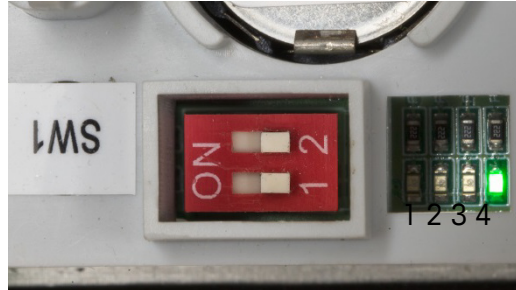

Figure 5-7: 12-VDC LED on Power Supply

5.9.1.1.2. Analog and Digital Main Board LEDs

The behavior of LEDs 1 through 4 varies depending on which main board is installed and what version of boot code and firmware is loaded. Refer to the tables below for analog and digital main boards, respectively.



Harsh Environment Model



Panel Mount Model

**Figure 5-8: Position of LED 4 on Main Board PCB**

**Table 5-3: Analog Main Board, LEDs 1, 2 and 3**

Analog				
Boot Code	Firmware	LED 1	LED 2	LED 3
1.00.0004	≤ 2.00.0031	ON	ON	ON
1.00.0006	≥ 2.00.0033	ON	OFF	OFF

**Table 5-4: Analog Main Board, LED 4**

Analog	
LED 4	Definition
OFF	No power to main board
ON	Power supply on main board OK

**Table 5-5: Digital (IDNet and SICSpro) Main Boards, LEDs 1, 2 and 3**

Digital - IDNet and SICSpro				
Boot Code	Firmware	LED 1	LED 2	LED 3
1.00.0004	≤ 2.00.0031	ON	ON	ON
1.00.0006	2.00.0033 – 2.00.0045	ON	OFF	OFF
1.00.0006	≥ 2.00.0086	ON	Flashes for TxD	Flashes for RxD

**Table 5-6: Digital (IDNet and SICSpro) Main Boards, LED 4**

Digital - IDNet and SICSpro		
Firmware	LED 4	Definition
≤ 2.00.0045	OFF	No power to main board
	ON	Power supply on main board OK
≥ 2.00.0086		Turns ON for a few seconds at power up then turns OFF and remains OFF

### Behavior of LEDs 2 and 3 on Digital Main PCB

In terminals with a digital scale interface, the behavior of main PCB LEDs 2 and 3 differs depending on whether a platform is connected or not.

With no platform connected:

- LED 3 will turn ON about 3-4 seconds after power-up, remain ON for about 1 second then turn OFF and remain OFF.
- LED 2 will begin to flash about 5 seconds after power-up then continue to flash.

With a working platform connected:

- LED 3 will turn ON about 3-4 seconds after power-up, remain ON for about 1 second then turn OFF. There will be random OFF and ON events while communication with the terminal is established. After communication is established, it will flash at about 6-7 times per second.
- LED 2 will begin to flash about 5 seconds after power-up. There will be random OFF and ON events while communication with the platform is established. After communication is established, it will flash at about 6-7 times per second.

#### 5.9.1.1.3. POWERCELL Main Board LEDs

The POWERCELL main board has three groups of diagnostic LEDs numbered from LED 1 through LED 12. The LEDs are shown in Figure 5-20.

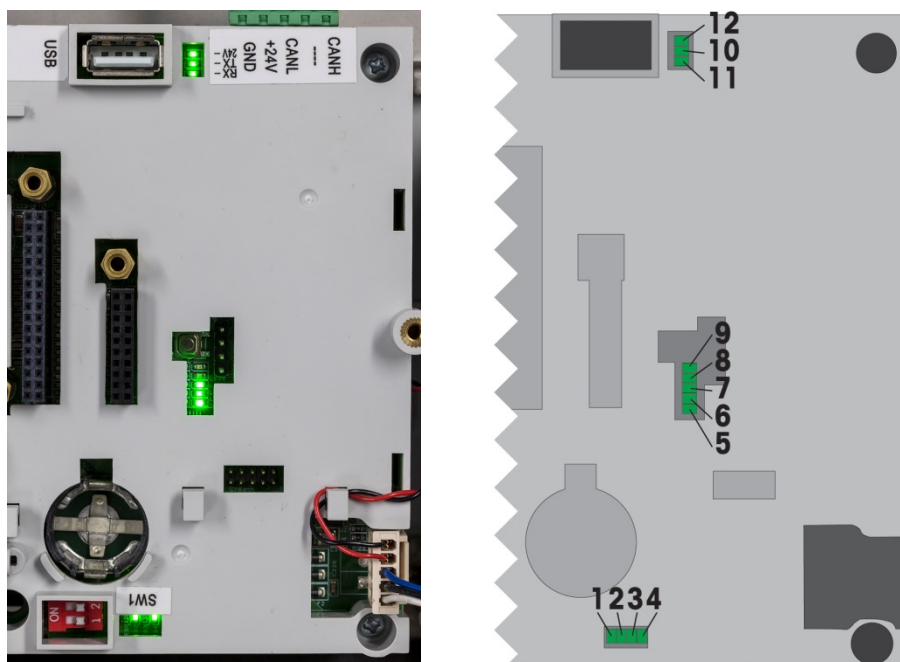

**Figure 5-9: POWERCELL Main Board LEDs**

The functions of the LEDs are described in the tables below. Note that LED 1 through LED 3 will sequence through different conditions during a power cycle as shown. When working correctly, LED 2 and LED 4 will remain ON during operation.

**Table 5-7: Historic Description of LEDs 1 to 3**

<b>POWERCELL V1.0031 – V1.00.0060</b>			
<b>Function</b>	<b>LED 1</b>	<b>LED 2</b>	<b>LED 3</b>
Step 1	ON	ON	ON
Step 2	OFF	OFF	OFF
Step 3	ON	OFF	OFF
Step 4	ON	OFF	ON
Normal operation	OFF	ON	OFF

**Table 5-8: Current Description of LEDs 1 to 3**

<b>POWERCELL V2.0001 – V2.01.0001</b>			
<b>Function</b>	<b>LED 1</b>	<b>LED 2</b>	<b>LED 3</b>
Step 1	ON	ON	ON
Step 2	OFF	OFF	OFF
Step 3	ON	OFF	OFF
Step 4	ON	OFF	ON
Normal operation	ON	OFF	OFF

**Table 5-9: Description, LED 4**

<b>LED</b>	<b>Status</b>	<b>Definition</b>
4	ON	Power Supply on main board OK

**Table 5-10: Description, LED 4 to LED 9**

<b>LED</b>	<b>Status</b>	<b>Description</b>
5	Flashing	POWERCELL network processor OK
6	OFF	Software Stack OK
7	ON	Software Stack OK
8	--	Not Used
9	Flashing very quickly	Interrupt status

**Table 5-11: Description, LED 10 to LED 12**

<b>LED</b>	<b>Status</b>	<b>Description</b>
10	Flashing	Transmit data to load cells
11	Flashing	Receive data from load cells
12	ON	POWERCELL network voltage OK

## 5.9.1.1.4. Ethernet TCP-IP LEDs

The three LEDs on the optional Ethernet PCB have the following diagnostic functions:

- ACT LED: Activity

Flickering = Communication present

- SPD LED: Speed

ON = 100Mb/s

OFF = 10 MB/s

- LINK LED: Link

ON = Ethernet link is established

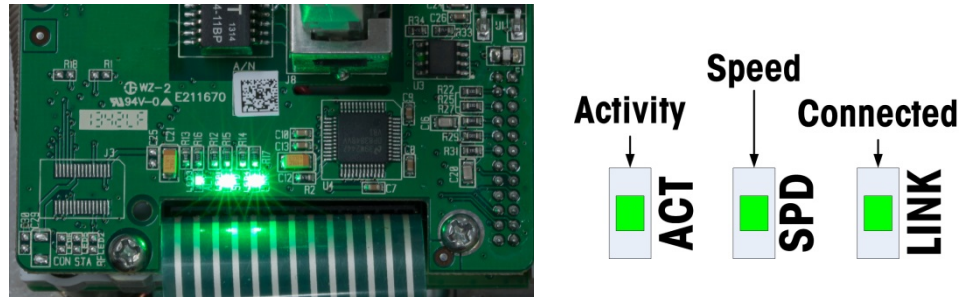

Figure 5-10: Ethernet TCP/IP LEDs

#### 5.9.1.1.5. PLC Option LEDs

Information on the function of LEDs present of the various PLC option PCBs can be found in the **IND570 PLC Interface Manual**, available for download at [www.mt.com/IND570](http://www.mt.com/IND570).

#### 5.9.1.2. Power Test

If the display is blank, a low excitation voltage error has occurred, or there are intermittent problems occurring with the IND570, check the condition of the power supply.

First, use a multi-meter to check the input power at the terminal strip on the IND570 power supply.

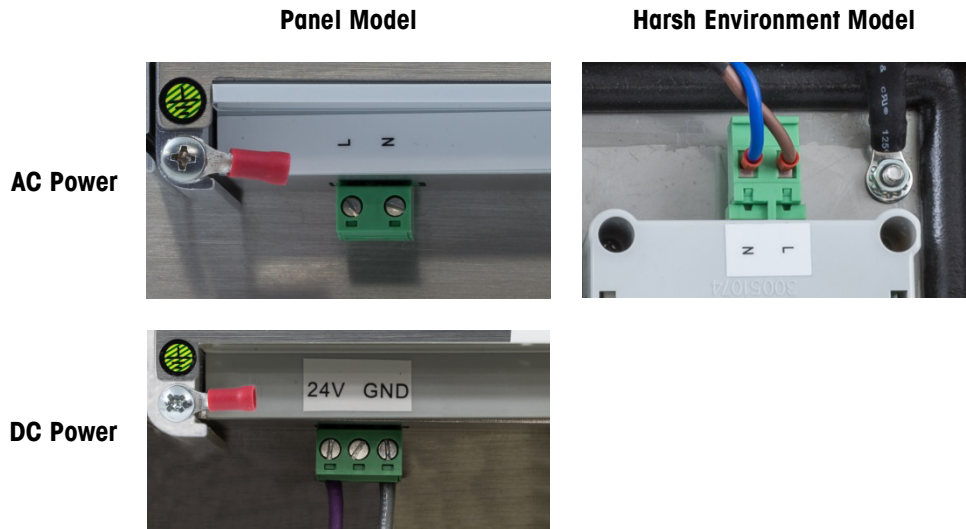

Figure 5-11: AC and DC Power Test Points – Panel (left) and Harsh (right)

Incoming power must be within the following ranges, depending on the type of power supply, AC or DC:

Power Supply	Input Voltage Range
AC Power Supply	-15% to +10% of the standard 100–240 voltage range
DC Power Supply	24 VDC , -15% to +10%

If insufficient power is present, have a qualified electrician at the site restore power at the source. After power is restored, test the IND570 for correct operation.

If sufficient voltage is present at the source, the power supply should be checked next.

### 5.9.1.3. Load Cell and IDNet Power

The power to operate an IDNet or SICSpro base and the excitation voltage for analog load cells are developed from the 12 VDC supplied from the power supply to the main PCB. The IND570 has short-circuit protection built into the main board. If the IDNet or SICSpro base or analog load cell circuit draws too much current (for example, when shorted to ground), the 12 VDC supply will shut itself off. After the protection circuit is triggered, the terminal will automatically recover (after a brief delay) when the short is removed, and the 12VDC will become active.

#### 5.9.1.3.1. Analog Load Cells

The IND570 provides an excitation voltage monitoring feature. The terminal performs a measurement check of the excitation voltage in the following circumstances: at power-up, 1x time per minute during normal operation, and every time the Terminal Status pages are viewed by a user.

During these excitation voltage checks, the IND570 captures and averages 3 real time measurements and reports this average as the current excitation voltage on the Terminal Status View.

- If the measured voltage is less than 9.0V, a warning message will be shown in system line "Low Excitation Voltage" and the Service Icon will activate.
- If the measured voltage is less than 5.0V, a pop-up error message will display "Excitation Voltage Below Limit" and the Service Icon will activate

If either excitation voltage error occurs, first check the current excitation voltage measurement on the Terminal Status View. If the current measure is below 9.0V, take the following steps:

- 1) Check the 12VDC LED on the power supply.
  - a. If the 12VDC LED is ON, go to step 2.
  - b. If the 12VDC LED is OFF, replace the power supply.
- 2) If the 12VDC LED on the power supply is ON, power the terminal down.
- 3) Disconnect the load cell homerun cable. Wait 90 seconds. Reapply power to the terminal with the load cell cable disconnected.
- 4) View the excitation voltage measurement shown on the Terminal Status View.
  - a. If the excitation voltage measurement is now "OK" (>9.0V), check the analog load cell(s) and load cell wiring for defects.

- b. If the excitation voltage measurement is still below 9.0V, it is recommended that the IND570 be powered down again with the load cell homerun cable disconnected. Wait an additional 5 minutes, reconnect the homerun cable, and power up the IND570.

The IND570 provides a temperature sensitive component to protect the excitation circuit in rare cases where the load cell circuit demands excessive current (in cases of shorted cables or moisture in the load cell cable for instance). If this component is activated due to high current draw of the load cell network, after disconnecting the load cell homerun cable, it will take several minutes for the component to "cool down" before it will support normal operation again. If the terminal is powered back on too soon, (without sufficient cool down time), the excitation circuit will not recover and it will appear the main board is defective (low excitation) when in fact, the main board is working as designed but has not been powered down long enough to recover. In this situation, the issue is caused by excessive current draw by the load cells and the load cell circuit should be further tested.

If after 5 minutes the excitation voltage measurement is still below 9.0V, it is likely that the analog main board has sustained damage and should be replaced.

If either excitation voltage error occurs, check the current excitation voltage measurement on the Terminal Status View. If the current measure is below 9.0V, contact an authorized METTLER TOLEDO service provider for further assistance.

#### 5.9.1.3.2. IDNet and SICSpro Bases

If the 12 VDC LED on the power supply is ON and a "Connect IDNet Base" or "Connect SICSpro Base" error has occurred and it is confirmed that the base is correctly connected to the terminal, power the terminal down, disconnect the base, wait 30 seconds, then reapply power. Plug the base back into the terminal. If the "Connect IDNet Base" or "Connect SICSpro Base" error message continues, contact an authorized METTLER TOLEDO service provider for further assistance.

#### 5.9.1.3.3. POWERCELL Load Cells

If LED 12 on the Main Board is ON but the terminal is reporting a "Not Found" error for all nodes, check the homerun cable wiring and load cell network connections. If the "Not Found" error message for all nodes continues, contact an authorized METTLER TOLEDO service provider for further assistance. If LED12 on the Main Board is OFF, it indicates the POWERCELL network voltage is off. The IND570 POWERCELL terminal provides short circuit protection for the load cell network voltage. If the network pulls too much current (such as when the supply line is shorted to ground), the terminal will switch off the voltage. After switching off the voltage, the terminal will check if the short circuit is still present or not every few minutes. When the short is removed, the terminal will switch the power back on again automatically. After disconnecting the network from the terminal, allow 1 minute for the terminal to switch the power back on before testing.

#### 5.9.1.4. Cable-Free Floor Scale Power

Two battery warning messages are provided for the self-powered Cable-Free Floor Scale. The first message appears when approximately 12 eight-hour days of battery life remain. The second, more critical, warning appears when there are approximately 5 eight-hour days of battery life remaining.



These estimates of remaining battery life are based on continuous use for eight hours a day at a 25° C nominal temperature, and may vary based on the specific application. METTLER TOLEDO recommends replacement of the battery immediately when the second warning is shown.

Displayed Message	Approx. Battery Voltage	Est. Battery Life Remaining*	Required Action
Platform battery low	6.7 volts	12 days	Contact authorized METTLER TOLEDO service to schedule battery replacement in the next 30 days
Warning! Platform battery voltage very low	6.4 volts	5 days	Have battery replaced by authorized METTLER TOLEDO service immediately

\* This is an estimated value and may vary by as much as 50% based on the actual application.

### 5.9.1.5. WiFi Diagnostics

Only WiFi modules with firmware version 6.00 or newer are fully compatible with the IND570. If a feature is not working correctly, confirm the module firmware version on the second page of the WiFi Info Recall screen. Refer to Figure 5-23 for an example. If the module has earlier firmware, replace the module with one that is running 6.0.0 or newer.

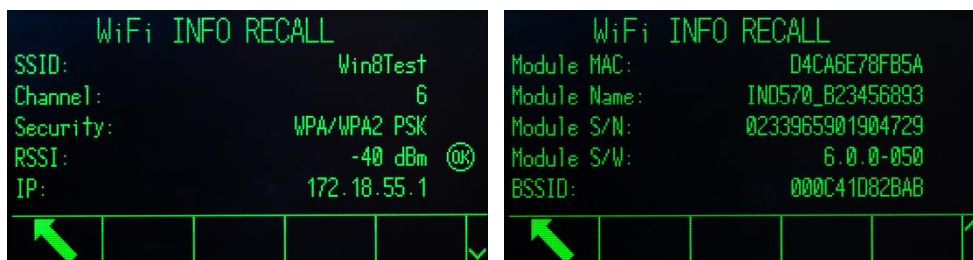

Figure 5-12: WiFi Information Recall Screens

#### 5.9.1.5.1. WiFi Module Status LED

If the IND570 WiFi option is not working properly, note the color of the LED on the module. This LED indicates the status of the module and the WiFi connection. Refer to Table 5-13. When the LED is blue and occasionally blinks, this indicates network connectivity and normal operation.

Table 5-12: WiFi Module Status LED

LED Color	Status
Green/Yellow	Idle state
Purple	Connection in progress
Blue	Connection active
Blue - blinking	Connection active with data traffic
Red – blinking	Error

#### 5.9.1.5.2. Startup LED Sequence

If all programming has been configured properly and the programmed Wireless Access Point (WAP) is available, the LEDs will follow the sequence shown in Table 5-14 after the IND570 is power cycled. Note the times listed are approximate.



**Table 5-13: "Connection OK" LED Sequence**

LED Color	Timing
Green	2 seconds
Yellow	5 seconds
Purple	1 second
Blue	4 seconds
Green	6 seconds
Purple	1 second
Blue	Constant with occasional blink

If there is a problem with the configuration or the WAP is not available, the LEDs will follow the sequence listed in Table 5-15 when the IND570 is powered on. Note the times listed are approximate.

**Table 5-14: "No Connection" LED Sequence**

LED Color	Timing
Green	2 seconds
Yellow	5 seconds
Purple	5 second
Green/Yellow	1 second
Purple	4 seconds
Green	Constant with occasional blink

5.9.1.5.3. WiFi Signal Strength

One of the keys to good WiFi communication is having a strong WiFi signal. When connected to a network, the IND570 will indicate the WiFi signal strength in the upper right corner of the display. If the signal strength changes, this symbol will also change. Refer to Table 5-16.

**Table 5-15: Signal Strength Graphic**

Symbol	Description	Signal Strength Range
■	Very weak signal	-71 dBm and below
■ ■	Weak signal	-56 to -70 dBm
■ ■ ■	Acceptable signal	-40 to -55 dBm
■ ■ ■ ■	Strong signal	-39 dBm and above

More details about the WiFi connection are available in the **WiFi Info Recall** display shown in Figure 5-23. Monitor the RSSI value (signal strength) as you reposition the WiFi module to make sure the WiFi module is positioned to receive the strongest WiFi signal. The position of the module when using the remote mounting option and the module's orientation inside the plastic cover will both affect signal strength.

- When using the remotely-mounted WiFi option, isolating the metal enclosure using nylon mounting hardware and a rubber isolation pad may improve the signal performance.

In addition to the signal strength indication, when the WiFi option is installed but not connected to a network the graphic shown in Table 5-17 will be displayed in the upper right corner of the screen.

**Table 5-16: WiFi Signal Disconnected Graphic**

Symbol	Description
✘	WiFi disconnected

#### 5.9.1.5.4. Diagnostic WAP Scan

In setup at the **Maintenance > Run > Diagnostics > WiFi Scan** branch, a scan can be triggered that provides details of the 10 access points with the strongest signal. The channel used and the signal strength are shown with the results, to indicate more detail about available WAPs. Refer to Figure 5-24.

WiFi SCAN		
SSID	Channel	RSSI
1 MTGLOBAL2G	1	-40
2 IWAREH	1	-40
3 MTMOBILE	1	-40
4 MTDEVICES	1	-40
5 MTCHECT	1	-40

**Figure 5-13: Diagnostic Scan Results Screen**

#### 5.9.1.5.5. WiFi Connecting and Disconnecting

If the WAP is up and running, the IND570 will connect automatically when it is powered up.

If the IND570 is powered up first and then the wireless access point is powered up, the IND570 will automatically connect after a short delay. Normally, no action is required to reestablish a network connection after the terminal is turned off and on.

The IND570 will display a system line message indicating the status of the WiFi connection. Whether the connection fails or succeeds, additional information may be provided by the terminal. These potential messages are:



- WiFi connected to access point
- WiFi module removed
- WiFi AP unavailable
- Invalid WiFi passphrase/PSK
- WiFi module error

#### Troubleshooting

If there is difficulty connecting to a network via WiFi, or sustaining a connection, please review the following items for topics to investigate.

- Some WAPs will "hide" their SSIDs and not respond to a WiFi scan. In this case, the SSID must be obtained from the customer.
- Be aware of the line-of-sight between the IND570 WiFi module and the WAP. Objects placed in the line-of-sight path can influence the WiFi signal causing a dropped connection. After the object is moved, the connection could reestablish itself causing an intermittent communication.
- Routers and switches often "manage" networks, and they may drop connections to devices that send data infrequently. This can cause intermittent communication.

#### 5.9.1.6. Battery Test

The IND570 can perform an internal measurement of the BRAM battery voltage. Press the INFORMATION RECALL  softkey, then press the SERVICE ICON softkey . TERMINAL STATUS softkey  takes the user to the Terminal Status Report screens, where additional system performance details are available, including the current battery voltage. The voltage listed on the left is the voltage as it was measured at last calibration. The battery voltage listed on the right is the current measurement taken as the user entered the Terminal Status screens.

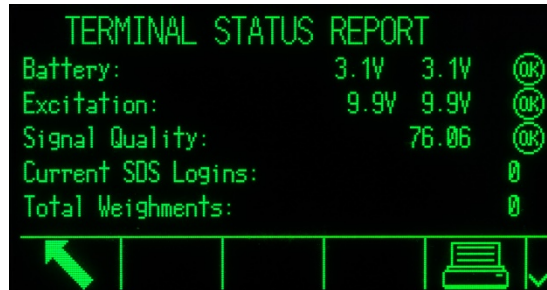



Figure 5-14: Terminal Status Screen

### 5.9.2. Built-in Diagnostics Tests

The IND570 provides several internal diagnostic tests that are accessible in setup mode. Press the SETUP softkey  to view the setup menu tree. Use the DOWN navigation key to scroll down the menu tree to Maintenance. Press the RIGHT navigation key to expand the menu tree selections for Maintenance. Scroll down and expand Run. Scroll down and expand Diagnostics. Available diagnostic setup screens include:

#### 5.9.2.1. Display Test

Displays an alternate off/on dot block pattern. After the alternate off/on cycle, the display will return to the menu tree.

#### 5.9.2.2. Keyboard Test

Enables testing of the keyboard. Each key that is pressed will be shown on the display. When testing is complete, press the EXIT softkey  to return to the menu tree.

### 5.9.2.3. Scale

#### 5.9.2.3.1. Load Cell Output

Displays the current load cell output (active weight) in internal counts. When weight is placed on the scale, the number of counts should increase. Press the EXIT softkey  to return to the menu tree.

■ This test is not available with IDNet models.

#### 5.9.2.3.2. Calibration Values

Displays the current calibration values for the scale. If these values are recorded after a scale calibration, and the Main PCB is replaced in the future, the calibration values can be entered here to transfer the previous calibration to the new Main PCB manually. Press the EXIT softkey  to return to the menu tree.

■ This feature is not available with IDNet models.

#### 5.9.2.3.3. Shift Values

Displays the shift adjustment values for POWERCELL load cell scales. The shift adjust values can be viewed and also edited.

#### 5.9.2.3.4. Statistics

Displays statistical information for the scale such as the total number of weighments, the number of scale overloads, the peak weight weighed on the scale, total number of zero commands and failed zero commands. These are very helpful when diagnosing scale problems. This information is also available for view on the Terminal Status screens.

### 5.9.2.4. Serial Test

Enables testing of the transmit and receive functions on the serial (COM) ports. Select the COM port to be tested using the COM Port selection box . Only installed and recognized serial ports are available for testing.

- Press the START softkey  and a data string is output repeatedly approximately once every three seconds. The data is: [Testing COMx: nn] where "x" is the COM port and "nn" is an incrementing value beginning at 00 and continuing to 99. Each transmission increments this number by one.
- Place a jumper wire between the transmit and the receive terminals (Figure 5-26) on the port being tested. If the transmit and receive functions of the serial port are functioning correctly, the same data string that is transmitted will display in the receiving field.

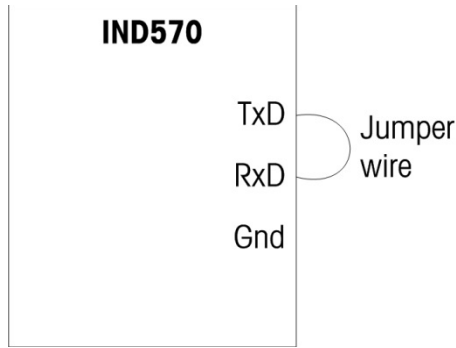

**Figure 5-15: Jumper Wire Between Transmit and Receive Terminals**

- If another device is connected to the receiving port, any ASCII data received by the IND570 will display in the receiving field.
- To stop the serial port test, press the STOP softkey .



**5.9.2.5.**

**Discrete I/O Test**

	 <b>WARNING</b>
	<b>THE INTERNAL DISCRETE I/O RELAY OPTIONS #30113540, OR #30113542 MUST NOT BE USED IN AN IND570xx TERMINAL. FAILURE TO COMPLY WITH THIS WARNING COULD RESULT IN BODILY HARM AND/OR PROPERTY DAMAGE.</b>

Provides a view of the status of the discrete inputs and allows enabling or disabling of the discrete outputs for diagnostic purposes. Expand the Discrete I/O branch by pressing the RIGHT navigation key. Choose if the test will be performed on the local (internal) discrete I/O option or one of the remote ARM100 modules. Press ENTER when that branch is highlighted.

A warning will appear to remind the tester that the outputs can be turned on manually during this test so if manual activation of connected devices is not desired, control power to the discrete outputs should be removed before beginning the test.

	 <b>WARNING</b>
	<b>THE DISCRETE OUTPUTS OF THE IND570 TERMINAL WILL BE MANUALLY ENABLED DURING THIS TEST. REMOVE OUTPUT CONTROL POWER SO EXTERNAL EQUIPMENT WILL NOT BE ENERGIZED BY MISTAKE. EXERCISE CARE WHEN MAKING CHECKS, TESTS AND ADJUSTMENTS THAT MUST BE MADE WITH POWER ON. FAILING TO OBSERVE THESE PRECAUTIONS CAN RESULT IN BODILY HARM AND/OR PROPERTY DAMAGE.</b>

When viewing the test screen, the input status will be shown at the top of the display and the output status will be shown at the bottom of the display. Focus is shown on Output #1 first. In Figure 5-27, Input 1 is on, Output 1 is on, and Output 4 is on and in focus.



Figure 5-16: Discrete I/O Test Screen

Focus can be moved to any of the other outputs by using the RIGHT and LEFT navigation keys. The two softkeys at the bottom of the page will either enable  or disable  the highlighted output.

■ Note that when the Discrete I/O Test screen is exited, all outputs will be turned OFF.

#### 5.9.2.6.

#### Network Test

The network test checks the terminal's Ethernet programming, hardware and firmware. The following tests are run during this diagnostic process:

- TCP/IP Stack
- This IP Address`
- Gateway address
- Email server

Each step will indicate "Testing" during the test then indicate a Pass or Timeout status.

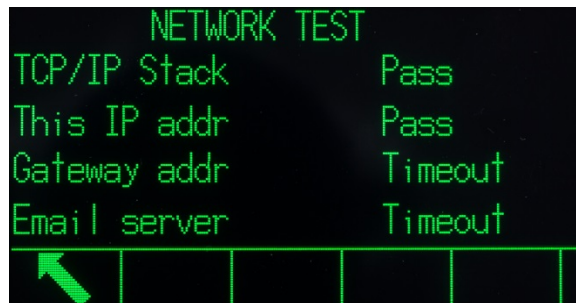

Figure 5-17: Network Test Screen

If the status is shown as Timeout, it indicates that the IP address or gateway address has not been programmed in the terminal (see the **Communication | Network** section of Chapter 3, **Configuration** for information on entering the IP and gateway addresses).

## 5.10. Web Server – Analog, IDNet and SICSprö

The IND570 includes a built-in web server utility that provides valuable tools for examining the operation of the terminal along with installed options and software. Information available through the Web Server includes:

- System hardware and software configuration
- Resource utilization data
- Scale statistics

Web Help, a function within the Web Server, supports the following functions:

- Reading shared data variables, viewed either statically or dynamically
- Writing shared data values
- Remote terminal reset

The Web Server is accessed with a web browser program via an Ethernet connection. Access to the Terminal is provided by using its IP address. An IP address can be manually assigned, or assigned automatically by the network, depending on how DHCP is configured in setup at **Communication > Network > Ethernet**. If DHCP client is enabled, once the terminal is connected to the Ethernet its IP address will appear in the system information screen. After an IP address for the IND570 has been entered or automatically assigned using DHCP, record the address and enter it as the URL in the browser program.

If the connection is successful, the Web Server home page (Figure 5-29) is displayed.

### 5.10.1. Home Page

When the Web Server is first accessed, the Home page shown in Figure 5-29 appears in the browser window.

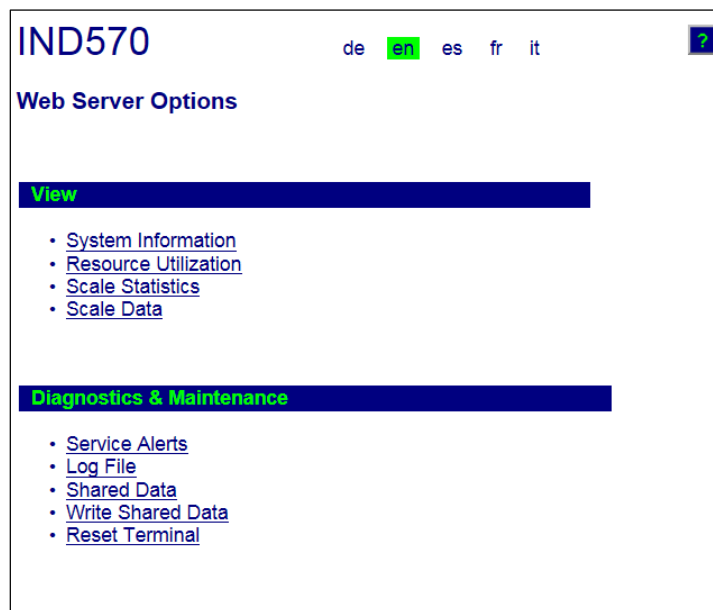

**Figure 5-18: Web Server Home Screen**

Click the links on this page to visit the respective views, each of which is detailed in the following sections.

At the bottom of each page accessed, a HOME button is shown which returns the view to the Home page seen in Figure 5-29 when pressed.

## 5.10.2. Help File

A help file, accessible from each page via the help button  explains the full range of the utility's features. Refer to this file for a full explanation of each of the data and utilities available on each page. Figure 5-30 shows a portion of the help file.

**IND570 Web Help**

**Web Server Options**

The IND570 offers the user valuable tools for examining system operation through the web pages listed below. These include web pages for Shared Data, Shared Data, and Shared Data. The Shared Data web page also provides the ability to write values to shared data after a security login. Two service technicians if the need arises.

- **View / System Information**
  - **Model and ID**  
Shows the terminal model and serial numbers and the three terminal ID fields (ID1, ID2, and ID3)
  - **Software**  
Lists the boot code and operating software versions of the terminal. If Application Software is installed, that information
  - **Equipment List**  
Contains the IND570 Terminal hardware configuration. This list includes all hardware detected except an internal Disc
  - **Channel, Name, Software and Serial Number**  
Shows the programmed name for the scale and the serial number of the scale if it has been entered in setup. When a h
  - **Connected device, Module, and Note**  
Shows the connected device to the terminal.
- **View / Resource Utilization**
  - **Power On**  
Indicates the total power on time, the power on time since last power cycle and number of power on cycles. The Total p
  - **Memory**  
Shows the maximum size of the different types of memory in the terminal.
  - **Voltages**  
Shows the voltages of the battery and excitation in both calibration and current.
- **View / Scale Statistics / Usage**
  - **Usage Time**  
This is the time spent above 1% of the scale capacity threshold, expressed in percent of powered on time.
  - **Usage Cycles / Day**  
This is the average number of load cycles (weight above 1% capacity) per day averaged over the last seven days (zero
  - **Transactions / Day**  
This is the average number of daily print commands for the last seven days. Zero transaction days are ignored.
  - **Total Transactions**  
Total number of scale transactions. This value is reset only during a Master Reset.
- **View / Scale Statistics / Peak Loading**

**Figure 5-19: Help File**

At the bottom of the Help page, a  button allows the user to close this second browser window without exiting the Web Server utility.



### 5.10.3. View Pages

#### 5.10.3.1. System Information

The system information page (Figure 5-31) provides asset information, installed component part numbers, software versions and serial numbers, and installed application software. The **Channel Software** column is not filled unless the terminal is using an IDNet scale base.

**IND570** 

**View / System Information**

Model: IND570  
ID 1: IND570  
ID 2: METTLER TOLEDO  
ID 3: Shipping dock - floor scale

**Software**

Boot: 30101168 1.00.0002  
Standard: 30094864 1.00.0057  
Fill-570: 1.73

**Equipment List**

Analog L/C  
Option: Ethernet  
Option:  
Option: COM2/3DIO solid status board

Channel	Name	Software	Serial Number
1	Scale 1		

**Connected device**      **Module**      **Note**

MT Scoreboard - COM3      ADI420      On pole behind printer  
4x4 MT floor scale      2158 Vertex      Stainless steel  
MT ticket printer - COM3      APR310      On stand behind scale  
Motorola barcode scanner      LS2208      USB port

[Home](#)

Figure 5-20: System Information Page

### 5.10.3.2. Resource Utilization

The resource utilization page (Figure 5-32) gives a snapshot of the current status of the terminal, including power on time and information about the various types of memory used by the IND570.

IND570		
<b>View / Resource Utilization</b>		
<b>Power On</b>		
Total power on time:	2.45 days	
Time since last power on:	0.01 days	
Power on cycles:	12	
<b>Memory</b>		<b>Capacity</b>
Flash Memory	8MB	
Battery Backed RAM	1 MB	
Dynamic RAM	32 MB	
<b>Voltages</b>	<b>Calibration</b>	<b>Current</b>
Battery	3 V	3 V
Excitation	9.9 V	9.9 V
<a href="#">Home</a>		

Figure 5-21: Resource Utilization Page

### 5.10.3.3. Scale Statistics

The scale statistics page (Figure 5-33) shows a variety of data for the scale.

IND570	
<b>View / Scale Statistics</b>	
<b>Usage</b>	
Usage Time	11730.00%
Usage Cycles / Day	3
Transactions / Day	16
Total Transactions	114
<b>Peak Loading</b>	
Peak Weight	568.4 kg
Average Peak Load	543.01%
Total Weight	9167.347 kg
<b>Statistics</b>	
Scale Under Range	8
Scale Overloads	8
Zero Commands	3
Zero Command Failures	1
Zero Command Failures (%)	33.3%
<a href="#">Home</a>	

Figure 5-22: Scale Statistics Page

### 5.10.3.4. Scale Data

The scale data page (Figure 5-34) shows information, including current configuration and calibration values, for the scale. The signal quality display permits troubleshooting of the connection between the IND570 and load cells. When quality is poor, a red bar is displayed. A yellow bar indicates adequate quality, and green bar means the quality is good, as in the example below.

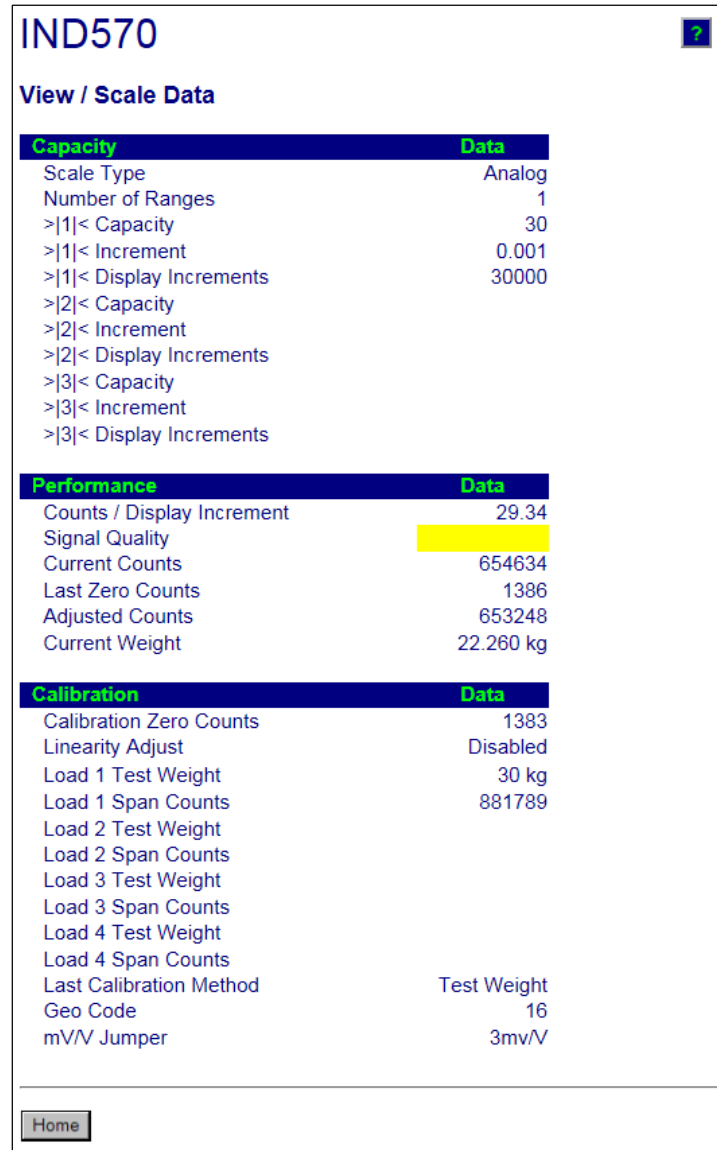

The screenshot displays the 'IND570' scale data page. It features a title bar with 'IND570' and a help icon. Below the title is a 'View / Scale Data' section. The data is organized into three main sections: Capacity, Performance, and Calibration, each with a header row. The 'Signal Quality' row in the Performance section has a yellow bar next to its value, 29.34. At the bottom of the page is a 'Home' button.

IND570	
View / Scale Data	
Capacity	Data
Scale Type	Analog
Number of Ranges	1
> 1 < Capacity	30
> 1 < Increment	0.001
> 1 < Display Increments	30000
> 2 < Capacity	
> 2 < Increment	
> 2 < Display Increments	
> 3 < Capacity	
> 3 < Increment	
> 3 < Display Increments	
Performance	Data
Counts / Display Increment	29.34
Signal Quality	29.34
Current Counts	654634
Last Zero Counts	1386
Adjusted Counts	653248
Current Weight	22.260 kg
Calibration	Data
Calibration Zero Counts	1383
Linearity Adjust	Disabled
Load 1 Test Weight	30 kg
Load 1 Span Counts	881789
Load 2 Test Weight	
Load 2 Span Counts	
Load 3 Test Weight	
Load 3 Span Counts	
Load 4 Test Weight	
Load 4 Span Counts	
Last Calibration Method	Test Weight
Geo Code	16
mV/V Jumper	3mv/V

Home

Figure 5-23: Scale Data Page

## 5.10.4. Diagnostics & Maintenance Pages

### 5.10.4.1. Service Alerts

The Service Alert page shows the service icon status at the top of the page. This will be either OK (if the service icon is not currently active) or show  (if the service icon is active).

Below that, the most recent 5 events that triggered the Service Icon will be displayed. Each record includes time and date information, the error code (if an error code was assigned) and a text description of the event. These records are the same as the records shown on the Service Info Recall view on the terminal (refer to section 5.10.2, **Service Icon**).

The RESET button at the bottom of the Service Alert page manually resets or clears the Service Icon from the terminal display.

- If security is enabled, a maintenance level security login (or higher) is required to perform the reset.

### 5.10.4.2. Log File

The Log File page offers views of each of the four log files available in the IND570. Approximately 8 records can be displayed at one time. Scroll through all of the records in each log using a mouse and/or keyboard navigation keys.

## IND570 ?

### Diagnostics & Maintenance / Log Files

#### Change Log

Timestamp	Username	SDName	New Value
2012/09/10 16:18:51	MOORMAN	cm0103	12
2012/09/12 15:23:44	MOORMAN	pl0108	Test
2012/09/13 09:26:30	JOCEFOWICZ	sk0105	1
2012/09/13 08:58:13	COBURN	cs0114	3
2012/09/10 16:18:51	MOORMAN	cm0103	12
2012/09/12 15:23:44	MOORMAN	pl0108	Test
2012/09/13 09:26:30	JOCEFOWICZ	sk0105	1
2012/09/13 08:58:13	COBURN	cs0114	3

#### Error Log

Timestamp	Severity	Error	Detail	Message
2012/09/10 16:18:51	E	B0012E		Scale over capacity
2012/09/12 15:23:44	C	L03703		Load cell 37 RAM error
2012/09/13 09:26:30	I	A00100	0005	IDNet no communication
2012/09/13 08:58:13	I	A00100		IDNet no communication
2012/09/10 16:18:51	C	L03603		Load cell 36 RAM error
2012/09/12 15:23:44	E	B0012E		Scale over capacity
2012/09/13 09:26:30	C	L03703		Load cell 37 RAM error
2012/09/13 08:58:13	E	B0012E		Scale over capacity

#### GWP Log

Timestamp	User ID	GWP Test	Warning Status	Test Status
2012/09/10 16:18:51	MOORMAN	CALIBRATION	FAILED	FAILED
2012/09/12 15:23:44	MOORMAN	SENSITIVITY	PASSED	PASSED
2012/09/13 09:26:30	JOCEFOWICZ	REPEATABILITY	FAILED	PASSED
2012/09/13 08:58:13	COBURN	ECCENTRICITY	FAILED	FAILED
2012/09/10 16:18:51	MOORMAN	CALIBRATION	FAILED	FAILED
2012/09/12 15:23:44	MOORMAN	SENSITIVITY	PASSED	PASSED
2012/09/13 09:26:30	JOCEFOWICZ	REPEATABILITY	FAILED	PASSED
2012/09/13 08:58:13	COBURN	ECCENTRICITY	FAILED	FAILED

#### Maintenance Log

Timestamp	Username	Event	Status
2012/09/10 16:18:51	MOORMAN	9	Success
2012/09/12 15:23:44	MOORMAN	18	Success
2012/09/13 09:26:30	JOCEFOWICZ	3	Motion
2012/09/13 08:58:13	COBURN	3	Success
2012/09/10 16:18:51	MOORMAN	9	Success
2012/09/12 15:23:44	MOORMAN	18	Success
2012/09/13 09:26:30	JOCEFOWICZ	3	Motion
2012/09/13 08:58:13	COBURN	3	Success

Figure 5-24: Log File Page

### 5.10.4.3. Shared Data

The shared data page (Figure 5-36) allows the user to request a display of current values for up to ten shared data variables at a time. Values are accessed by entering the shared data name in one of the fields at left. When the **Save Changes** button at bottom is clicked, the Name fields are saved and the Values refreshed. The button is in focus when a new entry has been made in a Name field.

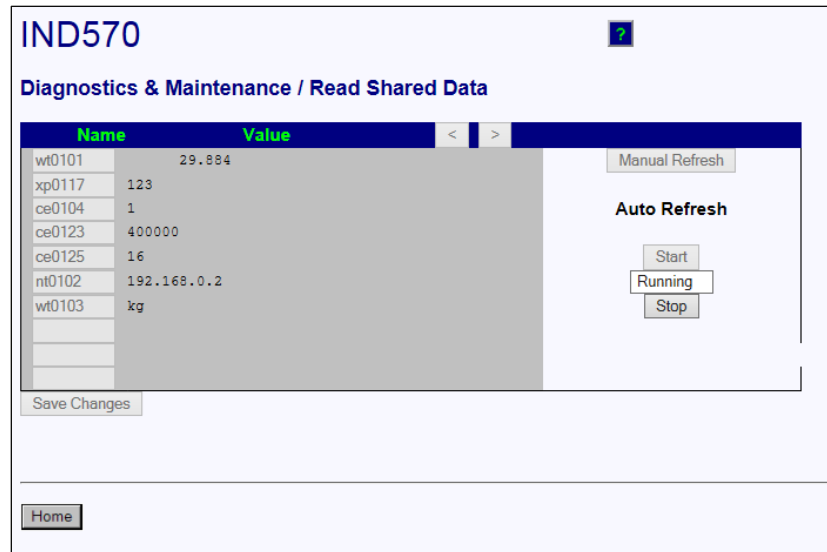

**Figure 5-25: Read Shared Data Page**

To refresh the displayed values without changing any variable names, click on the Manual Refresh button.

Values may also be refreshed automatically, at one second intervals, by clicking on the Start button. Once Start is selected, the Stop button is in focus and can be clicked. The current status of this dynamic display (Stopped or Running) is shown in a field between the two buttons. Note that, as indicated on the page, Auto Refresh must be stopped before new shared data names can be entered.

If a viewed string is longer than the data display width of 40 characters, the left/right scroll buttons at the top of the view box  can be used to move through the string to view all of it.

For a complete list of available shared data names, refer to the **IND570 Shared Data Reference** (30205337). In the example shown in Figure 5-36, the shared data information displayed is as follows.

**Table 5-17: Shared Data Information**

Name	Data Displayed	Interpretation
wt0101	29.2	Current gross weight value
xp0117	5585	Cumulative power on time, in minutes
ce0104	1	Number of ranges defined for the scale
ce0123	400000	Encoder counts at the middle calibration value for the scale

Name	Data Displayed	Interpretation
ce0125	16	GEO code set in the Scale calibration page
nt0102	172.18.49.120	Ethernet IP Address
wt0103	kg	Primary units set in the scale calibration page

#### 5.10.4.4. Write Shared Data

To access the Write Shared Data page, login at the administrator level is required. When prompted, enter the administrator's user name and password.

Figure 5-26: Write Shared Data Page

Enter the Shared Data variable name in the **Name** column at left, and the value to be written to it in the **Value** column. Click the **Write** button. Four Shared Data variables can be modified at a time.

#### 5.10.4.5. Reset Terminal

From this screen, the terminal can be restarted (equivalent to cycling power) or reset to factory defaults (except for scale settings, scale calibration settings, tables and log files).

- When a Reset is performed, the Terminal's IP address will default to factory settings.
- If user security is enabled, access to the Reset Terminal page requires a login at the administrator level. When prompted, enter the administrator's user name and password.

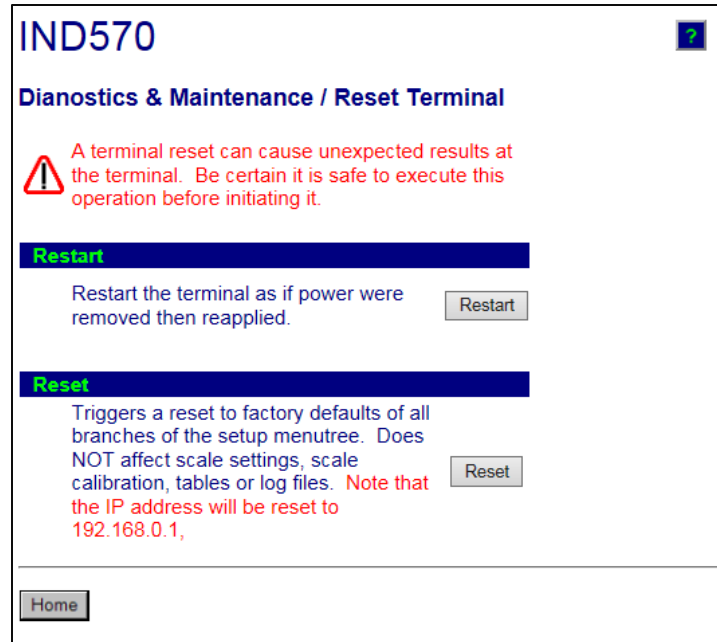

Figure 5-27: Reset Terminal Page

## 5.11. Web Server – POWERCELL

The POWERCELL version of the IND570 includes some changes in the Web Server Interface from the analog/IDNet/SICSpro version.

### 5.11.1. Home Page

When the POWERCELL Web Server is first accessed, the Home page shown in Figure 5-39 appears in the browser window.



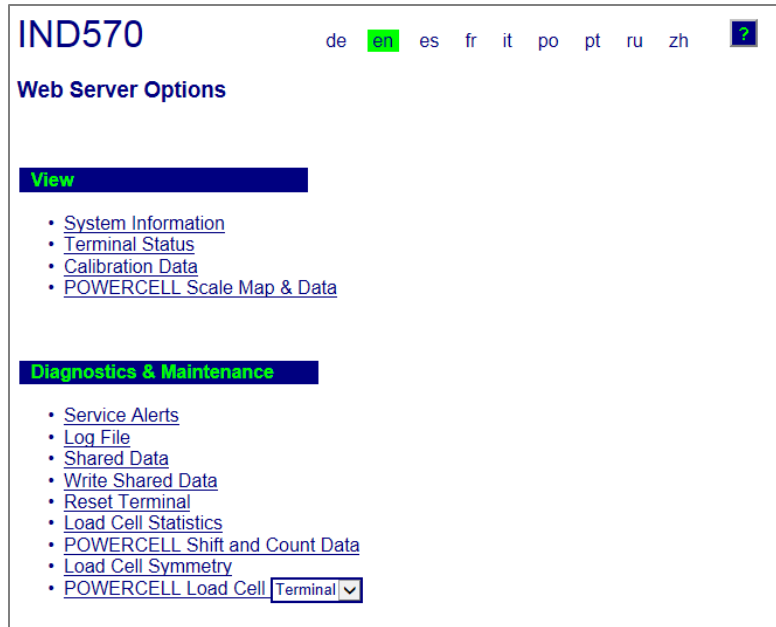

**Figure 5-28: Web Server Home Screen**

Click the links on this page to visit the respective views, each of which is detailed in the following sections.

At the bottom of each page accessed, a HOME button is shown which returns the view to the Home page seen in Figure 5-39 when pressed.

### **5.11.2. Help File**

A help file, accessible from each page via the help button  explains the full range of the utility's features. Refer to this file for a full explanation of each of the data and utilities available on each page. Figure 5-30 shows a portion of the help file.

At the bottom of the Help page, a  button allows the user to close this second browser window without exiting the Web Server utility.

### **5.11.3. View Pages**

#### **5.11.3.1. System Information**

The POWERCELL system information page is the same as the analog/IDNet/SICSpro version. Refer to Figure 5-31 for details.

#### **5.11.3.2. Terminal Status**

The Terminal Status page (Figure 5-40) gives a snapshot of the current status of the terminal, including power on time, statistics, peak weights and information about the various types of memory used by the IND570.

# IND570



## View / Terminal Status

Voltages	Calibration	Current	
Battery	3.1 V	3.1 V	OK
Supply voltage	24.3 V	24.2 V	OK

Power On	
Total power on time:	54.49 days
Time since last power on:	1.05 days
Time above 1% load:	46.23 days
Power on cycles:	40
Usage time	84.85%
Usage Cycles / Day	1
Transactions / Day	8
Total Transactions	243
Total Weight	10515180 lb

Peak Loading		Last Date
Total Peak Weight	1600000 lb	18/Jan/2017
Average Peak Load	53.666667%	

Statistics		Last Date
Last Reset	15/Feb/2017	
Platform Underloads	0	---
Platform Overloads	2	18/Jan/2017
Zero Commands	4	
Zero Command Failures	1	15/Dec/2016
Zero Command Failures (%)	25%	
Zero Drift Errors	0	---
Symmetry Errors	0	---
Cell Overload Errors	0	---
Maximum Cell Overload	OK	
Cell Temperature Errors	OK	0

Memory	Used / Capacity
Flash Memory	7.28MB/7.38MB
Battery Backed RAM	0.75MB/0.76MB
Dynamic RAM	6.25MB/6.25MB
USB Memory	---

### Reset Statistics

Reset the data of Statistics.

Reset

Home

Figure 5-29: Terminal Status Page

### 5.11.3.3. Calibration Data

The Calibration Data page (Figure 5-41) is very similar to the Scale Data page of the analog/IDNet/SICSpro version. This page shows information, including current configuration and calibration values, for the scale. The signal quality display permits troubleshooting of the connection between the IND570 and load cells. A summary of the Calibration and GWP expiration information is added at the bottom of the page.

## IND570 ?

**View / Calibration Data**

Capacity	Data
Scale Type	POWERCELL
Number of Ranges / Intervals	2 Intervals
> 1 < Capacity	300 kg
> 1 < Increment	0.1 kg
> 1 < Display Increments	3000
> 2 < Capacity	600 kg
> 2 < Increment	0.2 kg
> 2 < Display Increments	3000
> 3 < Capacity	
> 3 < Increment	
> 3 < Display Increments	

Performance	Data
Counts / Display Increment	94
Signal Quality	<span style="background-color: #00FF00; border: 1px solid black; border-radius: 50%; padding: 2px 5px;">OK</span>
Current Counts	254320
Last Zero Counts	72311
Adjusted Counts	182009
Current Weight	58.42 kg

Calibration	Data
Calibration Zero Counts	73202
Linearity Adjust	3 Points
Load 1 Test Weight	20 kg
Load 1 Span Counts	142341
Load 2 Test Weight	50 kg
Load 2 Span Counts	246049
Load 3 Test Weight	
Load 3 Span Counts	
Load 4 Test Weight	
Load 4 Span Counts	
Last Calibration Method	Test Weight
Geo Code	16
mV/V Jumper	3mV/V

Cal & GWP Expiration	Date	Transactions
Calibration	7-21-2016	425
Sensitivity	7-21-2016	358
Eccentricity	7-21-2016	285
Repeatability	7-21-2016	285

Home

Figure 5-30: Calibration Data Page

### 5.11.3.4. POWERCELL Scale Map & Data

The View POWERCELL Scale Map & Data page (Figure 5-42) shows load cell information for an installed POWERCELL scale. The graphic representing the scale platform will be either round (number of POWERCELLs is 1, 3, 5 or 7) or rectangular as shown for number of POWERCELLs 2, 4, 6, and 8 or more. This page provides access to several views, accessible from the drop-down list at upper left:

- Adjusted Counts
- Temperature (MT Service only)
- Gross Weight
- Input Voltage (MT Service only)
- Communication Errors
- Gas Concentration (MT Service Only)

■ As indicated in the list above, some views are accessible only if the terminal's MT Service Security has been unlocked.

On the web pages each cell node is represented by a circle, with different colors to indicate if certain fault conditions exists. A circle with a red border (as node 7 in the example below) indicates that a fault condition has been detected, but in a different view. A completely solid red circle indicates that a fault is present in the current view.

Indicated fault conditions include cell communication errors and enclosure breaches. Click on a cell to go to its detailed (POWERCELL Load Cell) page.

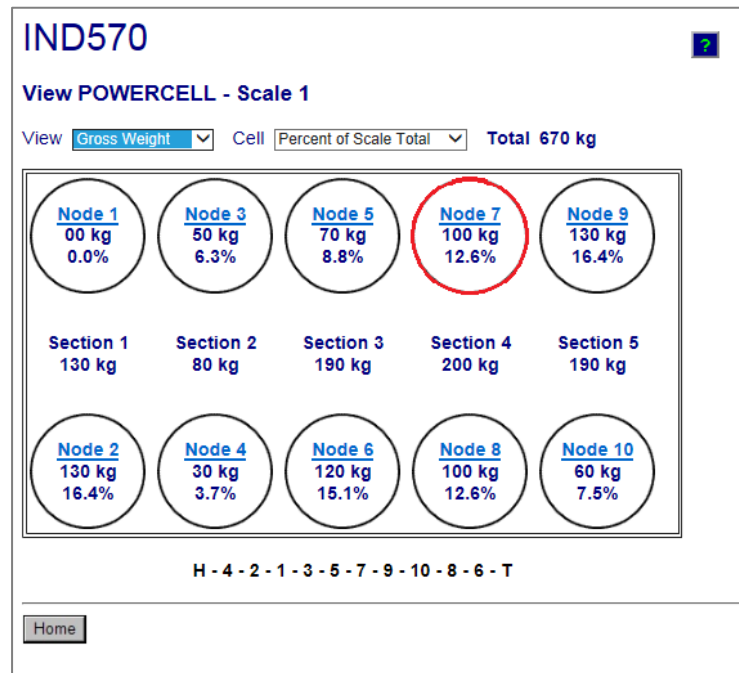

Figure 5-31: POWERCELL Scale Map and Data Page

If POWERCELL Scale mapping information has been populated correctly in the terminal, the sequence of the nodes shown will match the exact load cell layout of the platform. In addition, the string of characters under the graphic shows the connection sequence of load cells in the network. The sequence starts with HR (Homerun cable) then shows each node number in sequence of

network cable connection and ending with T (termination). This diagram will aid in diagnosing connectivity problems in the network.

#### 5.11.4. Diagnostics & Maintenance Pages

##### 5.11.4.1. Service Alerts

The Service Alert page for the POWERCELL version is the same as for the analog, IDNet and SICSpro version.

##### 5.11.4.2. Log File

The Log File page for the POWERCELL version is the same as for the analog, IDNet and SICSpro version. Refer to Figure 5-35.

##### 5.11.4.3. Shared Data

The shared data page (Figure 5-36) for the POWERCELL version is the same as for the analog, IDNet and SICSpro version.

##### 5.11.4.4. Write Shared Data

The Write Shared Data page for the POWERCELL version is the same as for the analog, IDNet and SICSpro version. Refer to Figure 5-37.

##### 5.11.4.5. Reset Terminal

The Reset Terminal page for the POWERCELL version is the same as for the analog, IDNet and SICSpro version. Refer to Figure 5-38.

##### 5.11.4.6. POWERCELL Statistics

The POWERCELL Statistics page shows, for each cell in the network, the number of cell overloads, the number of temperature errors, the number of zero drift errors, the number of symmetry span errors, the number of communication errors and the maximum cell overload value. In addition, it shows the date of the most recent occurrence for each of these items. Dashes indicate no data for that cell.

IND570 <span style="float: right;">?</span>											
Diagnostics & Maintenance / POWERCELL Statistics											
Node	Cell Overloads		Temperature Errors		Maximum Cell Overload		Zero Drift Errors		Symmetry Span Errors		Communication Errors
	Qty	Date	Qty	Date	Value	Date	Qty	Date	Qty	Date	
1	0		2	Feb 16 2016	--		6	Jan 30 2016	0		4
2	0		0		--		0		0		4
3	0		0		--		0		0		4
4	2	Feb 5 2016	0		139%	Jan 21 2016	0		0		24
5	1	Mar 1 2017	0		125%	Mar 1 2017	0		0		23
6	0		0		--		0		0		23
7	0		0		--		0		0		25
8	0		0		--		0		0		23

[Home](#)

Figure 5-32: POWERCELL Statistics

### 5.11.4.7. POWERCELL Shift and Count Data

The POWERCELL Shift and Count Data page shows the shift adjust value, calibrated zero counts, last zero counts, high calibration counts, live counts and adjusted live counts for all cells in the network. Cell and scale errors are also shown on this page. Refer to Figure 5-44 for an example.

Cell No.	Cell Addr.	Shift Adjust	Calib. Zero	Last Zero	Calib. High	Live Load	Adj. Live	Cell Error	Scale Error
1	1	1.000172	11607	11414	39693	11415	1		
2	2	1.000172	8826	9121	42169	9120	-1		
3	3	0.997361	20009	20328	43540	20331	3		
4	4	0.997361	19275	19074	47757	19075	1		
5	5	1.004074	18492	18827	18484	18825	-2		
6	6	1.004074	20855	20679	20641	20676	-3		
7	7	0.998243	11651	11440	11636	11443	3		
8	8	0.998243	9389	9731	9405	9732	1		
Calib. Wt. =					24980 lb	Actual Wt. =		00 lb	

Figure 5-33: POWERCELL Shift and Count Data

### 5.11.4.8. Load Cell Symmetry

The Load Cell Symmetry page for the POWERCELL version shows the variance between the stored symmetry values and the actual values. The variance is shown as a percentage of the weight applied. Refer to Figure 5-45 for an example of this page. In this example, symmetry checking is disabled so no difference values are listed.

Node	% Difference
01	
02	
03	
04	
05	
06	
07	
08	

Figure 5-34: Load Cell Symmetry

### 5.11.4.9. POWERCELL Load Cell

The POWERCELL Load Cell page can be chosen to show specific data from either the terminal or from any of the load cells. The view can be switched by making a different selection in the drop down box in the upper right of the display. Much of the data here can only be seen only if the terminal's MT Service Security has been unlocked. An example "unlocked" terminal view is shown in Figure 5-46 and an example "unlocked" load cell view is shown in Figure 5-47.

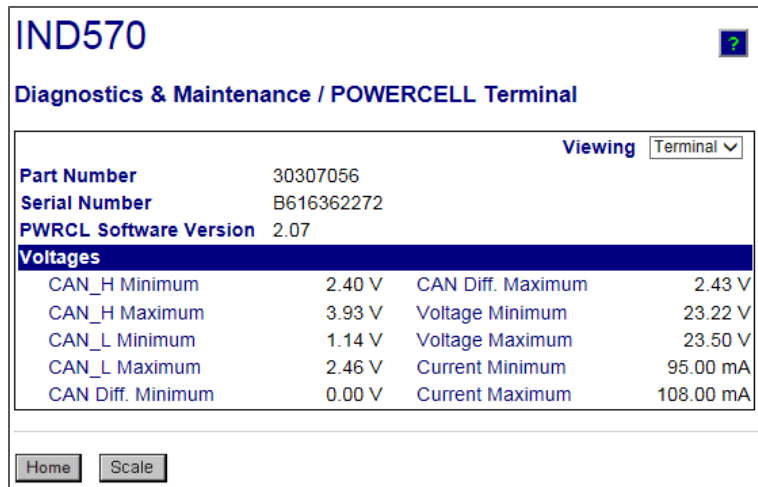

Figure 5-35: POWERCELL Terminal Data

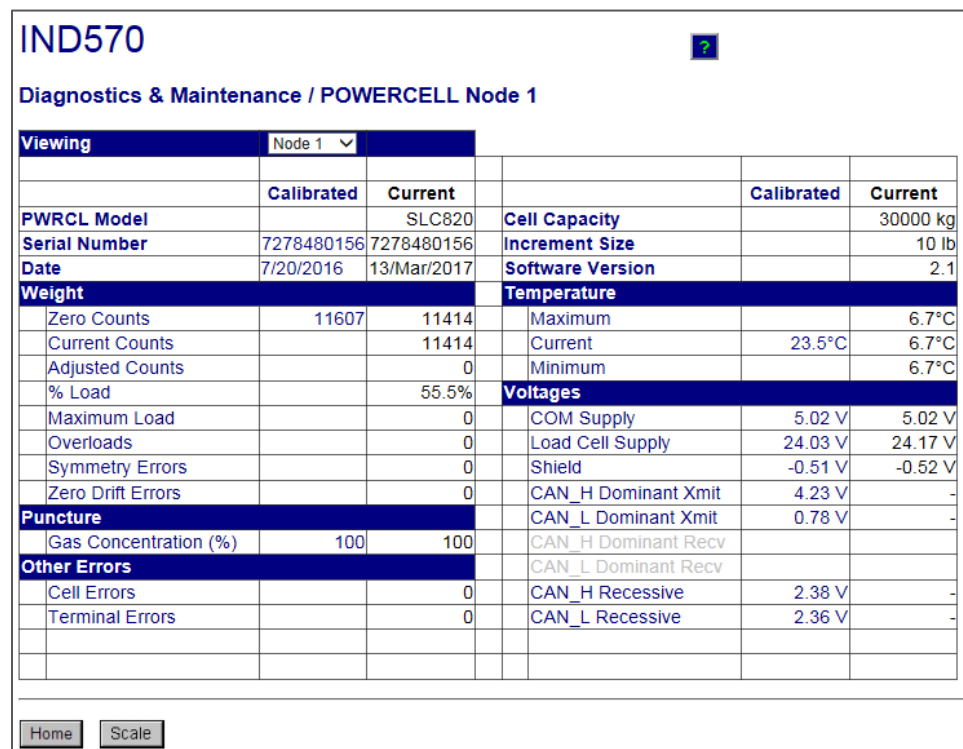

Figure 5-36: POWERCELL Load Cell Data



## 5.12. Master Reset

A master reset function is provided to allow reset of all IND570 terminal settings to the factory default settings (refer to Appendix A, **Default Settings**).

The master reset typically is performed under these circumstances:

- When a software configuration problem arises that cannot be resolved without starting from the factory default settings.
- When user security is enabled to protect unauthorized access or use, and the “admin” account password is lost.
- After an application hardware key (I-button) is installed or removed.
- After a firmware upgrade is performed (recommended).NOTE: Ensure that terminal configuration and calibration is backed up to a USB memory device before performing a Master Reset. This data can be reloaded into the terminal after the Master Reset is complete.

### 5.12.1. To initiate a master reset

1. Remove AC or DC power from the terminal.
2. Place both switches SW1-1 and SW1-2 in the ON position, as shown in Figure 5-48.

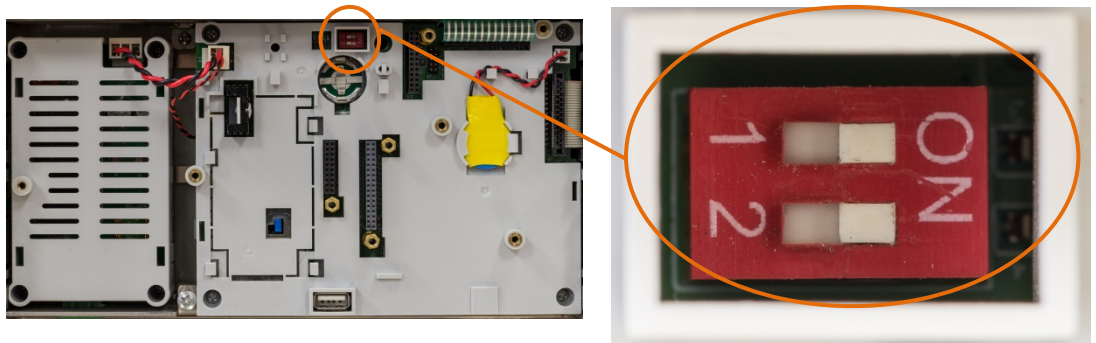

Figure 5-37: Metrology Switch Location

- If a reset of calibration data is also required, set SW2-1 to ON. The position of SW2-1 (indicated in Figure 5-49) determines whether metrologically significant EEPROM (scale, calibration) data is reset when a master reset is performed. If SW2-1 is set to OFF, EEPROM data will **not** be affected by the master reset.

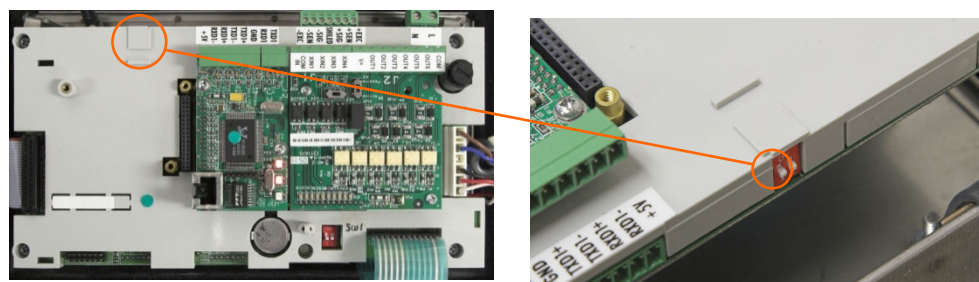

Figure 5-38: Location of Switch SW2-1

3. Apply AC or DC power. During the power up sequence, the display will indicate a warning message "WARNING! Master Reset ALL setup blocks. Continue?"
4. Press ENTER to perform a master reset and return all settings to factory defaults. This initiates a power cycle and returns the terminal to the home screen.
  - To cancel and exit without carrying out a master reset, do not press ENTER. Remove power. Return SW1-1 and SW1-2 (and SW2-1 if needed) to their original positions. Reapply AC or DC power.
5. Return SW1-1 and SW1-2 (and SW2-1 if needed) to the OFF positions.

## 5.13. InTouch<sup>SM</sup>

### 5.13.1. InTouch Installation in IND570

#### 5.13.1.1. Introduction

Almost all required InTouch settings must be configured using InSite CSL. The InTouch activation process includes configuration of settings only available through InSite CSL, installation of the InTouch.xml configuration file into the terminal, and finally enabling the InTouch agent within terminal setup.

If configuring an IND570 for the first time, it makes good sense to do the complete configuration of the terminal using InSite CSL. This full configuration, including the InTouch setup, can be saved to a USB memory stick and easily transferred to an IND570. Alternatively, the full configuration can be completed through a live connection with InSite CSL to an IND570 terminal.

	<b>WARNING</b>
<b>THE USB INTERFACE IS NOT CERTIFIED FOR USE IN DIVISION 2 OR ZONE 2/22 HAZARDOUS AREAS. USE ONLY IN SAFE AREA.</b>	

#### 5.13.1.2. InTouch in InSite CSL

After the non-InTouch functions of a terminal are complete, click on the Options tab of InSite CSL to find the InTouch icon (Figure 5-50). Select the InTouch icon and note the tasks panel at left. Two very important configuration areas are InTouch and IND570 Network Settings.

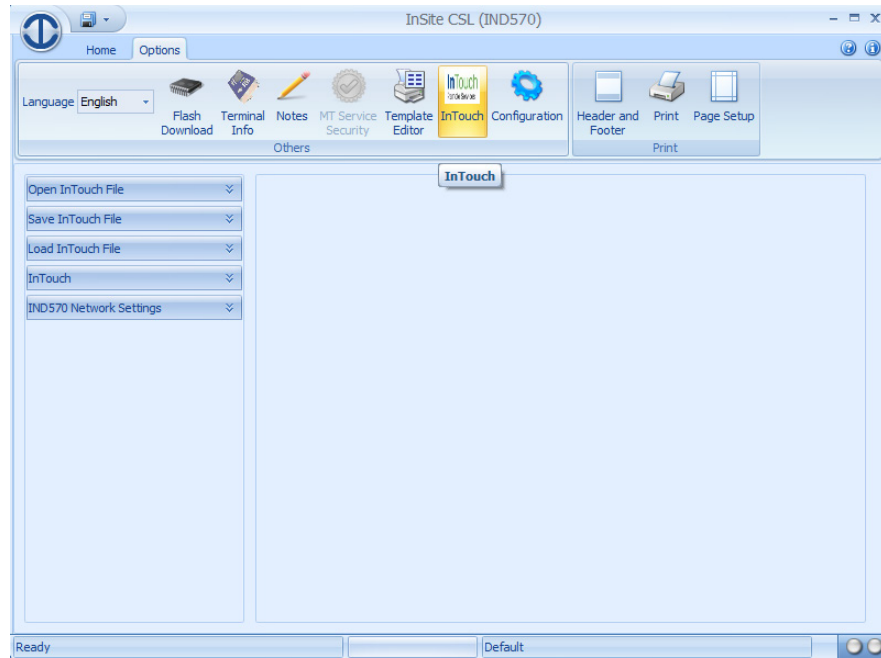

**Figure 5-39: InSite CSL Options Tab**

### **5.13.1.3. Network Settings**

First, select IND570 Network Settings (Figure 5-51). If these general network settings have not yet been configured, here you can also configure the Ethernet port security access and network as you normally would with InSite or by using the terminal front panel. InTouch setup in InSite has two very important categories: Network - DNS Server and Network - Proxy Server (Figure 5-51 and Figure 5-52). The information required for these two settings must be obtained from the customer's IT department. Your sales representative should have completed the InTouch Pre-installation Questionnaire with the customer, and this data can be found on that worksheet. Enter this data after it is received from the customer.

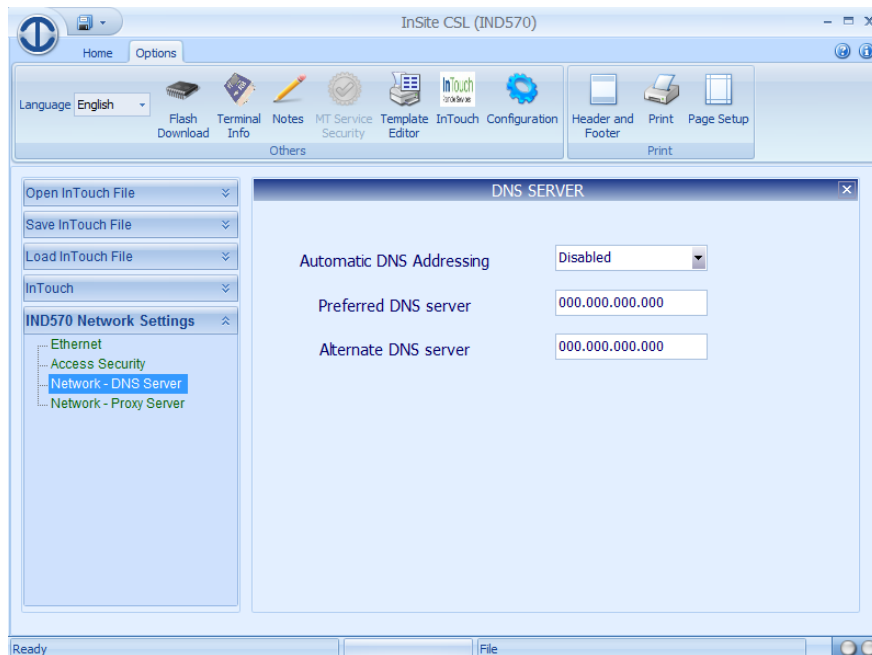

Figure 5-40: DNS Server Settings

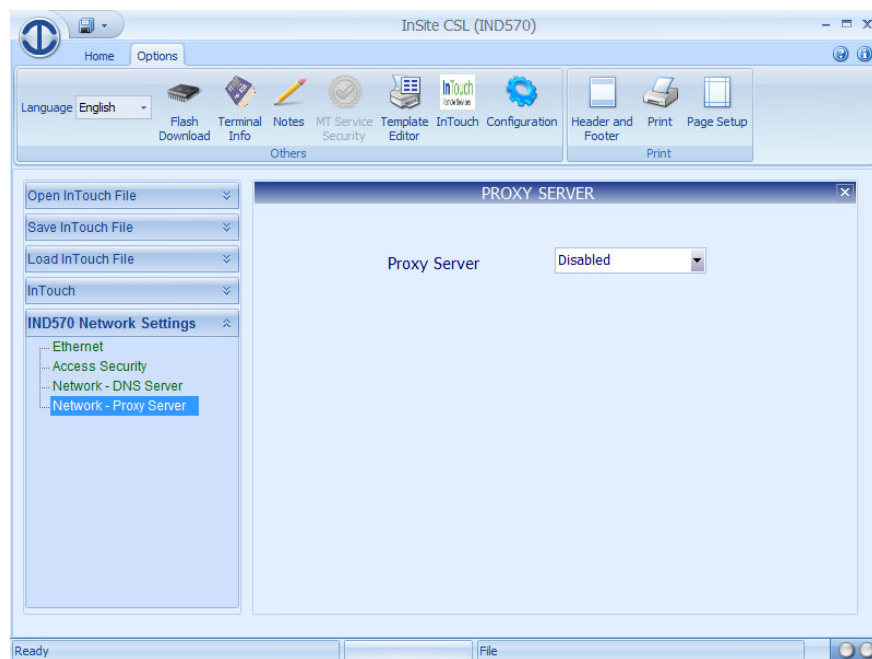

Figure 5-41: Proxy Service Settings

## 5.13.2. InTouch Configuration

### 5.13.2.1. Configuring the InTouch Agent in IND570

Next, select the InTouch branch. The InTouch configuration screen provides access to the InTouch agent program inside the IND570 (Figure 5-53). These settings are not available through the terminal's front panel. The terminal must be identified by its serial number. After that, make the following settings:

<b>InTouch Server</b>	Select the Production server.
<b>Region</b>	Set to region of Remote Service coverage, for example, MT MOUS for North America.
<b>Customer ID</b>	The customer ID is the same ID provided in the job ticket – i.e. the customer ID assigned by SAP

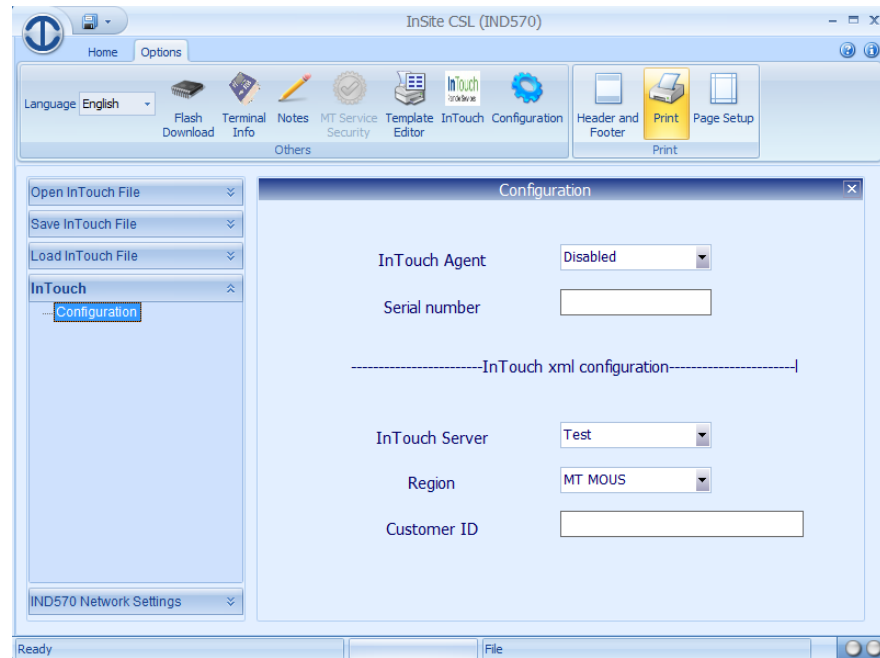
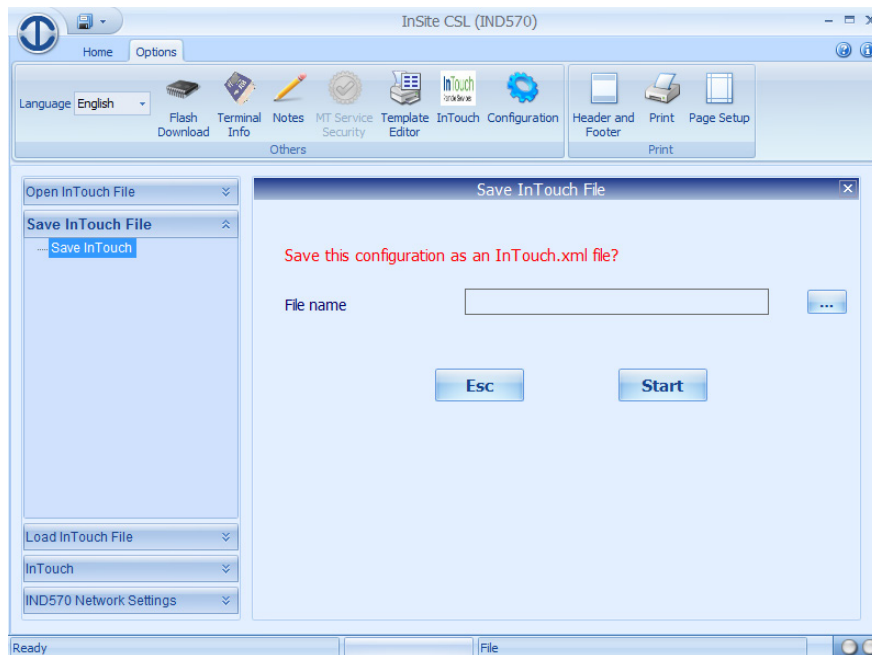

**Figure 5-42: InTouch Configuration Screen**

### 5.13.2.2. Loading the InTouch File into the Terminal

The InTouch file can be loaded directly into the IND570 through a direct connection with InSite or via the Restore from USB function. The following example guides a service provider through the Restore from USB file transfer.

1. Click on Save InTouch File (refer to the left pane of the InSite CSL screen in Figure 5-53. The screen shown in Figure 5-54 will display.



**Figure 5-43: Selecting a File Name**

- It is not possible to enter a file name here. Instead, press the browse button (...) to open the save window similar to the one shown in Figure 5-55. Navigate to the appropriate file location on the USB drive

\\IND570\Terminal Serial #\Config\InTouch.xml

and type InTouch in the File name field. Click Save to save the file.

- Note that putting the filename in the root of the USB memory stick will not work. As in the backup and restore functions of the IND570, there is a defined directory structure on the USB memory stick. Refer to section 5.4.1.1 for details.

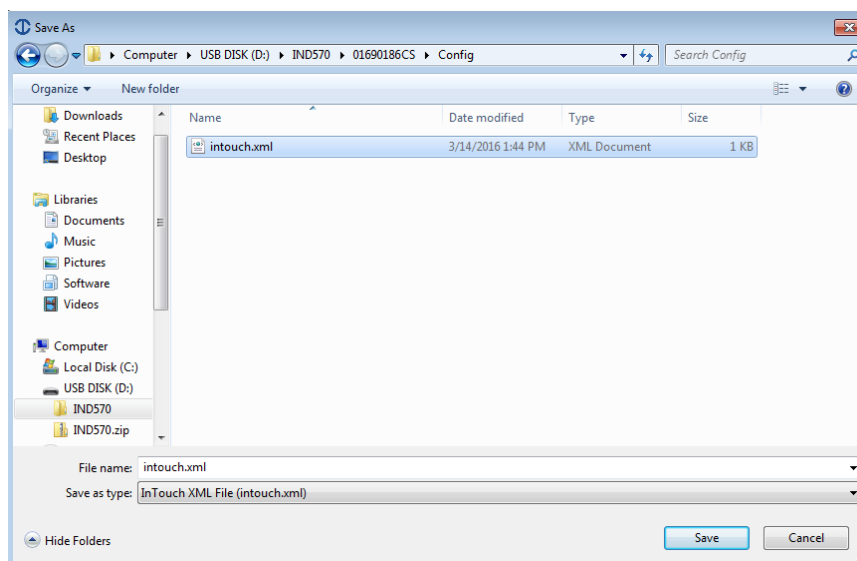

**Figure 5-44: Saving the InTouch File**

- If additional terminal configuration of non-InTouch functions has also been completed in InSite, you must also save the terminal configuration file. This is separate from the InTouch.xml file. Click on the Home tab of InSite CSL. Click on Save and select Save to USB. Click on the IND570 main folder and click OK (Figure 5-56). The full terminal configuration, including the InTouch.xml file, and now saved to the USB memory drive under the specific terminal serial # folder.

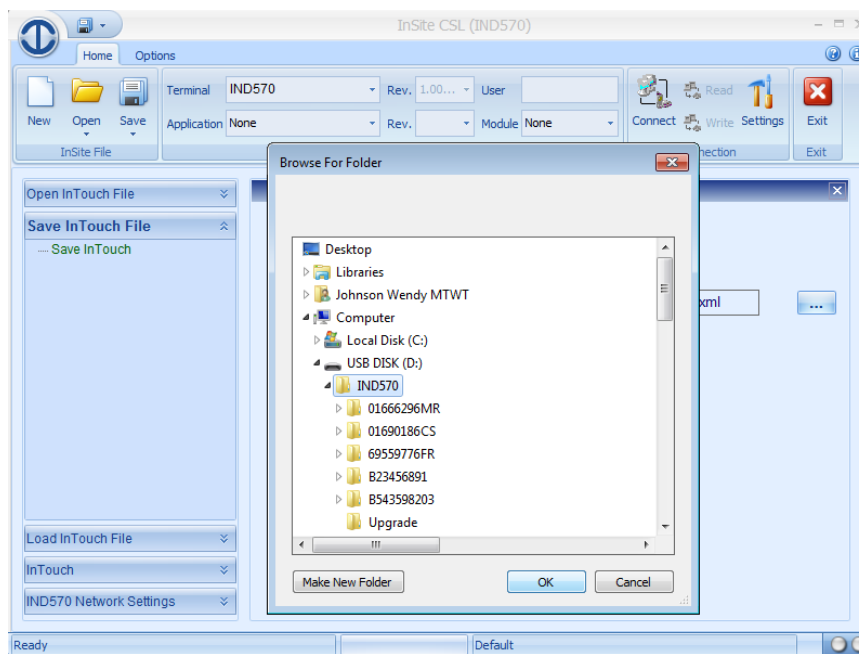

**Figure 5-45: Saving the InSite Configuration File to USB**

- Insert the USB memory stick into the IND570 USB port. Enter Setup and navigate to **Maintenance > Run > Restore** from USB.
- Select Configuration and press the START softkey.

Transferring the InTouch.xml file from the USB stick does not automatically enable InTouch. To enable the InTouch agent, access **Setup > Maintenance > InTouch**.

On the InTouch screen, set the InTouch Agent to Enabled.

InTouch is now installed, configured and active. To confirm connectivity with the InTouch Enterprise Server, on the home screen press the INFORMATION RECALL  softkey to access the recall screen. The data line on the Recall display will provide the current status of the InTouch agent.



Figure 5-46: Information Recall View

## 5.14. Proactive Alarming and Alerting

IND570 provides many methods for proactively alerting both a local operator of the equipment as well as a remote maintenance group or service provider that the IND570 is in an error condition or requires attention. These proactive alerting measures include:

- Email messages
- Activation of the Service Icon
- System Alarm discrete output
- InTouch events and alarms

Information regarding setup of each of these functions can be found throughout the IND570 **Technical Manual**. Section 5.16.5 provides a summary of which proactive alarming and alerting actions are initiated when certain conditions occur in the IND570.

### 5.14.1. Email Alerts

Details on the automatic and manual email functions are listed in Section 2.9.5. Email configuration guidelines are documented in Section 3.8.8.5.

### 5.14.2. Service Icon

Please refer to Sections 2.9.4 and 3.9.2.3.9 for details regarding function and reset of the Service Icon.

### 5.14.3. System Alarm and System OK Discrete Outputs

The System OK discrete output remains in the "ON" condition unless the IND570 is forced into an "Invalid Weight" state. Invalid Weight conditions also set the System Error Alarm to "ON".

If the System Error Alarm output is "ON", the System OK output will always be in an "OFF" state. There are no situations where both outputs will be found in the same ON or OFF condition.

### 5.14.4. InTouch Remote Services

Details on InTouch remote services are provided in Sections 2.9.6 and 5.15.



#### **5.14.5. System Conditions that Trigger a Proactive Alarm/Alert**

Table 5-19 summarizes the system conditions that will trigger a proactive alarm or alert function in the IND570, and identifies the type(s) of alarm or alert that is activated.

**Table 5-18: System Conditions that Trigger a Proactive Alarm/Alert**

Codes for E-mail and InTouch :

A	Alarm	I	Information	F	Fatal
E	Event	W	Warning	S	Service

IND570 Error/Event Code	Error Log Record (Y/N)	Service Icon (Y/N)	System Alarm Discrete Output (Y/N)	Email (Y/N - Category)	InTouch (Y/N -Category)	Displayed or Recorded Error/Event Message	Comment(s)
A00*2D	Y	N	N	Y - I	Y - E	POWERCELL node * temperature difference warning	
A00*2E	Y	Y	N	Y - W	Y - A	POWERCELL node * severe temperature difference	
A00006	N	N	Y	Y - W	Y - E	Scale blanked over capacity	
A00007	N	N	N	N	Y - E	Scale under zero (weight value)	
A00013	N	N	N	Y - W	N	Zero failed - Range	
A00023	N	N	N	Y - I	Y - E	Maximum peak weight updated	
A00024	Y	N	Y	Y - W	Y - E	Power-up zero not captured	
A00025	Y	Y	Y	Y - F	Y - A	Low excitation voltage	Occurs when excitation voltage measures less than 9.0V
A00026	Y	N	N	N	N	Potential analog section saturation. Recalibrate with new capacity.	
A00030	N	N	N	N	N	Data checksum error. Please try again.	Data from the platform is corrupt, while in ASM (Advanced Setup Mode).
B00001	Y	N	Y	N	N	Zero required	Zero function for R51 MID approval has timed out
D00001	Y	Y	Y	Y - W	Y - A	D00101: Remote 1.0.x Error D00201: Remote 2.0.x Error D00301: Remote 3.0.x Error	Indicates a communication issue with ARM100 modules
E00001	Y	Y	N	Y - F	Y - A	Battery voltage extremely low	
E00002	Y	N	N	Y - W	Y - E	Battery voltage low	
E00003	N	N	N	Y - W	N	System error alarm triggered	
E00004	N	N	N	Y - I	Y - E	Battery replaced	
E00005	Y	N	N	N	N	Internal Flash error	
I00001	Y	N	Y	Y - W	Y - A	File open error	Occurs when TaskExpert file fails to execute

IND570 Error/Event Code	Error Log Record (Y/N)	Service Icon (Y/N)	System Alarm Discrete Output (Y/N)	Email (Y/N - Category)	InTouch (Y/N -Category)	Displayed or Recorded Error/Event Message	Comment(s)
I00006	Y	N	N	N	N	No line number	TaskExpert error
I00007	Y	N	N	N	N	Record not found	TaskExpert error
I00008	Y	N	N	N	N	RETURN without GOSUB	TaskExpert error
I00009	Y	N	N	N	N	Incomplete Statement	TaskExpert error
I0000A	Y	N	N	N	N	ON without GOTO or GOSUB	TaskExpert error
I0000B	Y	N	N	N	N	Value Out of Range	TaskExpert error
I0000C	Y	N	N	N	N	Syntax Error	TaskExpert error
I0000D	Y	N	N	N	N	Invalid Device Number	TaskExpert error
I0000E	Y	N	N	N	N	Device Error	TaskExpert error
I0000F	Y	N	N	N	N	Error in operating system command.	TaskExpert error
I00010	Y	N	N	N	N	Argument must be a string	TaskExpert error
I00011	Y	N	N	N	N	Bad event definition	TaskExpert error
I00012	Y	N	N	N	N	Type mismatch	TaskExpert error
I00013	Y	N	N	N	N	Argument is not an array name	TaskExpert error
I00014	Y	N	N	N	N	Out of data	TaskExpert error
I00015	Y	N	N	N	N	Overflow	TaskExpert error
I00016	Y	N	N	N	N	Improper FOR-NEXT	TaskExpert error
I00017	Y	N	N	N	N	Undefined function	TaskExpert error
I00018	Y	N	N	N	N	Divide by zero	TaskExpert error
I00019	Y	N	N	N	N	Cannot redimension variable	TaskExpert error
I0001A	Y	N	N	N	N	Error DIM command	TaskExpert error
I0001B	Y	N	N	N	N	Illegal command	TaskExpert error
I0001C	Y	N	N	N	N	Variable has too many dimensions	TaskExpert error
I0001D	Y	N	N	N	N	Invalid Shared Data name	TaskExpert error
I0001E	Y	N	N	N	N	Program too big	TaskExpert error
I0001F	Y	N	N	N	N	Line too big	TaskExpert error
I00020	Y	N	N	N	N	Shared data string too long	TaskExpert error
I00021	Y	N	N	N	N	No access to remote	TaskExpert error
I00022	Y	N	N	N	N	UNICODE conversion error	TaskExpert error

IND570 Error/Event Code	Error Log Record (Y/N)	Service Icon (Y/N)	System Alarm Discrete Output (Y/N)	Email (Y/N - Category)	InTouch (Y/N -Category)	Displayed or Recorded Error/Event Message	Comment(s)
I00024	Y	N	N	N	N	Database already in use	TaskExpert error
I00025	Y	N	N	N	N	Database access error	TaskExpert error
I00026	Y	N	N	N	N	Bad table index	TaskExpert error
I00027	Y	N	N	N	N	Table command error	TaskExpert error
I00028	Y	N	N	N	N	Task Expert not authorized	TaskExpert error
I00029	Y	N	N	N	N	Custom application not authorized	TaskExpert error
I0002A	Y	N	N	N	N	Pac application not authorized	TaskExpert error
I0002B	Y	N	N	N	N	Main board switch 2 set	TaskExpert error
I0002C	Y	N	N	N	N	Application not authorized	TaskExpert error
L00*5B	Y	N	N	N	N	Node * no response.	
L00*5C	Y	N	N	N	N	Node * negative out of range	
L00*5F	Y	Y	N	Y - S	Y - A	POWERCELL node * enclosure break	
L00*78	Y	N	N	N	Y - E	POWERCELL node * initializing	
L00*79	Y	Y	Y	Y - F	Y - A	Node * not found	
L00*7A	Y	Y	N	Y - S	Y - E	POWERCELL node * gas monitor failure	
L00*81	Y	Y	N	Y - S	Y - E	LC Com Error - Run Flat	
L00*82	Y	Y	Y	Y - F	Y - A	Fatal symmetry error	
L00*83	Y	Y	Y	Y - F	Y - A	Fatal LC com error	
L00*85	Y	Y	Y	Y - F	Y - A	Fatal zero drift error	
L00024	Y	Y	N	Y - F	Y - E	Warning – Platform battery voltage very low	Displayed at system start-up, and every four hours, when two to seven days of Cable-Free Floor Scale platform battery life remain.
L00056	Y	N	Y	Y - S	Y - E	POWERCELL channel not found	
L00057	Y	Y	Y	Y - F	Y - A	POWERCELL board access error	
L00058	Y	N	N	N	Y - E	POWERCELL board response timeout	
L00059	Y	Y	N	Y - F	Y - E	POWERCELL board invalid protocol response	
L0005D	Y	Y	N	Y - S	Y - E	POWERCELL command failed	
L0005E	Y	N	N	N	N	POWERCELL CalFree cells don't match	
L00064	Y	N	N	Y - I	Y - E	POWERCELL board major overvoltage or overcurrent	

IND570 Error/Event Code	Error Log Record (Y/N)	Service Icon (Y/N)	System Alarm Discrete Output (Y/N)	Email (Y/N - Category)	InTouch (Y/N -Category)	Displayed or Recorded Error/Event Message	Comment(s)
L00065	Y	N	N	Y - I	Y - E	POWERCELL board major undervoltage	
L00076	Y	N	N	Y - I	Y - E	POWERCELL board minor overvoltage or overcurrent	
L00077	Y	N	N	Y - I	Y - E	POWERCELL board minor undervoltage	
L00080	Y	Y	N	Y - S	Y - E	Symmetry Error - Run Flat	
L00084	Y	Y	N	Y - S	Y - E	Zero drift - Run Flat	
L00087	Y	Y	Y	Y - W	Y - A	Connect IDNet base	Terminal does not detect an IDNet platform
L00088	Y	Y	Y	Y - W	Y - A	MELSI error	
L00089	Y	N	Y	Y - F	N	Excitation voltage below acceptable limit	Excitation voltage is measuring less than 5.0V
L00090	Y	Y	Y	Y - W	Y - A	No digital scale interface	Terminal does not detect that a digital scale interface is connected to the terminal main board
L00091	Y	Y	Y	Y - W	Y - A	Connect SICSpro scale	Terminal does not detect a SICSpro platform
L00092	N	Y	N	Y - W	Y - A	FACT failed - 3 consecutive failed attempts	
L00093	Y	Y	Y	Y - S	N	Load cell mismatch - scale disabled	
L00094	Y	Y	Y	Y - W	Y - A	Low supply voltage	
L00096	N	Y	N	Y - W	Y - E	Loading Alert	
L00097	Y	N	N	Y - W	Y - E	Platform battery low	Displayed at system start-up, and every day at 10 a.m., when approximately one month of Cable-Free Floor Scale platform battery life remains.
L00098	Y	N	N	Y - I	Y - E	PWRCL Network initializing	<b>POWERCELL version only</b>
L0009A	Y	Y	Y	Y - F	Y - A	Bluetooth error - IND570	The Bluetooth module attached to the IND570 is not communicating.
L0009B	Y	Y	Y	Y - F	Y - A	Bluetooth error- scale	The Bluetooth module in the scale base is not communicating.
L0009C	Y	Y	Y	Y - F	Y - A	Bluetooth OK - No scale data	The scale is not communicating data to its Bluetooth module
L0009D	N	N	N	N	N	Platform MAC is null	The scale platform has no MAC address.
L0009E	Y	Y	Y	N	Y - E	Invalid Weight Data	Shown if weight data from platform fails a checksum test 5 times.



IND570 Error/Event Code	Error Log Record (Y/N)	Service Icon (Y/N)	System Alarm Discrete Output (Y/N)	Email (Y/N - Category)	InTouch (Y/N -Category)	Displayed or Recorded Error/Event Message	Comment(s)
M00002	N	N	N	Y - I	Y - E	Zero Calibration complete	
M00003	N	N	N	Y - I	Y - E	Span Calibration complete	
M00004	N	N	N	Y - I	Y - E	CalFree Calibration successful	
M00012	N	N	N	Y - I	Y - E	Calibration values manually edited	
M00019	N	N	N	Y - I	N	Step Calibration complete	
M0001A	N	N	N	Y - I	Y - E	Calibration test passed	
M0001B	N	N	N	Y - I	Y - E	Sensitivity test passed	
M0001C	N	N	N	Y - I	Y - E	Eccentricity test passed	
M0001D	N	N	N	Y - I	Y - E	Repeatability test passed	
M0001E	N	N	N	Y - I	Y - E	Service Icon manually reset	
M0001F	N	N	N	Y - S	Y - E	Configuration backup complete	
M00020	N	N	N	Y - S	Y - E	Calibration backup complete	
M00021	N	N	N	Y - I	N	*** Log cleared	'***' indicates the name of the Log file that was cleared
M0002D	N	N	N	N	Y - E	Monitor Cell Overload	
M0002E	N	N	N	N	Y - E	Monitor Cell Zero Drift Success	
M0002F	N	N	N	N	Y - E	Monitor Cell Zero Drift Failure	
M00030	N	N	N	N	Y - E	Monitor Symmetry Drift Failure	
M00031	N	N	N	N	Y - E	Monitor Symmetry Comm Success	
M00032	N	N	N	N	Y - E	Monitor Symmetry Comm Failure	
M00033	N	N	N	N	Y - E	Monitor Symmetry Check Success	
M0003B	N	N	N	N	Y - E	Service Icon status change - ON to OFF	
M0003C	N	N	N	N	Y - E	Service Icon status change - OFF to ON	
M0003D	N	N	N	N	Y - E	Configuration Restored from USB	
M0003E	N	N	N	N	Y - E	Calibration restored from USB	
M0003F	N	N	N	N	Y - E	Calibration expired - No action	Occurs when Calibration Management is set to "No Action"
N00001	Y	Y	N	N	N	Invalid MAC Address	Cannot be resolved. Main board requires replacement.
N00002	N	N	N	Y - I	N	***' exported via USB	'***' indicates the name of exported file

IND570 Error/Event Code	Error Log Record (Y/N)	Service Icon (Y/N)	System Alarm Discrete Output (Y/N)	Email (Y/N - Category)	InTouch (Y/N -Category)	Displayed or Recorded Error/Event Message	Comment(s)
000033	N	Y	N	Y - W	Y - A	Calibration expired. Scale disabled. Run Calibration test.	Occurs when Calibration Expiration is set to "Alarm & Disable"
000049	Y	Y	N	N	N	Factory pre-calibration checksum error. Main board cannot be used. Replace main board.	Occurs when Calibration Expiration is set to "Alarm & Disable"
00004E	N	Y	N	Y - W	N	Sensitivity expired. Scale disabled. Retest required.	Occurs when Calibration Expiration is set to "Alarm & Disable"
00004F	N	Y	N	Y - W	N	Eccentricity expired. Scale disabled. Retest required.	Occurs when Calibration Expiration is set to "Alarm & Disable"
000050	N	Y	N	Y - W	N	Repeatability expired. Scale disabled. Retest required.	Occurs when Calibration Expiration is set to "Alarm & Disable"
000052	Y	N	N	N	N	Backup failure	Calibration, Configuration, TaskExpert, Template backup to USB failed to complete
000056	N	N	N	Y - W	N	Calibration - Warning Limit failure	Calibration test passed but a Warning Limit failure was recorded.
000057	N	N	N	Y - W	N	Sensitivity - Warning Limit failure	Sensitivity test passed but a Warning Limit failure was recorded.
000058	N	N	N	Y - W	N	Eccentricity - Warning Limit failure	Eccentricity test passed but a Warning Limit failure was recorded.
000059	N	N	N	Y - W	N	Repeatability - Warning Limit failure	Repeatability test passed but a Warning Limit failure was recorded.
00005A	N	Y	N	Y - F	Y - A	Calibration - Control Limit failure	Calibration test failed because a Control Limit failure was recorded.
00005B	N	Y	N	Y - F	Y - A	Sensitivity - Control Limit failure	Sensitivity test failed because a Control Limit failure was recorded.
00005C	N	Y	N	Y - F	Y - A	Eccentricity - Control Limit failure	Eccentricity test failed because a Control Limit failure was recorded.
00005D	N	Y	N	Y - F	Y - A	Repeatability - Control Limit failure	Repeatability test failed because a Control Limit failure was recorded.
000063	N	Y	N	N	Y - A	Calibration Failure	
00006F	Y	N	N	N	N	USB export error	Terminal failed to successfully transfer a file to a USB memory device.
000070	N	N	N	Y - W	Y - E	SW1-1 OFF after being ON	
000080	N	Y	N	Y - I	Y - A	Calibration expired. Run Calibration Test.	Occurs when Calibration Expiration is set to "Alarm Only"

IND570 Error/Event Code	Error Log Record (Y/N)	Service Icon (Y/N)	System Alarm Discrete Output (Y/N)	Email (Y/N - Category)	InTouch (Y/N -Category)	Displayed or Recorded Error/Event Message	Comment(s)
000081	N	Y	N	Y - I	N	Sensitivity expired. Please run Sensitivity Test.	Occurs when Calibration Expiration is set to "Alarm Only"
000082	N	Y	N	Y - I	N	Eccentricity expired. Please run Eccentricity Test.	Occurs when Calibration Expiration is set to "Alarm Only"
000083	N	Y	N	Y - I	N	Repeatability expired. Please run Repeatability Test.	Occurs when Calibration Expiration is set to "Alarm Only"
P00002	Y	N	N	Y - W	N	PLC is offline	PLC is 'Offline' after being confirmed 'Online'
S00002	N	N	N	Y - W	N	Change Log at 75%	When Change Log reaches 100%, no more writes to shared data will occur. This can affect terminal function
S00003	N	N	N	Y - W	Y - E	Change Log at 90%	When Change Log reaches 100%, no more writes to shared data will occur. This can affect terminal function.
S00004	N	Y	N	Y - F	Y - A	Change Log at 100%	When Change Log reaches 100%, no more writes to shared data will occur. This can affect terminal function.
T00001	Y	N	Y	N	N	Remote scale – No data transfer	Error occurs when scale type is "Remote" and incoming data transfer is not detected.



# 6 Parts and Accessories

	 <b>WARNING</b>
	<p><b>IF THE KEYBOARD, DISPLAY LENS OR ENCLOSURE IS DAMAGED ON A DIVISION 2 OR ZONE 2/22 APPROVED IND570xx TERMINAL THAT IS USED IN A DIVISION 2 OR ZONE 2/22 AREA, THE DEFECTIVE COMPONENT MUST BE REPLACED IMMEDIATELY. REMOVE POWER IMMEDIATELY AND DO NOT REAPPLY POWER UNTIL THE DISPLAY LENS, KEYBOARD OR ENCLOSURE HAS BEEN REPLACED BY QUALIFIED SERVICE PERSONNEL. FAILURE TO DO SO COULD RESULT IN BODILY HARM AND/OR PROPERTY DAMAGE.</b></p>

## 6.1. Harsh Enclosure

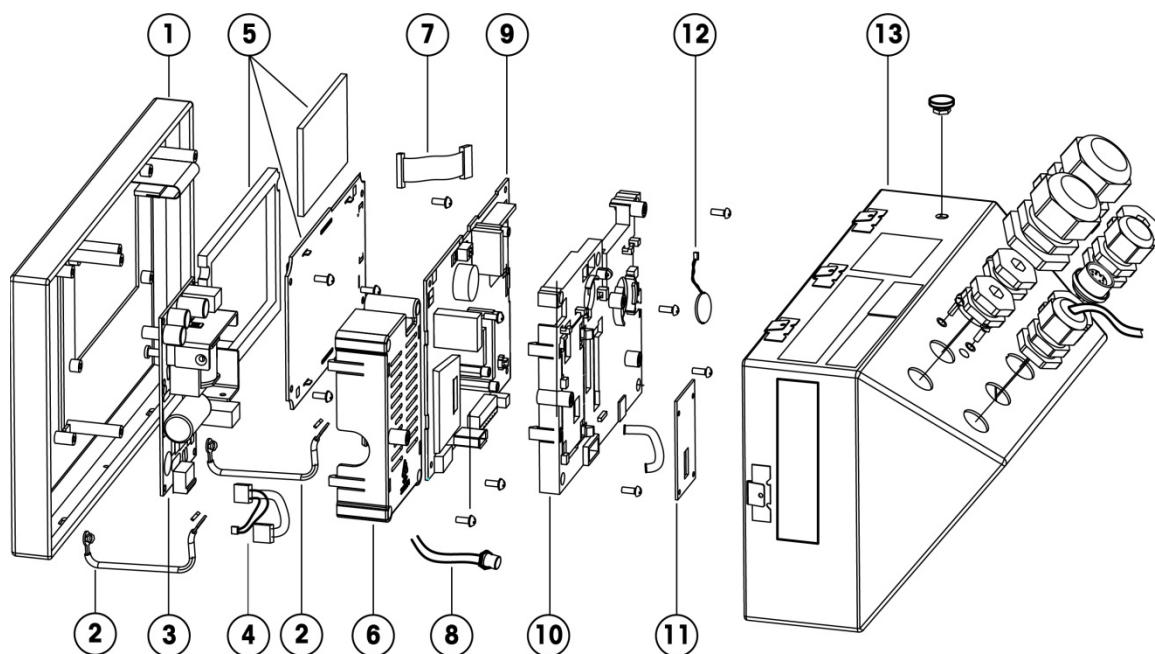

### 6.1.1. Harsh Enclosure Parts

Item No.	Part Description	Part No.
1	Front cover with attached keyboard – IND570 (analog, IDNet, SICSPRO)	30130815
	Front cover with attached keyboard - IND570xx (analog, IDNet, SICSPRO, POWERCELL)	30130838
	Front cover with attached keyboard – IND570 (POWERCELL)	30344967
Not shown	Keyboard assembly (membrane and harness) – IND570 (all)	30237702
	Keyboard assembly (membrane and harness) - IND570xx (all)	30237703

Item No.	Part Description	Part No.	
2	Front cover ground straps (harsh enclosure)	72184340	
3	AC power supply PCB with harness	30130817	
	AC power supply PCB with harness (POWERCELL only)	30344968	
	DC power supply PCB with harness	30130818	
4	Power supply harness only (analog, IDNet, SICSpro)	30247471	
	Power supply harness only (POWERCELL)	30344969	
5	OLED display assembly, thick lens for IND570xx, display gasket	30552913	
	LCD display assembly, thick lens for IND570xx, display gasket	30537950	
6	Power supply plastic cover (either AC or DC)	30130819	
	Power supply plastic cover (POWERCELL only)	30344970	
7	Display harness (OLED and LCD)	30237704	
8	IDNet harness and connector	30139557	
	SICSpro harness and connector	30282884	
	M12 PowerDeck harness and connector (not certified for use with IND570xx POWERCELL)	30411436	
9	Main PCB, analog – IND570	30130823	
	Main PCB, analog – IND570xx	30130825	
	Main PCB, IDNet and SICSpro – IND570	30130824	
	Main PCB, SICSpro – IND570xx	30130826	
	Main PCB, IDNet – IND570xx	30411460	
	Main PCB, POWERCELL – IND570	30344965	
	Main PCB, POWERCELL – IND570xx	30344971	
10	Plastic main PCB cover, analog	30237705	
	Plastic main PCB cover, IDNet and SICSpro	30237706	
	Plastic main PCB cover, POWERCELL	30344966	
11	IDNet scale interface PCB	30130816	
	SICSpro scale interface PCB	30282883	
12	Battery assembly, with connecting harness	30237707	
13	IND570 rear housing assembly, US line cord (analog, IDNet, SICSpro) -not available for IND570xx	Includes blank plugs in all openings, appropriate labels, and power cord <b>Note:</b> Requires special handling – data label must be re-created with original serial number.	30237690
	IND570 rear housing assembly, Schuko (EU) line cord (analog, IDNet, SICSpro) - not available for IND570xx		30237691

Item No.	Part Description	Part No.
	IND570 rear housing assembly, US line cord (POWERCELL) - not available for IND570xx	30345016
Not shown	2 fixed angle mounting brackets (harsh enclosure)	71209353
	Gland and plug kit (harsh enclosure), includes 2 16mm glands, 2 16mm blanks, 1 25mm gland, 1 25mm blank	30130830
	Gland and plug kit (ATEX, IECEx) - IND570xx	30130837
	POWERCELL gland kit	72243220
	Conduit hub kit (cFMus) - IND570xx	30130839
	Schuko (EU) line cord	71207880
	Switzerland line cord	71207881
	UK line cord	71207882
	Australia line cord	71207883
	India / South Africa line cord	72205937
	U.S. line cord	71207879
	Denmark line cord	30254839
	Line cord with ferrules, no plug (ATEX, IECEx) – IND570xx	72227501

## 6.2. Panel-Mount Enclosure

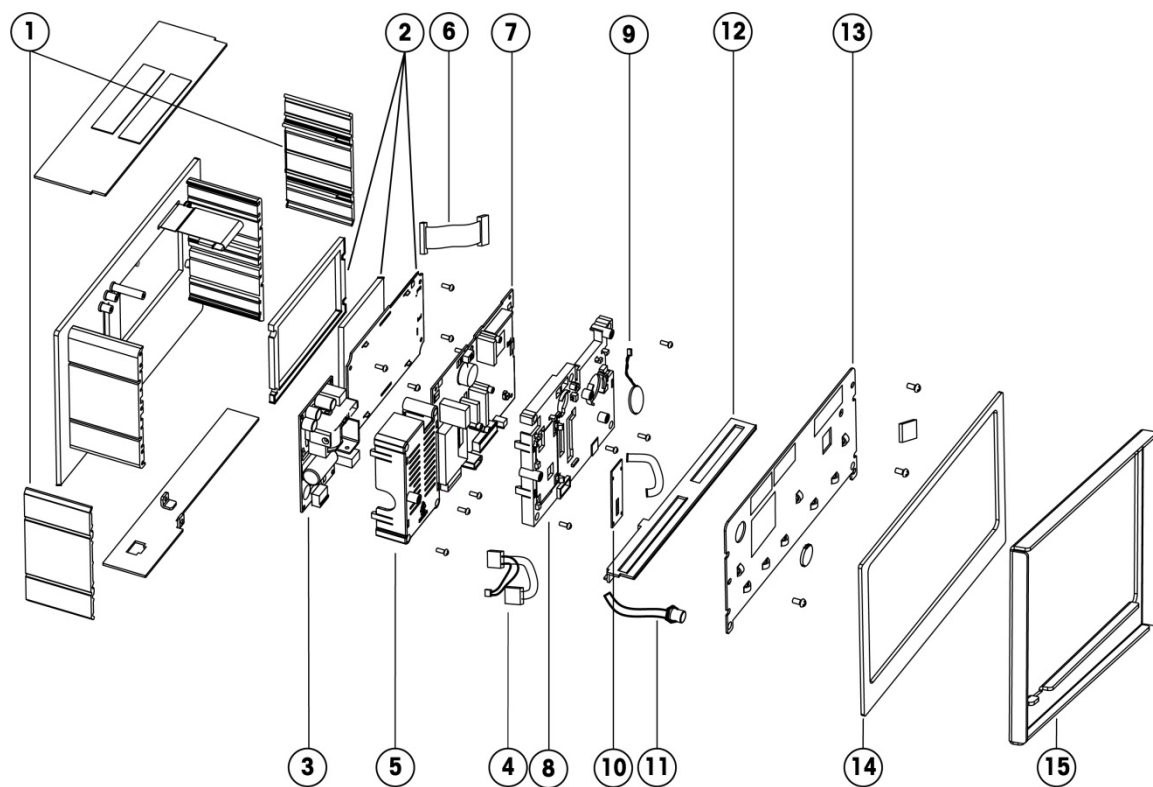

### 6.2.1. Panel Enclosure Parts

Item No.	Part Description	Part No.
1	2 side mounting clamps and 4 set screws	30130835
Not shown	Keyboard assembly (membrane and harness) – IND570	30237702
	Keyboard assembly (membrane and harness) – IND570xx	30237703
2	OLED display assembly, thick lens for IND570xx, display gasket	30552913
	LCD display assembly, thick lens for IND570xx, display gasket	30537950
3	AC power supply PCB with harness	30130817
	AC power supply PCB with harness (POWERCELL only)	30344968
	DC power supply PCB with harness	30130818
4	Power supply harness only (analog, IDNet, SICSpro)	30247471
	Power supply harness only (POWERCELL)	30344969
5	Power supply plastic cover (either AC or DC)	30130819
	Power supply plastic cover (POWERCELL only)	30344970
6	Display harness (OLED and LCD)	30237704

Item No.	Part Description	Part No.
7	Main PCB, analog	30130823
	Main PCB, analog – IND570xx	30130825
	Main PCB, IDNet and SICSpro	30130824
	Main PCB, SICSpro – IND570xx	30130826
	Main PCB, IDNet – IND570xx	30411460
	Main PCB, POWERCELL – IND570	30344965
	Main PCB, POWERCELL – IND570xx	30344971
8	Plastic main PCB cover, analog	30237705
	Plastic main PCB cover, IDNet and SICSpro	30237706
	Plastic main PCB cover, POWERCELL	30344966
9	Battery assembly, with connecting harness	30237707
10	IDNet scale interface PCB	30130816
	SICSpro scale interface PCB	30282883
11	IDNet harness and connector	30139583
	SICSpro harness and connector	30282885
	M12 PowerDeck harness and connector (not certified for use with IND570xx POWERCELL)	30411436
12	Options plastic cover with inserts	30130821
13	Metal rear cover assembly, includes 3 screws, Ethernet and IDNet covers	30130822
14	Sealing gasket (panel mount enclosure)	71209390
15	Panel stiffener bracket (IND570xx)	30282898

## 6.3. Miscellaneous Parts

Part Description	Part No.
Hardware kit, includes 4 copper standoffs, 6 M4 screws (two lengths), 4 M3 screws, Ethernet and IDNet protective covers for panel-mount, 4 plastic plugs	30130831
Connector kit, includes 1 6-pin, 1 8-pin, 1 2-pin and 1 3-pin green connector	30130832
Connector kit (POWERCELL only), includes 1 2-pin, 1 3-pin, 1 5-pin and 1 7-pin green connector	30345015
Option connectors kit, includes 4 8-pin (two sizes), 1 7-pin, 1 3-pin, 2 4-pin (two sizes), 2 10 pin (two sizes), 1 5-pin	30139585
Capacity label kit (includes 5 labels)	64057354

## 6.4. Options and Accessories

### 6.4.1. Positionable Mounting Bracket



Part Description	Part No.
Single hole mounted swivel/ tilt bracket (fits IND570 terminals manufactured before May 2016)	22015188
Single hole mounted swivel/tilt bracket (fits IND570 terminals manufactured May 2016 and later with VESA hole spacing)	22020286

### 6.4.2. Mounting Bracket Adapter Plate



Part Description	Part No.
Adapter plate and hardware to adapt older bracket hole spacing from 22015188 bracket to new VESA hole spacing in IND570 terminals manufactured May 2016 and later.	30353299

### 6.4.3. External USB Adapter (harsh)



Part Description	Part No.
External USB port for harsh terminal. Includes internal extension harness and IP68 cover. <span style="color: blue;">■</span> Not certified for use in IND570xx	30139559

**6.4.4. External Ethernet Adapter**



Part Description	Part No.
External Ethernet port for harsh terminal. Includes internal extension harness only. ■ Part number 301395652 can be used with cable part number 22017610 (Cable, M12 to Ethernet-RJ45) ■ Not certified for use in IND570xx	30139561

**6.4.5. External Metrology Sealing Kit**



Part Description	Part No.
Weights and Measures Sealing Kit (harsh and panel) Includes 3 special screws, wire and plastic clasp/seal for W&M application. Additional plastic cover, metal bracket and 4th unique screw are provided for W&M applications in China.	30130836
Spare wire seal	72996394
METTLER TOLEDO self-destructing security sealing label for W&M applications	68001451

### 6.4.6. MID Labelset – IND570

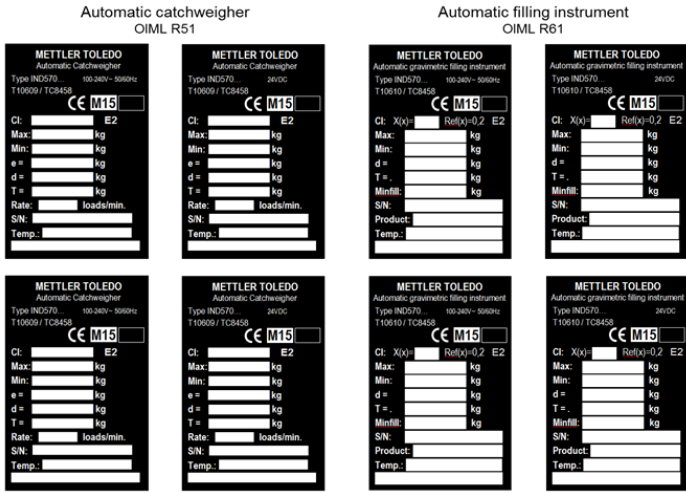

Part Description	Part No.
MID Labelset – IND570	30300815

### 6.4.7. IND Terminals – Harsh Enclosure Clip Release Tool



Part Description	Part No.
Harsh enclosure clip release tool for IND terminals	64092698



**6.4.8. Ethernet TCP/IP Interface**

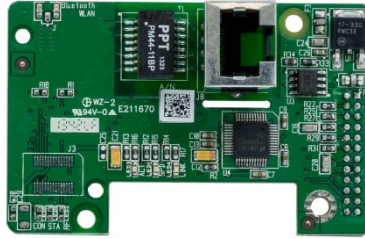

Part Description	Part No.
Ethernet TCP/IP option	30113538

**6.4.9. Analog Output**

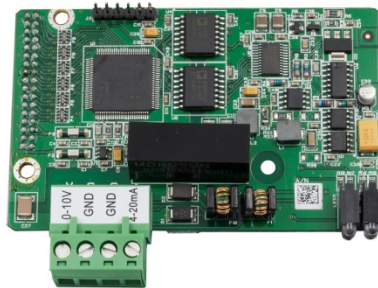

Part Description	Part No.
Analog Output option	30113588

**6.4.10. ControlNet PLC Interface**

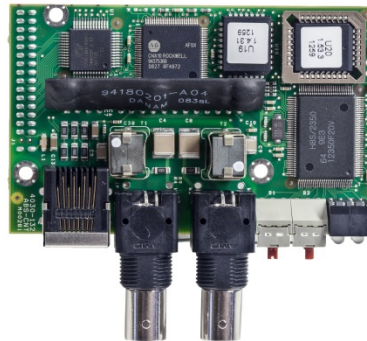

Part Description	Part No.
ControlNet option	30113544

**6.4.11. DeviceNet PLC Interface**

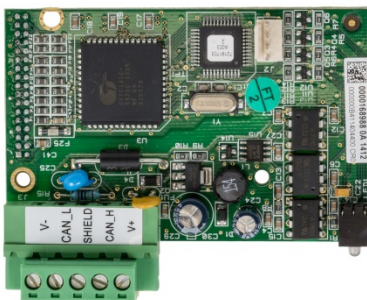

Part Description	Part No.
DeviceNet option	30116110

**6.4.12. EtherNet/IP – Modbus TCP PLC Interface**

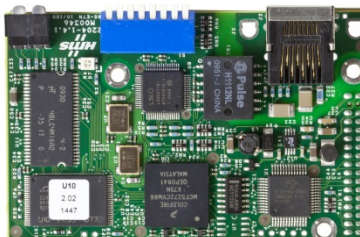

Part Description	Part No.
EtherNet/IP – Modbus TCP option	30116112

**6.4.13. PROFIBUS, Harsh Enclosure**

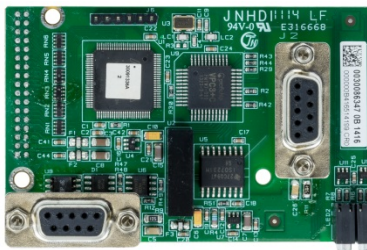

Part Description	Part No.
PROFIBUS, harsh enclosure option	30113590

**6.4.14. PROFIBUS, Panel Enclosure**

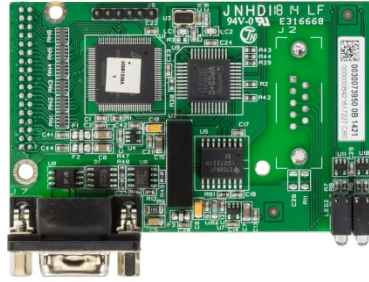

Part Description	Part No.
PROFIBUS, panel-mount enclosure option	30113589

**6.4.15. PROFINET PLC Interface**

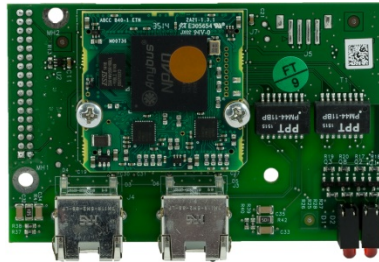

Part Description	Part No.
PROFINET option	30260484

**6.4.16. COM2/COM3 Interface**

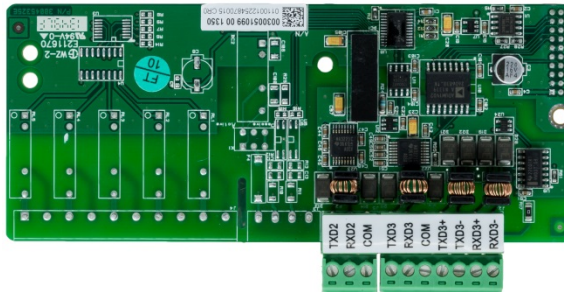

Part Description	Part No.
COM2/COM3 interface option	30113539

**6.4.17. DIO, Relay, 5 Inputs, 8 Outputs**

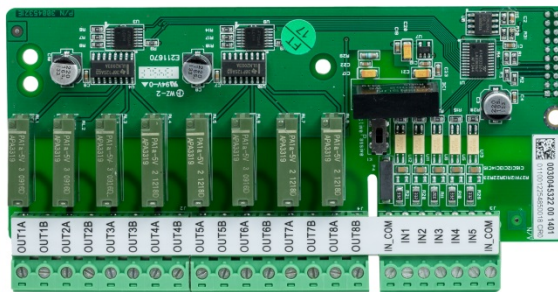

Part Description	Part No.
DIO - 5 inputs, 8 outputs, relay option	301 13540

**6.4.18. DIO, Solid State, 5 Inputs, 8 Outputs**

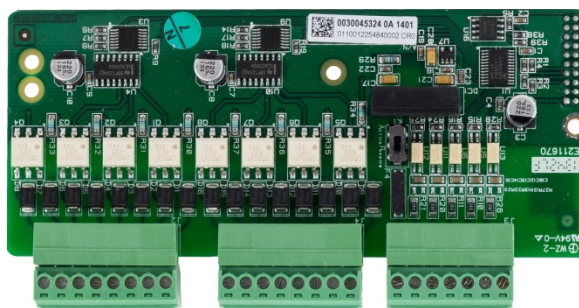

Part Description	Part No.
DIO - 5 inputs, 8 outputs, solid state option	301 13541

**6.4.19. COM2/COM3/DIO, Relay, 2 Inputs, 5 Outputs**

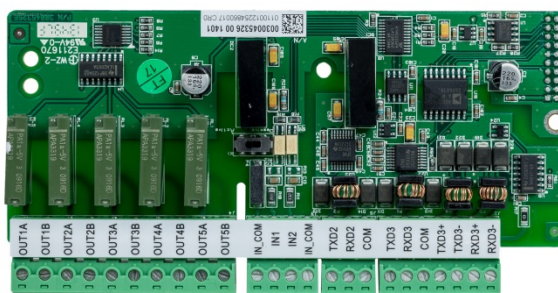

Part Description	Part No.
COM2/COM3/DIO (2 inputs, 5 outputs, relay) option	301 13542

**6.4.20. COM2/COM3/DIO, Solid State, 2 Inputs, 5 Outputs**



Part Description	Part No.
COM2/COM3/DIO (2 inputs, 5 outputs, solid state) option	30113543

**6.4.21. WiFi Option Kit, Terminal-Mounted**



Part Description	Part No.
WiFi Option Kit, Terminal-Mounted	30499148



### 6.4.22. WiFi Option Kit, Remotely-Mounted



Part Description	Part No.
WiFi Option Kit, Remotely-Mounted	30499149

## 6.5. Software Applications

- Application kits include application hardware key (ibutton), documentation and software files for download into the terminal (if required)



### 6.5.1. TaskExpert

Part Description	Part No.
TaskExpert	30139632

### 6.5.2. COM-570

Part Description	Part No.
COM-570	30139633

**6.5.3. COM-570/TaskExpert**

Part Description	Part No.
COM-570 and TaskExpert	30139634

**6.5.4. Fill-570**

Part Description	Part No.
Fill-570	30139635

**6.5.5. Fill-570/TaskExpert**

Part Description	Part No.
Fill-570 and TaskExpert (Requires V2.00.0033 or newer firmware to operate correctly)	30139636

**6.5.6. Fill-570/COM-570**

Part Description	Part No.
Fill-570 and COM-570	30139637

**6.5.7. Drive-570**

Part Description	Part No.
Drive-570	30139638

**6.5.8. Drive-570/TaskExpert**

Part Description	Part No.
Drive-570 and TaskExpert	30139639

**6.5.9. Drive-570/COM-570**

Part Description	Part No.
Drive-570 and COM-570	30139640

# A Default Settings

## A.1. Setup Defaults and Security Access

The following tables list the factory default settings of the IND570 along with the security level required to access each IND570 setup parameters or setup function (if user security is Enabled).

- Not all settings are available for all scale types. The Scale section (Table A-1) includes separate columns for each scale type. If a setting is available for the scale type, the default setting is listed in the corresponding column. Parameters listed with dashes (--) are not available for that scale type.

**Table A-1: Setup Defaults and Security Access – Scale Branch**

Setup Feature	Default Value				Security Access
	Analog Scale	IDNet Scale	SICSpro Scale	POWERCELL Scale	
<b>Scale – Type</b>					
Name	Scale 1	Scale 1	Scale 1	Scale 1	Maintenance
Scale Type (automatically determined)	Analog	IDNet	SICSpro	POWERCELL	Administrator
Platform Serial Number	--	--	Display only	--	--
Application	--	--	--	Vehicle	Administrator
Approval	None	--	Display only	None	Administrator
Number of Load Cells	--	--	--	8	Administrator
Class	III	III	Display only	III	Administrator
Verified Interval – Refer to 3.5.1.1.5.	e=d	e=d	Display only	e=d	Administrator
Power Up Delay – Refer to 3.5.1.1.6.	Disabled	--	--	--	Administrator
<b>Scale – Advanced Setup Mode</b>					
Advanced Setup Mode (ASM) is found only in the SICSpro type scales. Settings such as Capacity, Increment, Zero, Tare, Filtering and Calibration are found within ASM.					Administrator
<b>Scale – Capacity &amp; Increment</b>					
Primary Units	kg	Determined by platform	--	kg	Administrator
# of Ranges	1	--	--	1	Administrator
> I <	50 x 0.01	--	--	50 x 0.01	Administrator



Setup Feature	Default Value				Security Access
	Analog Scale	IDNet Scale	SICSpro Scale	POWERCELL Scale	
Blank Over Capacity	5 d	--	--	5 d	Administrator
x10 Always	--	Disabled	--	--	Administrator
<b>Scale – Calibration</b>					
Service Mode	--	Access to IDNet Service Mode	--	--	Administrator
Geo Code	16	--	--	16	Administrator
Base Serial Number	[blank]	[blank]	--	[blank]	Administrator
Calibration Units	kg	--	--	Kg	Administrator
Linearity Adjust	Disabled	--	--	Disabled	Administrator
Analog Gain Jumper	3 mV/V	--	--	--	Administrator
CalFree Cell Capacity	50	--	--	--	Administrator
CalFree Cell capacity Unit	kg	--	--	--	Administrator
CalFree Rated Cell Output	3 mV/v	--	--	--	Administrator
CalFree Estimated Preload	0	--	--	0.00	Administrator
CalFree Estimated Preload Unit	kg	--	--	kg	Administrator
Capture Zero	--	--	--	--	Administrator
Capture Span	--	--	--	--	Administrator
Step Calibration Test Weight	[blank]	--	--	[blank]	Administrator
<b>Scale – Zero – AZM &amp; Display</b>					
Auto Zero	Gross	--	--	Gross	Administrator
Auto Zero	Enabled	Enabled	--	--	Administrator
Auto Zero Range	0.5 d	**	--	3 d	Administrator
Under Zero Blanking	5 d	**	--	5 d	Administrator
Power up	Restart	Restart	--	Restart	Administrator
Timed Zero	Disabled	Disabled	Disabled	Disabled	Administrator
<b>Scale – Zero – Ranges</b>					
Power Up Zero	Disabled	--	--	Disabled	Administrator
Power Up Range	+ 0 % – 0 %	--	--	+ 0 % – 0 %	Administrator
Pushbutton Zero	Enabled	Enabled	--	Enabled	Administrator
Pushbutton Range	+ 2 % – 2 %	--	--	+ 2 % – 2 %	Administrator
<b>Scale – Tare – Types</b>					
Pushbutton Tare	Enabled	Enabled	--	Enabled	Administrator
Keyboard Tare	Enabled	Enabled	--	Enabled	Administrator

Setup Feature	Default Value				Security Access
	Analog Scale	IDNet Scale	SICSpro Scale	POWERCELL Scale	
Net Sign Correction	Disabled	Disabled	--	Disabled	Administrator
Terminal Tare	--	Disabled	--	--	Administrator
<b>Scale – Tare – Auto Tare</b>					
Auto Tare	Disabled	Disabled	--	Disabled	Administrator
Tare Threshold Weight	0 kg	0 kg	--	0 kg	Administrator
Reset Threshold Weight	0 kg	0 kg	--	0 kg	Administrator
Motion Check	Enabled	Enabled	--	Enabled	Administrator
<b>Scale – Tare – Auto Clear</b>					
Auto Clear Tare	Disabled	Disabled	--	Disabled	Administrator
Clear Threshold Weight	0 kg	0 kg	--	0 kg	Administrator
Motion Check	Enabled	Enabled	--	Enabled	Administrator
Clear After Print	Disabled	Disabled	--	Disabled	Administrator
Clear With Zero	Disabled	Disabled	--	Disabled	Administrator
Power Up	Restart	Restart	--	Restart	Administrator
<b>Scale – Units</b>					
Second Unit	None				Administrator
Third Unit	None				Administrator
Power Up	Restart				Administrator
Custom Factor	1				Administrator
Custom Name	Cust				Administrator
Custom Increment	0.1				Administrator
<b>Scale – Rate</b>					
Weight Units	None				Maintenance
Time Units	Seconds				Maintenance
Measurement Period	1				Supervisor
Output Average	1		5		Supervisor
<b>Scale – Filter</b>					
Low Pass Frequency	2.0 Hz	--	--	2.0 Hz	Maintenance
Low Pass # of Poles	8	--	--	8	Maintenance
Notch Filter Frequency	30 Hz	--	--	30 Hz	Maintenance
Stability Filter	Disabled	--	--	Disabled	Maintenance
Vibration	--	Average Conditions	--	--	Maintenance
Weighing Process	--	Universal Weighing	--	--	Maintenance

Setup Feature	Default Value				Security Access
	Analog Scale	IDNet Scale	SICSpro Scale	POWERCELL Scale	
<b>Scale – Stability</b>					
Motion Range	1 d	--	--	1 d	Administrator
No-motion Interval	0.3 seconds	--	--	0.3 seconds	Administrator
Stability	--	2	--	--	Administrator
Timeout	3 seconds	3 seconds	3 seconds	3 seconds	Maintenance
<b>Scale – Log or Print</b>					
Minimum Wt.	0 kg				Maintenance
Interlock	Disabled				Maintenance
Automatic	Disabled				Maintenance
Reset on	Return, 0 kg				Maintenance
Threshold Wt.	0 kg				Maintenance
Motion Check	Disabled				Maintenance
<b>Scale – MinWeigh</b>					
MinWeigh	Disabled				Supervisor
Uncertainty U <sub>0</sub>	0 kg				Supervisor
Uncertainty c	0				Supervisor
Tolerance	0.1				Supervisor
Safety Factor	1				Supervisor
MinWeigh Value	0 kg				Supervisor
<b>Scale – Reset</b>					
Reset branch to factory defaults	--				Administrator

**Table A-2: Setup Defaults and Security Access – Application, Terminal, Communication and Maintenance Branches**

Setup Feature	Default Value	Security Access
<b>Application – Memory – Alibi</b>		
Alibi Memory	Disabled	Administrator
Print from Setup	--	Supervisor
<b>Application – Memory – Tare Table</b>		
Description	Disabled	Maintenance
Totalization	Disabled	Maintenance
Clear Table	--	Maintenance
Records 01–99	[blank]	Supervisor

Setup Feature	Default Value	Security Access
<b>Application – Memory – Message Table</b>		
Clear Table	--	Supervisor
Records 01–99	[blank]	Supervisor
<b>Application – Memory – Target Table</b>		
Mode	None	Maintenance
Tolerance Type	Target Deviation	Maintenance
Output Type	Concurrent	Maintenance
<b>Application – Memory – Totalization Table</b>		
<b>Setup Feature</b>		
<b>Default Value</b>		
<b>Security Access</b>		
Totalization	Disabled	Maintenance
Records 01–200	[blank]	Supervisor
<b>Application – Operation – Target Table</b>		
Source	Displayed Weight	Maintenance
Latching	Enabled	Maintenance
Motion Check	Disabled	Maintenance
<b>Application – Operation – Comparators Table</b>		
Source	None	Supervisor
Active	<	Supervisor
Description	[blank]	Supervisor
Limit	0	Supervisor
High Limit	0	Supervisor
Clear Comparators	--	Maintenance
<b>Application – Operation – Totalization Table</b>		
Mode	None	Maintenance
Clear GT on Print	Disabled	Maintenance
Subtotal	Disabled	Maintenance
Clear ST on Print	Disabled	Maintenance
Convert Weight	Enabled	Maintenance
<b>Application – Operation – ID1...ID4 Table</b>		
Mode	Disabled	Maintenance
Threshold (ID1 only)	0	Maintenance
Reset (ID1 only)	0	Maintenance
Looping	Disabled	Maintenance
<b>Application – Discrete I/O – Inputs Table</b>		
Discrete Inputs	[blank]	Maintenance

Setup Feature	Default Value	Security Access
<b>Application – Discrete I/O – Outputs</b>		
Discrete Outputs	[blank]	Maintenance
<b>Application – Task Expert - Start (Shown only if module is installed)</b>		
Task File Name	[blank]	N/A
<b>Application – Reset</b>		
Reset branch to factory defaults	--	Administrator
<b>Terminal – Device</b>		
Terminal ID#1	IND570	Maintenance
<b>Terminal – Device</b>		
<b>Terminal – Device</b>		
Terminal ID#2	METTLER TOLEDO	Maintenance
Terminal ID#3	[blank]	Maintenance
Serial Number	Populated at factory	Maintenance
Configured Devices Table	[blank]	N/A
<b>Terminal – Display</b>		
Screensaver	Weight, 30 Minutes	Maintenance
Tare Display	Active	Administrator
Auxiliary Display	Disabled	Maintenance
Metrology Line	Cap/d	Administrator
<b>Terminal – Region – Format Time &amp; Date</b>		
Time Format	24:MM:SS	Supervisor
Date Format	DD MMM YYYY	Supervisor
Date Field Separator	/ (slash)	Supervisor
<b>Terminal – Region – Set Time &amp; Date</b>		
Hour	No default values	Supervisor
Minute		
Day		
Month		
Year		
<b>Terminal – Region – Language</b>		
Display Messages	English	Maintenance
Keypad Selection	English	Maintenance
Comma/Decimal	Decimal point	Maintenance
Gross Legend	G	Maintenance
<b>Terminal – Transaction Counter</b>		
Transaction Counter	Enabled	Maintenance

Setup Feature	Default Value	Security Access
Counter Reset	Disabled	Maintenance
Next Transaction	0000001	Maintenance
<b>Terminal – Users</b>		
Username #1	admin	Maintenance
Access #1	Administrator	Maintenance
Password #1	[blank]	Maintenance
Username #2	anonymous	Maintenance
Access #2	Operator	Maintenance
Password #2	[blank]	Maintenance
<b>Terminal – Softkeys</b>		
Softkey 3	Set Time and Date	Maintenance
Softkey 9	Recall Information	Maintenance
Softkey 10	Setup	Maintenance
All Others	[blank]	Maintenance
<b>Terminal – Reset</b>		
Reset branch to factory defaults	--	Maintenance
<b>Communication – Access/Security – Ethernet</b>		
Shared Data Server	Read/Write	Administrator
Web Server	Disabled	Administrator
FTP	Read/Write	Administrator
<b>Communication – Access/Security – USB</b>		
Keyboard and Scanner	Disabled	Maintenance
Memory Stick	Write Only	Maintenance
<b>Communication – Templates – Input</b>		
Preamble Length	0	Maintenance
Data Length	1	Maintenance
Postamble Length	0	Maintenance
Termination Character	CR	Maintenance
Assignment	Tare	Maintenance
<b>Communication – Templates – Output</b>		
Template 1	See Default Templates for format	Maintenance
Template 2	See Default Templates for format	Maintenance
Template 3	[blank]	Maintenance
Template 4	[blank]	Maintenance
Template 5	Refer to Default Templates for format	Maintenance

Setup Feature	Default Value	Security Access
Repeat Print Field	Disabled	Maintenance
<b>Communication – Templates – Strings</b>		
Strings 01–20	[blank]	Maintenance
<b>Communication – Reports Format</b>		
Format	Narrow (40)	Maintenance
Header	2	Maintenance
Title	Enabled	Maintenance
Record Separator	None	Maintenance
Footer	5	Maintenance
<b>Communication – Reports – Tare Table</b>		
Tare	Enabled	Maintenance
Description	Disabled	Maintenance
N	Disabled	Maintenance
Total	Disabled	Maintenance
<b>Communication – Reports – Target Table</b>		
Description	Disabled	Maintenance
Target	Enabled	Maintenance
+/- Tolerances	Disabled	Maintenance
Spill	Disabled	Maintenance
Fine Feed	Disabled	Maintenance
<b>Communication – Connections (one default connection preconfigured)</b>		
Port	COM1	Maintenance
Assignment	Demand	Maintenance
Trigger	Scale	Maintenance
Template	Template 1	Maintenance
<b>Communication – Serial – COM1</b>		
Baud	9600	Maintenance
Data Bits	8	Maintenance
Parity	None	Maintenance
Flow Control	None	Maintenance
Interface	RS-232	Maintenance
<b>Communication – Serial – COM2 (Shown only if option with COM2 is installed)</b>		
Baud	9600	Maintenance
Data Bits	8	Maintenance
Parity	None	Maintenance

Setup Feature	Default Value	Security Access
Flow Control	None	Maintenance
Interface	RS-232	Maintenance
<b>Communication – Serial – COM3 (Shown only if option with COM3 is installed)</b>		
Baud	9600	Maintenance
Data Bits	8	Maintenance
Parity	None	Maintenance
Flow Control	None	Maintenance
Interface	RS-232	Maintenance
<b>Communication – Serial – COM4 (POWERCELL version only)</b>		
Baud	9600	Maintenance
Data Bits	8	Maintenance
Parity	None	Maintenance
Flow Control	None	Maintenance
Interface	RS-232	Maintenance
<b>Communication – Network – Ethernet (Shown only if Ethernet option detected)</b>		
MAC Address	Unique value	Maintenance
<b>Setup Feature</b>		
<b>Default Value</b>		
<b>Security Access</b>		
DHCP Client	Disabled	Maintenance
IP Address	192.168.0.1	Maintenance
Subnet Mask	255.255.255.0	Maintenance
Gateway Address	0.0.0.0	Maintenance
<b>Communication – Network – DNS Server (Shown only if Ethernet option detected)</b>		
Automatic DNS	Enabled	Maintenance
Preferred DNS Server	Blank or auto populated based on Auto DNS setting	Maintenance
Alternate DNS Server	[blank]	Maintenance
<b>Communication – Network – Proxy Server (Shown only if Ethernet option detected)</b>		
Proxy Server	Disabled	Maintenance
Server Address	[blank]	Maintenance
Port	8080	Maintenance
Username	[blank]	Maintenance
Password	[blank]	Maintenance
Confirm Password	[blank]	Maintenance
<b>Communication – Network - Port (Shown only if Ethernet option detected)</b>		
Primary Port #	1701	View Only



Setup Feature	Default Value	Security Access
Secondary Port #	1701	Maintenance
<b>Communication – Network – WiFi Module (Shown only if WiFi option detected.)</b>		
SSID	[blank]	Maintenance
Password	[blank]	Maintenance
DHCP Client	Disabled	Maintenance
IP Address	[192.168.0.1]	Maintenance
Subnet Mask	[255.255.255.0]	Maintenance
Gateway Address	[0.0.0.0]	Maintenance
<b>Communication – Network – WiFi Port (Shown only if WiFi option detected.)</b>		
WiFi Port #	[1701]	Maintenance
<b>Communication – Network – FTP (Shown only if Ethernet option detected.)</b>		
Username #1	admin	Maintenance
Access #1	Administrator	Maintenance
Password #1	admin	Maintenance
Username #2	anonymous	Maintenance
Access #2	Operator	Maintenance
Password #2	[blank]	Maintenance
<b>Communication – Network – Print Client (Shown only if Ethernet option detected)</b>		
Server IP Address	[blank]	Maintenance
Server TCP Port	9001	Maintenance
<b>Communication – Network – Email Alert – Parameters</b>		
SMTP Server IP	0.0.0.0	Maintenance
Sender Email Address	[blank]	Maintenance
Sender Name	[blank]	Maintenance
Username	IND570	Maintenance
Password	[blank]	Maintenance
Setup Feature	Default Value	Security Access
Confirm Password	[blank]	Maintenance
<b>Communication – Network – Email Alert – Recipients</b>		
Email Address	[blank]	Maintenance
Information Alerts	Disabled	Maintenance
Warning Alerts	Disabled	Maintenance
Failure Alerts	Disabled	Maintenance
Service Alert	Disabled	Maintenance
Send Test Email	--	Maintenance

Setup Feature	Default Value	Security Access
<b>Communication – PLC – Analog Output (Shown only if Analog Output option detected)</b>		
Source	Displayed Weight	Maintenance
Output Mode	4-20 mA	Maintenance
Zero Value	0	Maintenance
Full Scale Value		Maintenance
<b>Communication – PLC – ControlNet (Shown only if ControlNet option detected)</b>		
Node Address	99	Maintenance
<b>Communication – PLC – DeviceNet (Shown only if DeviceNet option detected)</b>		
Node Address	63	Maintenance
Data Rate	125 kB	Maintenance
<b>Communication – PLC – PROFIBUS (Shown only if PROFIBUS option detected)</b>		
Node Address	1	Maintenance
Shared Data	Disabled	Maintenance
<b>Communication – PLC – EtherNet/IP, Modbus TCP (Shown only if EtherNet / IP or Modbus TCP option detected)</b>		
Mac Address	Assigned automatically	Maintenance
DHCP Client	Disabled	Maintenance
IP Address	192.168.0.1	Maintenance
Subnet Mask	255.255.255.0	Maintenance
Gateway Address	0.0.0.0	Maintenance
<b>Communication – PLC – Data Format (Shown only if a PLC option detected)</b>		
Operating Mode	Compatibility Mode	Maintenance
Format	Integer	Maintenance
Byte Order	Word Swap	Maintenance
Message Slots	1	Maintenance
<b>Communication – Reset</b>		
Reset branch to factory defaults	--	Maintenance
<b>Maintenance – Configure / View – Change Log</b>		
Change Log	Disabled	Administrator
<b>Maintenance – Configure / View – Maintenance Log</b>		
Maintenance Log	Disabled	Maintenance
Manual Maintenance Log Entry	--	Maintenance
<b>Maintenance – Configure / View – PWRCL Performance Log</b>		
Log Interval	168.0 Hours	Maintenance
<b>Maintenance – Configure / View – Error Log</b>		
Error Log	Disabled	Administrator

Setup Feature	Default Value	Security Access
Clear Error Log	--	Supervisor
<b>Maintenance – Configure / View – GWP Log</b>		
GWP	Disabled	Administrator
Clear GWP Log	--	Supervisor
<b>Maintenance – Configure / View – Calibration Management</b>		
Test Interval (Days)	0	Maintenance
Test Interval (Weighments)	0	Maintenance
On Expiration	No Action	Maintenance
Last Date Tested	Current Date	View Only
Next Test Date	Calculated from test interval (Days)	View Only
# of Weighments Left	Calculated from test interval (Weighments)	View Only
<b>Maintenance – Configure / View – Test Manager GWP – Sensitivity, Eccentricity &amp; Repeatability (Identical settings for all 3 GWP tests)</b>		
Test Interval (Days)	0	Maintenance
Test Interval (Weighments)	0	Maintenance
On Expiration	No Action	Maintenance
Last Date Tested	Current Date	View Only
Next Test Date	Calculated from test interval (Days)	View Only
# of Weighments Left	Calculated from test interval (Weighments)	View Only
<b>Maintenance – Configure / View – Calibration Test</b>		
Test Load Units	kg	Maintenance
Operator Test Weight Edit	Disabled	Maintenance
Test Weight Table	[blank]	Supervisor
Calibration Test Sequence	[blank]	Supervisor
Clear Calibration Test	--	Supervisor
<b>Maintenance – Configure / View – GWP Tests - Sensitivity</b>		
Test Load Units	kg	Maintenance
Operator Test Weight Edit	Disabled	Maintenance
<b>Setup Feature</b>	<b>Default Value</b>	<b>Security Access</b>
Test Weight Table	[blank]	Supervisor
Sensitivity Test Sequence	Default Test Prompts	Supervisor
Clear Sensitivity Test	--	Supervisor
<b>Maintenance – Configure / View – GWP Tests – Eccentricity</b>		
Test Load Units	kg	Maintenance

Setup Feature	Default Value	Security Access
Test Load	0	Supervisor
Warning Limit	0	Maintenance
Control Limit	0	Maintenance
Operator Test Weight Edit	Disabled	Maintenance
Test Weight Table	[blank]	Supervisor
Eccentricity Test Sequence	Default Test Prompts	Supervisor
Clear Eccentricity Test	--	Supervisor
<b>Maintenance – Configure / View – GWP Tests – Repeatability</b>		
Test Load Units	kg	Maintenance
Test Load	0	Supervisor
Warning Limit	0	Maintenance
Control Limit	0	Maintenance
Number of Weighments	0	Supervisor
Operator Test Weight Edit	Disabled	Maintenance
Test Weight Table	[blank]	Supervisor
Repeatability Test Sequence	Default Test Prompts	Supervisor
<b>Maintenance – Configure / View – InTouch</b>		
InTouch	Disabled	Maintenance
<b>Maintenance – Configure / View – Reset</b>		
Reset Configure/View branch to factory defaults	--	Administrator
<b>Maintenance – Run – Calibration Test</b>		
User ID	[blank]	N/A
Run Test	--	N/A
<b>Maintenance – Run – GWP Test – Sensitivity, Eccentricity, Repeatability</b>		
User ID	[blank]	N/A
Run Test	--	N/A
<b>Maintenance – Run – Diagnostics – Display Test</b>		
Start Test	--	N/A
<b>Maintenance – Run – Diagnostics – Keyboard Test</b>		
Run Test	--	N/A
<b>Maintenance – Run – Diagnostics – Scale – Calibration Values</b>		
Zero (Counts)	0	Administrator
Test Load #1 (Weight)	50	Administrator
Test Load #1 (Counts)	800,000	Administrator

Setup Feature	Default Value	Security Access
<b>Maintenance – Run – Diagnostics – Scale – Statistics</b>		
Weighments	0	View Only
Overloads	0	View Only
Peak Weight	0 kg	View Only
Zero Commands	0	View Only
Zero Fail	0	View Only
<b>Maintenance – Run – Diagnostics – Scale – Installation Guidance</b>		
Leveling Guidance	n/a	View Only
<b>Maintenance – Run – Diagnostics – Serial Test</b>		
Com Port	COM1	Maintenance
Start Test	--	Maintenance
<b>Maintenance – Run – Diagnostics – Discrete I/O Test – Local, Remote</b>		
OK (Run Test)	--	Maintenance
<b>Maintenance – Run – Diagnostics – Network Test</b>		
Start Test	--	Maintenance
<b>Maintenance – Run – Diagnostics – WiFi Scan</b>		
Start	--	Maintenance
<b>Maintenance – Run – Diagnostics – Reset Flash2</b>		
Start	--	Maintenance
<b>Maintenance – Run – Diagnostics – Reset Service Icon</b>		
Start	--	Maintenance
<b>Maintenance – Run – Replace Battery</b>		
Start	--	Maintenance
<b>Maintenance – Run – Install Upgrade</b>		
Start	--	Maintenance
<b>Maintenance – Run – Backup to USB</b>		
Backup	Calibration	Supervisor
Start	--	Supervisor
<b>Maintenance – Run – Restore from USB</b>		
Restore	Calibration	Supervisor
Start (Calibration)	--	Administrator
Start (Configuration)	--	Maintenance
Start (TaskExpert)	--	Supervisor
Start (Templates)	--	Maintenance













Setup Feature	Default Value	Security Access
<b>Maintenance – Reset All</b>		
Reset ALL setup parameters to factory defaults	--	Maintenance

















## A.2. Softkeys Security Access













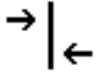

The following table lists the default security levels required to access and initiate IND570 functions and applications available through softkeys.

- The access information assumes that User Security has been enabled in the IND570.

**Table A-3: Softkey Security Access**

Icon	Function	Security Access
<b>Information Recall Functions</b>		
	Recall information	N/A
	Metrology Recall	N/A
	TaskExpert™ Checksum	N/A
	System Information Recall	N/A
	WiFi Information Recall	N/A
	Connected Devices Recall	N/A
	Service Information Recall	N/A
	Print	N/A
	Transmit Email	N/A
	Terminal Status	Maintenance
	Load Cell Detail (POWERCELL)	Maintenance
	Reset Terminal Status	Maintenance
<b>Information Recall Functions</b>		
	Weight Recall	N/A

Icon	Function	Security Access
<b>Calibration Test Functions</b>		
	Run Calibration Test	N/A
	Test Weight Information – Edit	Determined by setup
	Clear Test Weights	Supervisor
	Start Calibration Test	Entry of User ID required
	Test Information	N/A
	Skip (skips failed Calibration Test step and continues with the test)	N/A
	Print Calibration Test Report	N/A
<b>GWP® Test Functions</b>		
<b>GWP</b>	GWP Test Access	N/A
	Test Weight Information	Determined by setup
	Clear Test Weights	Supervisor
	Test Information	N/A
	Start	Entry of User ID required
	Skip (skips failed GWP Test step and continues with the test)	N/A
	Print GWP Test Report	N/A
<b>Tables, Counters, Printing Functions</b>		
<b>Alibi</b>	Alibi Memory - View	N/A
<b>Tables, Counters, Printing, Transfer Functions</b>		
	Print Alibi Memory	N/A
	Tare Memory (access the tare table)	N/A
	Target Memory (access the target table)	N/A

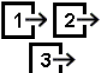
Icon	Function	Security Access
	View Table (access a table to view or retrieve a record)	N/A
	Search Table	N/A
	Select Record from Table	N/A
	Active Target - Edit	Supervisor
	Comparators – Edit	Supervisor
	Reports (recall and print reports for Alibi Memory, Tare Table, or Target Table)	N/A
	Clear Tare Table n & Totals	Supervisor
	Totals Recall	N/A
	Clear Subtotal	Supervisor
	Clear All Totals	Supervisor
	Print	Supervisor login required only if “Clear Totals on Print” is enabled.
	Transaction Counter	N/A
	Reset Transaction Counter	Supervisor
<b>Tables, Counters, Printing Functions</b>		
	Time & Date – Edit	Supervisor
	Repeat Print	N/A
	Customized Print Triggers 1, 2 and 3	N/A
<b>USB</b>	USB File Transfer	Refer to Table A-1 for file read/write access
<b>ID 1</b>	ID (initiates a programmed transactional sequence). ID1, ID2, ID3 and ID4 available.	N/A
<b>Display Functions</b>		
<b>x10</b>	Times 10 Display (expands the displayed weight by 10)	N/A



Icon	Function	Security Access
	SmartTrac (turns SmartTrac display off and on)	N/A
	MinWeigh – Edit	Supervisor
	Unit Switching	N/A
<b>Target Control Functions</b>		
	Target Control	N/A
	Start	N/A
	Pause	N/A
	Stop/Abort	Supervisor
<b>Task Selection Functions (only used with TaskExpert™ is installed)</b>		
	Task List – Displays list of assigned TaskExpert applications	N/A
<b>Task Selection Functions (only used with TaskExpert™ is installed)</b>		
	Task 1, 2, 3 – Starts TaskExpert application designated as Task 1, 2 or 3	N/A

**Table A-4: Security Access to Files Available For Transfer via USB Softkey**

File Type	Export*	Export Security Level	Import*	Import Security Level
Action Log (only available with Fill-570 application software)	Yes	Supervisor	No	N/A
Alibi Memory	Yes		No	N/A
Calibration Test and Weight Information	Yes		Yes	Maintenance
Change Log	Yes		No	N/A
Error Log	Yes		No	N/A
GWP Log	Yes		No	N/A
GWP Tests with Weight Information	Yes		Yes	Maintenance
InTouch	Yes		Yes	Supervisor
Terminal Status	Yes		No	N/A
Maintenance Log	Yes		No	N/A

<b>File Type</b>	<b>Export*</b>	<b>Export Security Level</b>	<b>Import*</b>	<b>Import Security Level</b>
Pac Statistics (only available when supporting application software is enabled in terminal)	Yes		No	N/A
Service Information Report	Yes		No	N/A
Table A1 (Tare)	Yes		Yes	Supervisor
Table A2 (Target)	Yes		Yes	Supervisor
Tables A0, A3 – A9	Yes		Yes	Supervisor

## A.3. Default Templates

Template 1			
Element	Data	Format	Data Description (not shown in template)
1	wt0101	[ 010]	Displayed Gross Weight
2	<sp>	[ 001]	-
3	wt0103	[003 ]	Primary Weight Units
4	CR/LF	1	-
5	ws0110	[ 010]	Displayed Tare Weight
6	<sp>	[ 001]	-
7	wt0103	[003 ]	Primary Weight Units
8	ws0109	[002 ]	Tare Source
9	CR/LF	1	-
10	wt0102	[ 010]	Displayed Net Weight
11	<sp>	[ 001]	-
12	wt0103	[003 ]	Primary Weight Units
13	N	[001 ]	String representing Net
14	CR/LF	2	-
15	-End-		-

Template 2			
Element	Data	Format	Data Description (not shown in template)
1	cs0103	[021 ]	Scale ID
2	CR/LF	1	-
3	xd0104	[015 ]	Time of Day
4	CR/LF	1	-
5	xd0103	[015 ]	Current Date
6	CR/LF	1	-
7	wt0101	[ 010]	Displayed Gross Weight
8	<sp>	[ 001]	-
9	wt0103	[003 ]	Primary Weight Units
10	CR/LF	1	-
11	ws0110	[ 010]	Displayed Tare Weight
12	<sp>	[ 001]	-
13	wt0103	[003 ]	Primary Weight Units
14	ws0109	[002 ]	Tare Source

Template 2			
Element	Data	Format	Data Description (not shown in template)
15	CR/LF	1	-
16	wf0102	[ 010]	Displayed Net Weight
17	<sp>	[ 001]	-
18	wf0103	[003 ]	Primary Weight Units
19	N	[001 ]	String representing Net
20	CR/LF	2	-
21	- End -		-

Templates 3 and 4			
Element	Data	Format	
1	- End -		-

Template 5			
Element	Data	Format	
1	Totals Report	[ 040 ]	String
2	CR/LF	1	-
3	xd0104	[020 ]	Time of Day
4	xd0103	[ 020]	Current Date
5	CR/LF	1	-
6	Subtotal:	--	String
7	CR/LF	1	-
8	n =	--	String
9	tz0104	--	Subtotal Transaction Counter
10	tz0103	[ 030]	Subtotal Weight
11	ce0103	[ 004 ]	Primary Units
12	CR/LF	1	-
13	Grand Total:	--	String
14	CR/LF	1	-
15	n =	--	String
16	tz0102	--	Grand Total Transaction Counter
17	tz0101	[ 030]	Grand Total Weight
18	ce0103	[ 004 ]	Primary Units
19	CR/LF	1	-
20	- End -		-

# B Table and Log File Structure

This appendix covers

- Alibi Memory
- Tare Table
- Target Table
- Change Log
- Maintenance Log
- Error Log
- PWRCL Performance Log
- GWP Log

The IND570 terminal includes an alibi memory file, a tare table, a target table, a change log file, a maintenance log file, an error log file and a GWP log file. Descriptions of each of these are included in this chapter.

## B.1. Alibi Memory

Alibi memory stores transaction information in a preset format that is not changeable. Alibi memory can be enabled or disabled in setup at **Application > Memory > Alibi**.

- The alibi memory operates by storing up to 600 alibi records in a battery-backed file as they occur. After this file is full, all of these records are written to the "alibi.bin" file in flash and the 600-record file is cleared and begins to store the next 600 records. The flash file (alibi.bin) can store up to 100,000 transactions before it rolls over and begins to overwrite the oldest file. Each record in the Alibi Memory file includes:
  - Date and time stamp fields
  - A transaction counter value, which is a unique numeric field that identifies the transaction (the transaction counter must be enabled in terminal setup to activate the transaction counter value)
  - Gross or net weight, tare weight, and weight unit



### B.1.1. Viewing Alibi Memory Records

Alibi memory records can be viewed in setup at **Application > Memory > Alibi** or through the Alibi softkey **Alibi** from the home screen. A report of all data in the Alibi Memory can be printed using the REPORTS softkey .

The content of the Alibi Memory can also be transferred as a .csv (comma separated value) file to a USB memory stick by accessing the file transfer function available through the **USB** softkey on the home screen. Refer to Chapter 2, **Operation**, for full details on transferring the Alibi Memory file to a USB memory stick.

#### B.1.1.1. To View Alibi Memory Records

1. Press the REPORTS softkey  or the Alibi softkey **Alibi**.

- If the REPORTS softkey  was pressed, select Alibi Memory from the selection box. Press the VIEW TABLE softkey  shown at the bottom of the screen. The Search Screen displays (Figure B-1). If the home screen ALIBI softkey **Alibi** was pressed instead of the REPORTS softkey , the Search Screen will appear directly. Figure B-1 shows the first of two screens. The second contains Search Field 2 and its associated data fields. Note the scroll bar at right, indicating the availability of a second screen.



**Figure B-1: Alibi Search Screen**

- Use the Search Field 1 and Search Field 2 selection boxes and associated data fields to enter specific search information to limit the search, or use the default “find all” character, the asterisk (\*) to view all records.
- Press the SEARCH softkey . The Alibi Memory Search View screen displays with the search results sorted in chronological order. The most recent record will appear at the end of the list, and that record will be in focus. Only the first two fields (date and time) will be shown on the display. The remainder of the fields in each record can be viewed by pressing the RIGHT navigation key to move the view to the right. Pressing the LEFT navigation key will return the view toward the left. Figure B-2 includes a series of screens to show the contents of further columns available in the view.

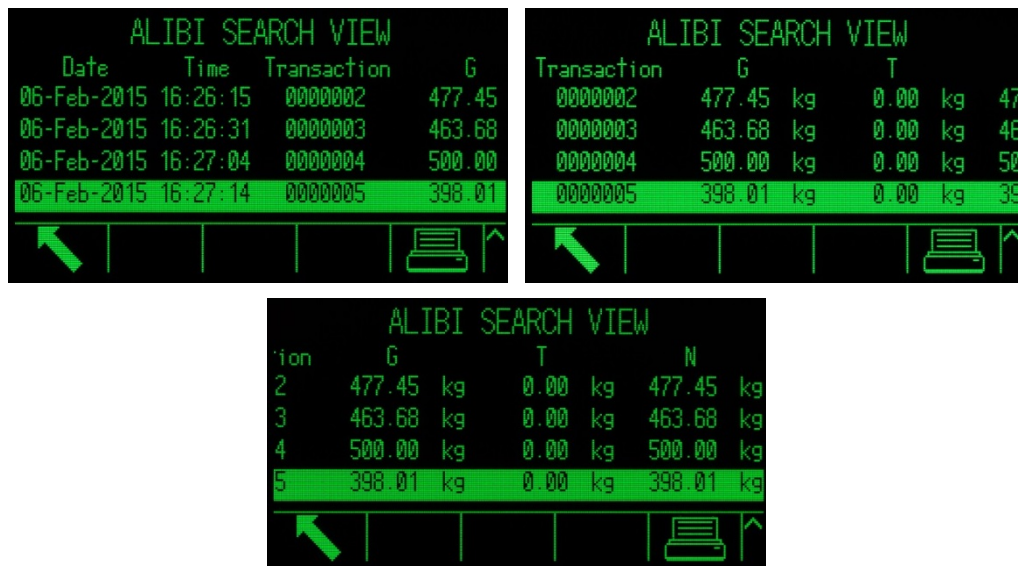

**Figure B-2: Alibi Search Results Views**

The Alibi Memory cannot be cleared manually. It is automatically cleared after it has been disabled and enabled again.



## B.2. Memory Tables

### B.2.1. Tare Table

The IND570 terminal contains a tare table with 99 records for storing tare weights that can be recalled by the operator for use instead of manually entering them for each transaction. This recall function is especially useful when certain tare values are used repeatedly. When totalization is enabled for the tare table, each time a transaction is completed using an activated tare ID, the selected weight value (gross or net weight) is added to the total and the counter increments by one.

For gross weight accumulation, the tare table can be used with tare values of 0 in order to accumulate weight by tare ID.

The counter for the tare totals is seven digits long and has a maximum value of 1,500,000. When this value is exceeded, an overflow error displays and that value is not accumulated. The counter must be reset in order to continue totalizing. The total register is 11 digits in length including all positions to the right of the decimal point. The decimal position is determined by the display resolution for the unit entered as the tare unit. The maximum value for a scale with a display resolution of 0.01 kg would be 999999999.99 kg. When this value is exceeded, an overflow error displays and that value is not accumulated. The total must be reset in order to continue totalizing.

These tare weights can be recalled by either selecting from a list of all the values using the TARE TABLE softkey  followed by the SEARCH softkey  or can be "quick accessed" directly by pressing the Tare ID value followed by the TARE TABLE softkey . Alternatively, the Shared Data server can be used to activate tare records stored in the Tare Table. Refer to the **Shared Data Access** section of Appendix C, **Communications** for specific instructions.

A printed report of the records in the Tare Table is available through the REPORTS softkey . This procedure is explained later in this chapter. The content of the Tare Table is available as a .csv (comma separated value) and can be transferred to a USB memory stick by accessing the file transfer function available through the **USB** softkey on the home screen. Refer to Chapter 2, **Operation**, for full details the USB file transfer function.

The structure of a tare record is shown in Table B-1.



**Table B-1: Tare Records Stored in the Tare Table**

Field	Length	Type	Description
ID	2	Numeric	Numeric string used for tare record lookup
Tare Weight	8	Numeric	Tare value. Stored in display resolution.
Tare Units	3	Alpha	Tare weighing units (dwt, g, kg, lb, oz, ozt, t, ton)
Description	20	Alphanumeric	Description of this tare value
Total Weight	8	Numeric	Total weight of transactions completed using this stored tare record
Total Count	8	Numeric	Total number of transactions using this stored tare record.

## B.2.2. Target Table

The IND570 contains a 200-record Target Table that stores frequently used target-comparison values. The fields in the record will depend upon the operating mode of the Target Table, Tolerance Type and Totalization settings as selected in setup at **Application > Memory > Target Table**. There are two choices for the mode – Material Transfer or Over/Under. There are either two or three choices for the tolerance type, depending upon the target mode selection. Totalization can be enabled or disabled.

When totalization is enabled for the target table, each time a transaction is completed using an activated target ID, the selected weight value (gross or net weight) is added to the total and the counter increments by one.

A target table record can be recalled by picking from a list of all the values using the TARGET TABLE softkey  followed by the SEARCH softkey . It may be also be “quick accessed” directly by entering the Target ID value followed by the TARGET TABLE softkey . Alternatively, the Shared Data server can be used to activate tare records stored in the Tare Table. Refer to the **Shared Data Access** section of Appendix C, **Communications** for specific instructions.

A printed report of the records in the Target Table is available through the REPORTS softkey . This procedure is explained later in this chapter. The content of the Target Table is available as a .csv (comma separated value) and can be transferred to a USB memory stick by accessing the file transfer function available through the **USB** softkey on the home screen. Refer to Chapter 2, **Operation**, for full details the USB file transfer function.

The possible fields for a target record are shown in Table B-2. Not all fields will be used for all combinations of Operating Mode and Tolerance Type.



**Table B-2: Target Records Stored in the Target Table**

Field	Length	Type	Description
ID	2	Numeric	Numeric string used for target record lookup
Target weight	8	Numeric	Target value to be used for the comparison
Target units	3	Alpha	Target weighing units (dwt, g, kg, lb, oz, ozt, t, ton)
+ Tolerance or Over Limit	8	Numeric	Acceptable tolerance over the target weight or maximum acceptable weight
– Tolerance or Under Limit	8	Numeric	Acceptable tolerance under the target weight or minimum acceptable weight
Fine Feed	8	Numeric	Amount of material that will be fed in the slower rate of feed in a 2-speed feed system
Spill	8	Numeric	Amount of material in suspension that will add to the weight after all feeds are shut off
Description	20	Alphanumeric	Description of the target record
Total Weight	8	Numeric	Total weight of transactions completed using this stored target record
Total Count	8	Numeric	Total number of transactions using this stored target record.





The target record is recalled in the same way regardless of the mode or tolerance type selected in setup.

### B.2.3. Selecting a Tare or Target Record

In order to search and select a tare record from the tare or target table, the TARE TABLE softkey  and/or TARGET TABLE softkey  must be added to a softkey row on the home screens.

#### B.2.3.1. To Access the Tare or Target Table

1. Press the TARE TABLE softkey  or TARGET TABLE softkey  to display the search screen as shown in Figure B-3.

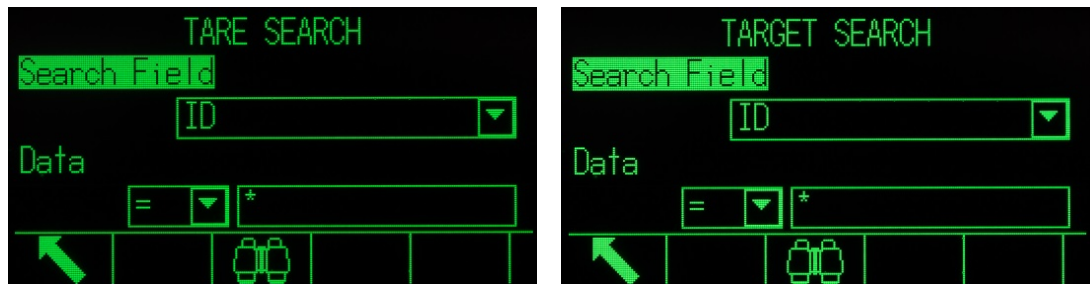



Figure B-3: Tare Table and Target Table Search Screen

2. Use the Search Field selection boxes and associated data fields to enter specific search information to limit the search, or use the default "find all" character, the asterisk (\*) to view all records.
3. Press the SEARCH softkey . The table Search View screen displays with the search results sorted by ID. The file will have the lowest record ID at the top of the file and focus will be on that record. Press the RIGHT navigation key to move the view to the right to view the full record. Figure B-4 and Figure B-5 include screens to show the contents of further columns available in the view.

ID	Tare	Description
01	1.36	kgBox #10
02	3.18	kgBox #23 with Foil
03	10.23	kgPallet A size
04	8.16	kgPallet B size
05	2.72	kgBox #23 with AL DET

Description	n	Total
#10	46	2780.29
#23 with Foil	217	19462.00
let A size	25	4865.50
let B size	50	11190.65
#23 with AL DET	105	15580.00

Figure B-4: Tare Table Search View Results

ID	Description	Target	Unit
001	BXK-22P	650	
002	BTL #448 XP43	575	
003	PLT #523 XX98	580	
004	STRD #650 XM47	720	

Target	Units	Spill	+Tol
650	kg	27	
575	kg	29	
580	kg	32	
720	kg	18	

Units	Spill	+Tol	-Tol	Fine
kg	27	6.5	4.88	28950
kg	29	5.75	4.3	115800
kg	32	5.8	4.35	188175
kg	18	7.2	5.4	332925

Figure B-5: Target Table Search View Results

- Use the UP and DOWN navigation keys to focus on a record.
- Press the OK softkey to use that record. The stored tare value or target values is recalled from the table and is used as the active value.
  - Note:** A value stored in the tare table is automatically converted when recalled if the units of the record do not match the current displayed units.
  - Note:** If second and/or third units are established in the IND570, target records that utilize either second or third units can be retrieved from the Target Table into Active Target status. The IND570 will convert the retrieved record into active units when the record is recalled. Pressing the TARGET softkey will show the original units as recalled from the Target Table.

If an attempt is made to retrieve a record from the Target Table that does not use primary, second or third units, a **Units Mismatch** error will display, indicating that record recall was unsuccessful.

## B.2.4. Quick Access



If the ID number for a specific record in the Tare or Target Table is known, the record can be quickly recalled for use without going through the view and selection process.

### B.2.4.1. To Quickly Access a Specific Tare or Target Table Record

1. Use the numeric keypad to enter the numeric ID for the table record that is to be used. The data entry screen displays as shown in Figure B-6.



Figure B-6: Data Entry Screen

2. Press the TARE TABLE softkey  or TARGET TABLE softkey  to quickly recall the ID record entered. The stored tare value or target values is recalled from the table and is used as the active value.
3. If an invalid ID number is entered, an **ID not found** message displays.
  - **Note:** When a value stored in the tare table is recalled, it is converted automatically if its units do not match the current displayed units.
  - **Note:** If second and/or third units are established in the IND570, target records that utilize either second or third units can be retrieved from the Target Table into Active Target status. The IND570 will convert the retrieved record into active units when the record is recalled. Pressing the TARGET softkey  will show the original units as recalled from the Target Table.
4. If an attempt is made to retrieve a record from the Target Table that does not use primary, second or third units, a **Units Mismatch** error will display indicating that record recall was unsuccessful.





## B.2.5. Clearing Totals

All the records in the Tare Table can be cleared by pressing the CLEAR softkey **C** when viewing the first setup page for the table at **Application > Memory > Tare Table**.

The totals for all of the records in the Tare Table can also be cleared by pressing the REPORTS softkey , selecting Tare Table from the selection box, and pressing the CLEAR TOTALS softkey **C\***.

All the records in the Target Table can be cleared by pressing the CLEAR softkey **C** when viewing the first setup page for the table at **Application > Memory > Target Table**. To just clear the totals in the Target Table, press CLEAR TOTALS softkey **C\***.

**B.2.5.1. To Clear the Total Value of an Individual Record**

1. Access the setup menu tree and select either **Application > Memory > Tare Table** or **Target Table**.
2. Press the VIEW TABLE softkey . The Search screen (Figure B-3) displays.
3. Use the Search Field selection boxes and associated data fields to enter specific search information to limit the search, or use the default "find all" character, the asterisk (\*), to view all records.
4. Press the SEARCH softkey . The table Search View screen (Figure B-4 and Figure B-5) displays with the search results sorted by ID.
5. Use the UP and DOWN navigation keys to highlight the tare record for which the total is to be cleared and press the EDIT softkey . The record Edit screen displays.
6. Press the DOWN navigation key to highlight the **n** and **Total** label and press ENTER.
7. Clear the **n** and/or **Total** values by pressing the CLEAR key on the numeric keypad when focus is in that data entry box. When the value in the data entry box is clear, press ENTER.
8. Press the OK softkey  to accept the changes.
9. Use the EXIT softkey  to return to the home screen.

**B.3. Log Files****B.3.1. Change Log File**

The Change Log in the IND570 terminal file tracks all changes to shared data. The Change Log can be enabled or disabled in setup at **Maintenance > Configure/View > Change Log**.

The Change Log file is a linear-type file that eventually becomes full if not reset. It will hold an estimated 2,500 records. When the file becomes 75% full, a warning message displays indicating the status. Another message displays when the file is 90% full. If the file is not reset, it will continue to store records until it is 100% full and a final 100% full message displays. Additional changes to shared data will not be recorded until the file is reset.

The Change Log file is available as a comma separated value file (change.csv) that can be exported to a USB memory stick using the **USB** softkey on the home screen or via FTP to a client PC. The variable length Change Log record structure and an example are as follows:

Timestamp , Username , SDName , Value

2015/02/11 09:45 , System , ce0102 , "91" <CR><LF>

2015/02/11 09:46 , System , sp0105 , "25.85" <CR><LF>

### B.3.1.1. Viewing Change Log File Records

The Change Log records can be viewed in setup at **Maintenance > Configure/View > Change Log**.

1. Access the setup menu tree and select **Maintenance > Configure/View > Change Log**.
2. Press the VIEW TABLE softkey . The Log Search screen displays (Figure B-7). Note the scroll bar, indicating that a second screen is available. Scroll down to see Search Field 2 and its associated data fields.





**Figure B-7: Change Log Search Screen**

3. Use the Search Field 1 and Search Field 2 selection boxes and associated data fields to enter specific search information to limit the search, or use the default “find all” asterisk character (\*) to view all records.
4. When the search criteria are set, press the SEARCH softkey . The Log Search View screen (Figure B-8) displays with the search results sorted in chronological order (the oldest record displays first). Additional columns of data (User name, Shared Data name, New Value) may be viewed by scrolling to the right.

Date	Time	Username	SD
06-Feb-2015	17:47:07	admin	cm0144
06-Feb-2015	17:47:07	admin	cm0150
06-Feb-2015	17:47:07	admin	cm0156
06-Feb-2015	17:47:07	admin	cm0157

**Figure B-8: Log Search View Screen**

5. If a Report connection has been configured, the PRINT softkey  can be used to print the current view.
6. Press the EXIT softkey  to return to the Log Search Screen.

### B.3.2. Maintenance Log File

A Maintenance Log can be enabled or disabled in setup at **Maintenance > Configure/View > Maintenance Log**.

The Maintenance Log file is a ring-type file that overwrites the oldest record when it becomes full. It will hold an estimated 2,500 records. The Maintenance Log tracks and logs service operations that

are performed on the IND570. The items logged include functions such as calibration and file exports.

The Maintenance Log file is available as a comma separated value file (maint.csv) that can be exported that can be exported to a USB memory stick using the **USB** softkey on the home screen or via FTP to a client PC. The Maintenance Log record structure and an example are as follows:

Timestamp , Username , Channel , Cell , Event Code , Status

2015/02/11 , 09:45 , System , 01 , [blank] ,02 , SUCCESS<CR><LF>

A complete list of the possible maintenance event codes for the IND570 terminal is listed in Table B-3.



**Table B-3: Maintenance Log Event Codes and Status**

Event	Description	Status Code(s)
1	Calibration test failed	1-n = failed at step n.
2	Zero calibration performed	FAILURE, SUCCESS, Motion
3	Span calibration performed	FAILURE, SUCCESS, Motion
4	CalFree calibration performed	FAILURE, SUCCESS
5	POWERCELL cell Shift Adjust	FAILURE, SUCCESS
6	POWERCELL cell Address	FAILURE, SUCCESS
8	Log file exported via FTP	Maintenance, Change, TACT (Action), Alibi
9	Setup file exported - .dmt files exported via FTP	SUCCESS
10	Metrology switch / electronic seal broken	SUCCESS
11	Calibration Expired	1=days 2 =weightments
15	Added option component	Manual text entry
16	Removed option component	Manual text entry
17	Replaced component	Manual text entry
18	Maintenance Log initialized	SUCCESS
19	Calibration values manually edited	SUCCESS
20	Shift values manually edited	SUCCESS
21	Set date or time	SUCCESS
22	Table exported	tare, target, cont, caltw1, caltest1, sentw1, sentest1, ecctw1, ecctest1, reptw1, reptest1
23	Calibration test passed	SUCCESS
28	Successful zero command	
42		
43	Sensitivity test failed	1-n = failed at step n

Event	Description	Status Code(s)
44	Sensitivity expired	1 = Days 2 = Weighments
45	Sensitivity test passed	SUCCESS
46	Eccentricity test failed	1-n = failed at step n
47	Eccentricity expired	1 = Days 2 = Weighments
48	Eccentricity test passed	SUCCESS
49	Repeatability test failed	1-n = failed at step n
50	Repeatability expired	1 = Days 2 = Weighments
51	Repeatability test passed	SUCCESS
52	File exported via USB	ALIBI, MAINT, CHANGE, GWPLOG, SVRINFO, TERMST, AO, tare, target, A3, A4, A5, A6, A7, A8, A9, CALTW1, CALTST1, SENTW1, SENTST1, ECCTW1, ECCTST1, REPTW1, REPTST1, RunCal, SYSINFO, RunSens, RunEcc, RunRep, GWPLOG, ERRLOG, SVCINFO
53	File imported via USB	AO, tare, target, A3, A4, A5, A6, A7, A8, A9, CALTW1, CALTST1, SENTW1, SENTST1, ECCTW1, ECCTST1, REPTW1, REPTST1,CONT,
54	Firmware updated via USB	SUCCESS, FAILURE
55	Step calibration performed	SUCCESS, FAILURE

### B.3.2.1. Viewing Maintenance Log File Records



The Maintenance Log records can be viewed in setup at **Maintenance > Configure/View > Maintenance Log**.

1. Access the setup menu tree and select **Maintenance > Configure/View > Maintenance Log**.
2. Press the VIEW TABLE softkey . The Maintenance Log Search screen displays (Figure B-9).
3. Use the Search Field 1 and Search Field 2 selection boxes and associated data fields to enter specific search information to limit the search, or use the default "find all" asterisk character (\*) to view all records.
4. When the search criteria are set, press the SEARCH softkey . A Log Search View screen like the one shown in displays with the search results sorted in chronological order (oldest record displays first). Press the RIGHT navigation key to move the view to the right to view the full log content.

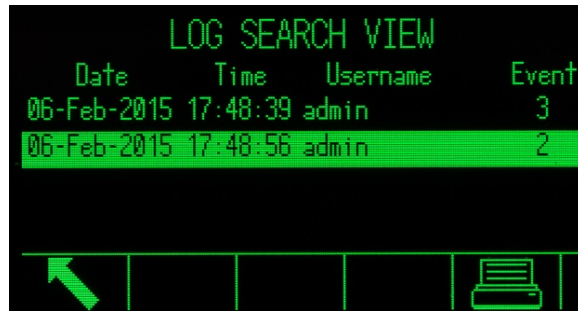



**Figure B-9: Maintenance Log Search Screen**

5. If a Report connection has been configured, the PRINT softkey  can be used to print the current view.
6. Press the EXIT softkey  to return to the Maintenance Log Search Screen.

### **B.3.3. GWP Log File**

The GWP Log records the final, basic results of Calibration, Sensitivity, Reproducibility and Eccentricity tests performed in the terminal. The GWP Log is a ring-type file that overwrites the oldest record when it becomes full. It will hold an estimated 2,500 records.

The GWP Log file is available as a comma separated value file (gwp.csv) that can be exported that can be exported to a USB memory stick using the **USB** softkey on the home screen or via FTP to a client PC. The GWP Log record structure and an example are shown below:

Timestamp , User ID , GWP Test , Warning Limit Status , Test Status

2015/02/11 , 09:45 , Jocefowicz , Repeatability , Passed , Passed<CR><LF>

### **B.3.4. Error Log File**

The Error Log records the details of system errors. The Error Log file is available as a comma separated value file (error.csv) that can be exported that can be exported to a USB memory stick using the **USB** softkey on the home screen or via FTP to a client PC. The Error Log can hold up to 500 records. The Error Log record structure and an example are shown below:

Timestamp , Severity , Error Code , Detail , Message

2014/04/10 , 13:34:23 , E , 00002 , [ ] , RAM Battery Voltage Low<CR><LF>

- **Note:** The Detail field is a counter that tracks the number of times an error or event occurs consecutively over a period of time. This is not a count of the total number of times an error occurs.

### **B.3.5. POWERCELL Performance Log**

The POWERCELL Performance Log provides a summary of the performance and diagnostics data collected for each cell on a POWERCELL scale. The items logged include data such as load cell raw counts, cell error counters, cell voltages and temperature.



The POWERCELL Performance Log can be set to record data automatically in Setup at **Maintenance > Configure/View > PWRCL Performance Log**. The Log is a FIFO file that overwrites the oldest record when it becomes full. It will hold approximately 500 individual records. If the file is not reset, it will continue to store records until it is 100% full and then begin overwriting the oldest records.

### B.3.5.1. Viewing PWRCL Performance Log File Records

Only a METTLER TOLEDO authorized service representative can retrieve the POWERCELL Performance Log records. The log file can be accessed as a comma-separated value (.csv) file, downloaded using any FTP client PC, the USB softkey or with the Backup to USB feature.

### B.3.5.2. To View the POWERCELL Performance Log File

1. The POWERCELL Performance Log does not automatically log records by default. To set up the automatic logging, go to the **Maintenance > Configure/View > PWRCL Performance Log** setup screen (Figure B-10) and enter an appropriate log interval, between 0.1 and 999.9 hours. A typical value for day-to-day operation is 12, but for diagnostic purposes this interval can be much smaller. A manual record can also be triggered using the **PWRCL PERFORMANCE LOG** softkey  $\Rightarrow$  PWRCL.

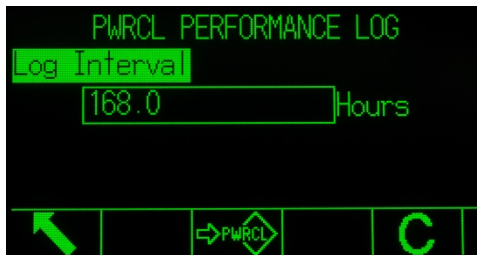

Figure B-10: PWRCL Performance Log Setup Screen

2. To retrieve the log records, the MT Service Security feature must be unlocked. Refer to the MT Service Security section in Chapter 3 for the unlocking procedure.
3. Once the MT Service Security is unlocked, use either the USB softkey, InSite, an FTP client PC, serial file transfer or the Backup to USB feature to access the log file. If using the FTP client or the serial file transfer, refer to Appendix C, **Communications** for information on accessing the terminal's files. The file and path name for the log is gen:/PWRCL\_PER.CSV.
4. The .csv file can be opened using a PC program such as MS Excel, as shown in Figure B-11.

1	A	B	C	D	E	F	G	H	I	J	K	L	M	N	O	P	Q	R	S											
2	Date	Time	Node	Serial Number	Cell Count	Com Error	Min	Suppl	Last	Suppl	CanH	Dom	CanL	Rec	CanL	Rec	Major	Over	Major	Undi	Minor	Over	Undi	Temperatu	Current	Te	Max	Temp	M	
2	6-Feb-09	13:21:23	4	7279010245	10949	0	11556	11627	3658	1298	0	2411	0	0	0	45	0	-1694	-419											
3	6-Feb-09	13:21:23	3	7279010247	9673	0	11521	11556	3636	1276	2389	2389	0	0	0	45	0	-1768	-419											
4	6-Feb-09	13:21:23	2	7279010128	9431	0	11485	11556	3658	1298	2411	2411	0	0	0	45	0	-1821	-419											
5	6-Feb-09	13:21:23	1	7279010446	159107	0	11485	11556	3681	1343	2434	2434	0	0	0	45	1	-1764	-419											
6	6-Feb-09	11:54:25	4	7279010245	10924	0	11556	11627	3658	1298	0	2411	0	0	0	45	0	-1694	-419											
7	6-Feb-09	11:54:25	3	7279010247	9674	0	11521	11592	3636	1276	2389	2389	0	0	0	45	0	-1768	-419											
8	6-Feb-09	11:54:25	2	7279010128	9426	0	11485	11592	3658	1298	2411	2411	0	0	0	45	0	-1821	-419											
9	6-Feb-09	11:54:25	1	7279010446	162991	0	11485	11592	3681	1343	2434	2434	0	0	0	45	1	-1764	-419											
10	6-Feb-09	11:46:36	4	7279010245	10917	0	11556	11627	3658	1298	0	2411	0	0	0	45	0	-1694	-419											
11	6-Feb-09	11:46:36	3	7279010247	9673	0	11521	11592	3636	1276	2389	2389	0	0	0	45	0	-1768	-419											
12	6-Feb-09	11:46:36	2	7279010128	9424	0	11485	11592	3658	1298	2411	2411	0	0	0	45	0	-1821	-419											
13	6-Feb-09	11:46:36	1	7279010446	127654	0	11485	11592	3681	1343	2434	2434	0	0	0	45	0	-1763	-419											
14	6-Feb-09	11:42:16	4	7279010245	10916	0	11556	11627	3658	1298	0	2411	0	0	0	45	0	-1694	-419											

Figure B-11: PWRCL Performance Log

5. By default the records are sorted by time and date, with the most recent showing first. Each record row represents the data collected for a specific cell node.

### B.3.6. Resetting the PWRCL Performance Log File

The Log is cleared each time a Master Reset is performed. It can also be manually reset in setup.

#### B.3.6.1. To Reset the File Manually

1. Access the **Maintenance > Configure/View > PWRCL Performance Log** setup screen (Figure B-10).
2. Press the CLEAR softkey **C** to clear the log records and reset the log file. A warning screen is shown, requesting verification. Press the ESCAPE softkey **Esc** to cancel the operation or the OK softkey **OK** to confirm it.
3. A status message displays, verifying that the reset was completed.

### B.3.7. PWRCL Performance Log File Structure

The PWRCL Performance Log file is available as a comma separated value (.csv) file. The file includes a header row with the fields as described in Table B-4. Each row of the file is one record and each record is one set of the data captured for each load cell connected to the terminal.

**Table B-4: PWRCL Performance Log Data Fields**

Data Field	Description
Date	Date when the record was generated.
Time	Time when the record was generated.
Node	POWERCELL cell node address.
Serial Number	The unique factory serial number embedded in the cell.
Cell Counts	Load cell counts at the time the record was generated.
Com Errors	Total number of cell communication errors.
Min Supply Voltage	Minimum cell input supply voltage measured in millivolts.
Last Supply Voltage	Last measured cell input supply voltage in millivolts.
CanH Dominant Voltage	Cell CAN-High voltage recorded for Dominant mode in millivolts. <sup>1</sup>
CanL Dominant Voltage	Cell CAN-Low voltage recorded for Dominant mode in millivolts. <sup>1</sup>
CanH Recessive Voltage	Cell CAN-High voltage recorded for Recessive mode in millivolts. <sup>1</sup>
CanL Recessive Voltage	Cell CAN-Low voltage recorded for Recessive mode in millivolts. <sup>1</sup>
Major Overvoltage Count	Total number of severe or long term over-voltage events detected by the IND570 for all connected cells. Possible causes include a near lightning strike or a short circuit.
Major Undervoltage Count	Total number of severe or long term under-voltage events detected by the IND570 for all connected cells. Possible causes include a near lightning strike or an overloaded supply.
Minor Overvoltage Count	Total number of intermittent over-voltage events detected by the IND570 for all connected cells. Possible causes include a distant lightning strike or a short circuit.



Data Field	Description
Minor Undervoltage Count	Total number of intermittent under-voltage events detected by the IND570 for all connected cells. Possible causes include a distant lightning strike or an overloaded supply.
Temperature Deviation	The deviation in cell temperature since last scale calibration, calculated by subtracting the current temperature from the temperature at time of calibration.
Current Temperature	The current temperature sensor reading in the cell.
Maximum Temperature	Maximum cell temperature recorded.
Minimum Temperature	Minimum cell temperature recorded.
Gas Concentration	Current level (%) of inert gas concentration enclosed in the cell.
Zero Drift Errors	Total number of cell zero drift errors.
Zero Drift Value	Current cell zero drift value in primary weight units.
Cell Overloads	Total number of cell overload errors.
Average Overload Weight	The weight value detected by the cell and recorded as an average each time it is overloaded. In primary weight units.
Symmetry Errors	Total number of cell symmetry drift errors.
Symmetry Difference	Current cell symmetry difference (%) value.
Total Transactions	Total number of print transactions for a specific scale.

#### Note

1. These values are stored from the last time the Load Cell COM Voltage Screen was accessed.

## B.4. Resetting Log Files

All Log files are reset when a Master Reset is carried out. Log files can also be manually reset in setup.

1. Enter the menu tree and go to the **Maintenance > Configure/View**. Enter into the sub-branch of the Log file to be reset.
2. Press the RESET softkey  (or, in the POWERCELL version, the CLEAR softkey ) to reset the log file. A screen displays that asks for verification. Press the OK softkey  to continue. A status message displays verifying that the reset was successful.

# C Communications

This appendix covers

- Available Communication Interfaces
- Logical/User-Definable Connections
- Inputs
- Output Templates
- Communication Outputs
- Continuous Output Mode
- Standard Interface Command Set (SICS)
- Remote Discrete I/O (ARM100)
- Report Printing
- Shared Data Access
- FTP
- Remote Display

This appendix provides descriptions of the physical connections available in the IND570 terminal as well as the logical connections that can be defined to use them. Additional details are provided on all available communication modes (Demand and Continuous) and supported communication protocols and input command functions.

## C.1. Available Communication Interfaces

The IND570 supports data transfer via serial ports, Ethernet ports and a USB Host port. Broad data communication via various PLC interfaces is also supported, but not covered in this appendix. Please refer to the **IND570 PLC Interface Manual** for additional information on PLC communication available with the IND570.

### C.1.1. Serial Interfaces

One or two standard and two optional serial ports are supported with the IND570 terminal. They are designated COM1 (standard port on the main PCB), COM2 (optional), COM3 (optional) and COM4 (standard on POWERCELL version).

**COM1**, a standard serial port on the main board, provides RS-232, RS-422, and RS-485 interfaces at communication rates from 300 to 115.2k baud. The RS-232 interface is a three-wire (TDX, RXD, and GND) with XON/XOFF flow-control capabilities (handshaking). The RS-422 interface is a four-wire interface designed for single point-to-point communication. The RS-485 connection is a two-wire interface but does not provide multi-drop communication with addressing. All interfaces can be output simultaneously; however, only one input can be used. The COM1 port is unique in that it can be used to load firmware into the IND570 and provides access to the shared data server. In the POWERCELL version, COM1 and COM4 are electrically isolated.

**COM2**, only available on the COM2/COM3 serial option or COM2/COM3/DIO option, provides only an RS-232 interface at communication rates from 300 to 115.2k baud. This interface is a three-wire connection with XON/XOFF handshaking capabilities.

**COM3**, only available on the COM2/COM3 serial option or COM2/COM3/DIO option, provides RS-232, RS-422, and RS-485 interfaces at communication rates from 300 to 115.2k baud. ON/XOFF handshaking is supported.

**COM4**, only available in the POWERCELL version, provides an isolated RS-232 interface at communication rates from 300 to 115.2k baud. This interface is a three-wire connection with XON/XOFF handshaking capabilities.

For all serial connections, character framing is programmable in the setup mode. Framing can be:

- 1 start bit
- 7 or 8 ASCII data bits (selectable)
- 0 or 1 parity bit (none, even, or odd)
- 1 stop bit

The baud rate can be configured from 300 to 115.2K baud. A checksum character can also be configured when using one of the continuous output strings.

The IND570 terminal uses software handshaking to control data flow commonly referred to as XON/XOFF handshaking. When a receiving device (typically a printer) is getting information from an IND570 terminal and cannot receive any more in its buffer, it sends an ASCII XOFF (13h) telling the IND570 terminal to temporarily stop sending data until its buffer clears.

When the device can receive more data, it sends an ASCII XON (11h) telling the IND570 terminal to begin sending data again. This process can occur as often as required by a receiving device.

The XON/XOFF method is the only type of handshaking that is supported by the IND570 terminal.

### C.1.2. Ethernet

The optional Ethernet port on the IND570 provides an RJ45 connector. The port supports Auto-MDIX allowing automatic detection of the Ethernet cable type being used (patch/straight-through or crossover) and will adjust to make a link over that cable.

Speeds of 10 Mb/s and 100 Mb/s are possible utilizing 10 Base-T, 100 Base-TX, 100 Base-FX, and 100 Base-T4 connections to an Ethernet network. The port is fully compliant with IEEE standard 802.3 and 802.3x. Full duplex flow control and half duplex back pressure communication are supported.

Up to 3 clients can be connected to the IND570 at a time. The Ethernet port can be used for the following functions:

- Shared data access
- Demand output
- Continuous output
- FTP

- Sending email notifications

### C.1.2.1. Ethernet Connection to a PC

The optional Ethernet port for the IND570 provides a way to interface a PC to the IND570 to transfer a variety of information. In order to carry out data transfer functions, the IND570 (with optional Ethernet) must be connected directly to a PC or to a network switch with an Ethernet cable. The IP addresses of both devices must be in agreement as shown in Figure C-1.

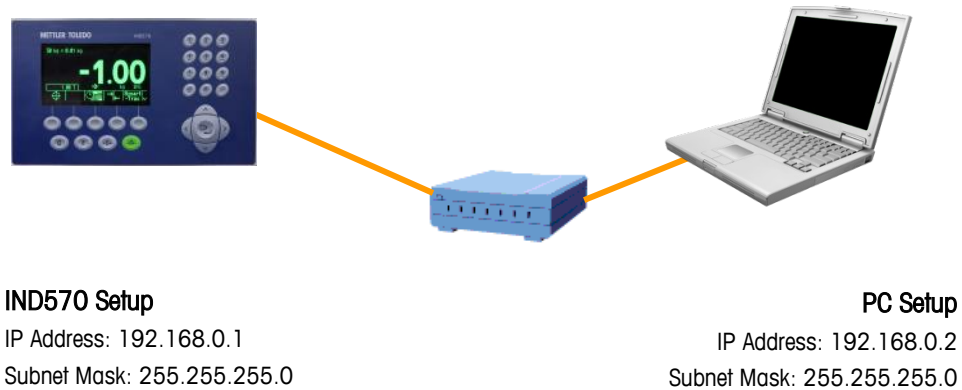

**Figure C-1: IP Address Configuration Example**

If both the IND570 and the PC are connected to the same facility network and both are using DHCP to obtain an IP address, it is likely that appropriate IP addresses will be assigned to both devices so that the IND570 can communicate with the PC through the network.

However, there may be situations where direct connection between a PC and the IND570, outside of a network is desired. In these situations, each device will need a static IP assigned that meets the addressing criteria shown in Figure C-1. Refer to Chapter 3, **Configuration**, for information on programming a static IP address in the terminal.

An example of how to configure a static IP address and subnet mask in a PC running Microsoft Windows 7 is shown in Figure C-2 and Figure C-3:

1. Open Network Connections by clicking the **Start** button , and then clicking **Control Panel**.
2. In the search box, type **adapter**. Under Network and Sharing Center, click **View network connections**.
3. Right-click **Local Area Connection**, and then click **Properties**. If you're prompted for an administrator password or confirmation, type the password or provide confirmation.
4. Click the **Networking** tab. Under **This connection uses the following items**, click **Internet Protocol Version 4 (TCP/IPv4)**. Click **Properties**.

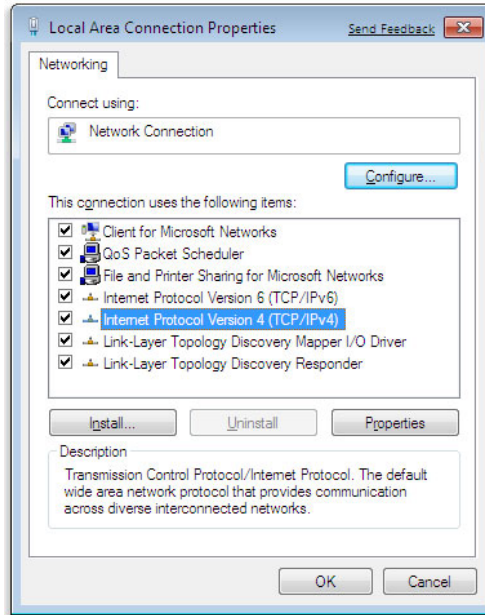

**Figure C-2: Local Area Connection Properties Screen**

5. Typically, "Obtain an IP address automatically" is checked. However, to connect to the IND570, set a specific PC IP address and subnet mask by clicking **Use the following IP address**. In the **IP address**, **Subnet mask**, and **Default gateway** boxes, type the IP address settings.

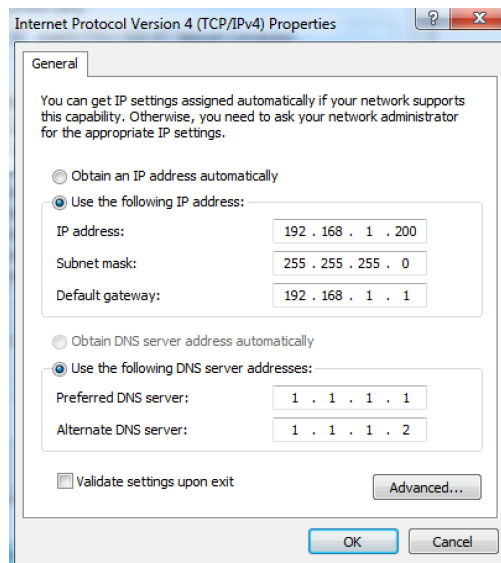

**Figure C-3: Internet Protocol (TCP/IP) Properties Screen**

6. Click on the OK button.
  - After disconnecting from the IND570 and before connecting back to the PC's normal network connection, remember to change the Internet Protocol (TCP/IP) Properties Screen setting back to "Obtain an IP address automatically" or to whatever setting was active when the screen was accessed.

### C.1.3. USB Host

IND570 provides a standard USB port classified as 2.0 Full Speed (12 Mbps/1.5 Mbps) host HID class and mass storage class. The USB port has an A type receptacle and provides +5V at a minimum of 100mA for connected devices.

- Only FAT and FAT32 USB flash drive formats are supported
- The maximum supported USB flash drive memory size is 32 GB
- Multiple devices can be connected simultaneously through an external USB hub
- Direct connection from IND570 to a printer or PC for data transfer is not supported.

Full details on enabling the USB port for use and all associated functions can be found in Chapter 2, **Operation, USB Host**.

	 <b>WARNING</b>
<b>THE USB INTERFACE IS NOT CERTIFIED FOR USE IN DIVISION 2 OR ZONE 2/22 HAZARDOUS AREAS. USE ONLY IN SAFE AREA.</b>	

#### C.1.3.1. USB Barcode Scanners

Table C-1 lists several USB barcode manufacturers and models that have been tested and confirmed to work with the IND570.

**Table C-1: USB Barcode Brands/Models with Confirmed Performance**

Brand	Model
DataLogic	GRYPHON GM4100-BK-433MHz OM-GRYPHON USB 433MHz(Base) & GRYPHON M130 (reader) GRYPHON GD4130-BK Quick Scan M2, Type: 130 (wireless) Powerscan D8330 GRYPHON GM4401-BK-910mHz (PegaDISCRETE - wireless) Heron-G D130
Symbol	STB3578 LS2208-SR20001 LS2208-SR20007 DS6878-SR20007WR LS4200
HoneyWell	MS5145 1900GHD-2 1900GSR-2USB
HandHeld	3800LTP-12E 4600GSF 051CE



### C.1.3.2. External Keyboard Mapping

The selection of the proper language type for the keyboard enables correct access to the layout of specific language keyboards. Refer to the **Terminal | Region | Language** section of Chapter 3, **Configuration** for details on setting the external keyboard language.

The IND570 supports use of the keyboard NUM LOCK, allowing use of the numeric keypad. External keyboard mapping to IND570 functions is listed in Table C-2.

**Table C-2: Keyboard Mapping**

IND570 Keypad	External Keyboard	IND570 Keypad	External Keyboard
SK (soffkey) 1	F1	1	Numeric keypad 1
SK2	F2	2	Numeric keypad 2
SK3	F3	3	Numeric keypad 3
SK4	F4	4	Numeric keypad 4
SK5	F5	5	Numeric keypad 5
C (Clear)	F6 & Backspace	6	Numeric keypad 6
O (Zero)	F7	7	Numeric keypad 7
T (Tare)	F8	8	Numeric keypad 8
Print	F9	9	Numeric keypad 9
Enter	Enter	0	Numeric keypad 0
Left Arrow	Left arrow	.	Decimal
Right Arrow	Right arrow		
Up Arrow	Up arrow		
Down Arrow	Down arrow		

## C.2. Logical (User Definable) Connections

Table C-3 outlines all possible IND570 connection assignments by port.

**Table C-3: IND570 Connection Assignments, by Port**

Assignment	Port									
	COM				Enet1	Enet2	Enet3	Eprint	Print Client	USB
	1	2	3	4						
8142 Host*	X	X	X	X						
8530 Host*	X	X	X	X						
Action Log**	X	X	X	X	X			X	X	X
ASCII Input	X	X	X	X						X
Command Template*	X	X	X	X				X		
Continuous Extended	X	X	X	X	X			X	X	

Assignment	Port									
	COM				Enet1	Enet2	Enet3	Eprint	Print Client	USB
	1	2	3	4						
Continuous Output	X	X	X	X	X			X	X	
Continuous Short*	X	X	X	X	X			X	X	
Continuous Template	X	X	X	X	X			X	X	
CTPZ Input	X	X	X	X				X	X	
Demand Output	X	X	X	X	X	X	X	X	X	X
PT6S3*	X	X	X	X				X		
Remote Discrete I/O	X		X							
Remote Display	X	X	X	X				X		
Reports	X	X	X	X	X			X	X	X
Shared Data Server	X									
SICS	X	X	X	X				X		
SMA*	X	X	X	X						
Totals Report	X	X	X	X	X			X	X	X

\* Assignments only available when the COM-560 module is installed.

\*\* Assignments only available when the Fill-570 application software is installed.

## C.3. Inputs

### C.3.1. ASCII Input

With the IND570 terminal, a bar code scanner or other ASCII device can be connected to a port and used as an input device to enter ASCII data. This is done with the ASCII Input connection type. When this input type is selected, the assignment for the data received must also be specified at **Communication > Templates > Input**. Available assignments include:

- Application (TaskExpert program)
- ID1
- Keypad
- Tare
- Tare ID
- Target ID
- Target Weigh-in (Fill-570 feature only)

- Target Weigh-out (Fill-570 feature only)

As part of the programming for using the ASCII input, an input template must be configured. The template feature permits removal of a preamble (preceding characters) and a postamble (trailing characters) that are not part of the desired data. These parameters set the number of characters to be ignored before and after the incoming data. These will be the same for each data input string that the IND570 receives from a barcode scan.

An input will be terminated after the receipt of the programmable "Termination Character" or after a 1 second timeout where no new characters are received. At this time, any input data that has been collected will be applied to the assignment that has been selected. This could be an actual value such as a preset tare value (Tare) or a response for IDs (Keypad), or it could initiate a look-up into the tare or target table if Tare ID or Target ID is selected as the input template assignment.

The following notes apply to how the ASCII input is handled through the input template:

- The **Preamble Length** selects how many characters should be skipped at the beginning of an input string before the desired data.
- **Data Length** defines the maximum length of a string. All characters beginning after the Preamble through the Length selection will be used as the input.
- The **Postamble length** is the number of characters (before the Termination Character) that will be stripped off the data string. All other data from the Preamble Length to the Termination Character minus the Postamble Length will be used as the input string. When using an input that is always the same fixed length, this field would remain blank.
- The **Termination Character** is used to signal the end of the string input. It can be any ASCII control character. If "None" is selected, the 1 second timeout feature will terminate the entry.

#### C.3.1.1. Input Template Example

Preamble of 2, Data length of 5, Postamble of 0, Termination Character of <CR>, Input assignment of Tare.

Data received is: <STX>P001.5 kg<CR>

The preamble of 2 removes the <STX> and P characters. The next 5 characters of 001.5 are the actual data. The postamble is set to 0 because the data field has already been filled so no characters have to be removed. The <CR> terminates the input.

This string would input 1.5 as a preset tare to the IND570.

This same data could be obtained by programming a Preamble of 2, Data length of 8, Postamble of 3, Termination Character of <CR>. The Postamble length of 3 would remove the <space>kg from the data field since they are the last 3 characters received in front of the <CR>.

#### C.3.2. CTPZ

The CTPZ input mode provides a method for a remote serial device to trigger several basic functions when a control character is sent to the IND570. Remote ASCII control characters and the IND570 terminal responses include:

- C – Clears the scale to gross
- T – Tares the scale (causes a pushbutton tare)
- P – Initiates a print command
- Z – Zeros the scale

All other characters are ignored.

■ ASCII control characters can be sent in upper- or lower-case.

### C.3.2.1. CTPZ Application Example

To initiate a pushbutton tare from a remote device, program an IND570 connection port for CTPZ Input. Program the port parameters to match the remote device. Send the ASCII character “T” from the remote device and the IND570 will attempt to execute a tare.

### C.3.2.2. Command Template

The Command Template feature is available with the COM-560 module is installed in the IND570. The Command Template allows the user to define alternative characters to replace the standard C, T, P, Z input commands. The IND570 will execute the clear, tare, print or zero command when it receives the alternative ASCII character.

## C.4. Output Templates

The IND570 provides 10 templates that allow a user to define a custom string of data to be transmitted. A template can be used with a demand mode connection, a custom trigger connection or with a continuous template connection. In the setup of the terminal, a template is tied to an output connection so that when the trigger for that connection is activated, the selected template will be transmitted.

Of the 10 available output templates, 3 contain default setting, Template 1, Template 2 and Template 5 (Figure C-4). When no application software is installed in the IND570, the remaining templates are blank. Additional details on the content of the default templates can be found in Appendix A, **Default Settings**.

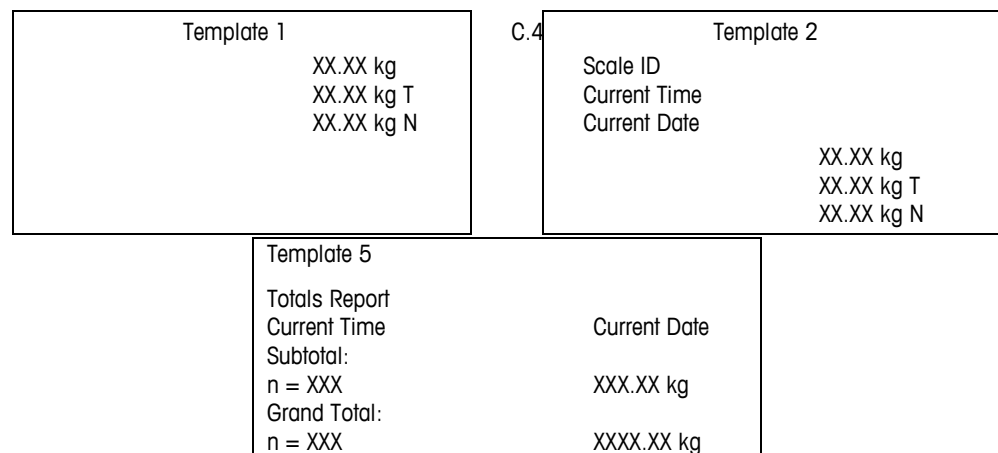

**Figure C-4: Default Content of Template 1, 2 and 5**

Each of the 10 available templates can store up to 1,000 bytes of data.

Table C-4 defines how the 1,000 bytes are calculated. There is no warning if a template overflows this limit until the template is saved. At this time, any information over the 1,000-byte limit will be lost.

Please contact your local Mettler-Toledo service provider if assistance is needed in creating custom output templates.

**Table C-4: Calculation of Template Data Bytes**

Print Field	Space Used
IND570 Data Field	8 characters
Special Character	4 characters + code (2 or 3 characters depending on the character)
String Field	String length + quantity (1 or 2)
Justify a Field	2 characters + justify letter (L, R, C) + space limit (1, 2, or 3 characters)
Zero Fill a Field	2 characters + Z + space limit (1, 2 or 3 characters)
Repeat Character	5 characters + number (1, 2 or 3 digits for number of times repeated)
Line end <CR><LF>	7 characters

**C.4.2. Template Example**

The following example shows a customer ticket that has three template strings centered in a 40-character wide field, with an asterisk underline.

```

GROSSBERG TRUCKING CO.
  CHAMPAIGN, ILLINOIS
    DAILY WEIGHT TOTALS
*****
    
```

Use the information in Table C-5 to calculate how much of the template remains for field data.

**Table C-5: Space Required for the Example Ticket Heading Information**

Character Description	Character Total
IND570 Field (String 1)	8 (IND570 shared data field)
Centered (Justify in 40-character field)	2 + 1 (letter C) + 2 (two digits for quantity 40)
CR (ASCII Carriage Return character)	2 + 1 (one digit for quantity 1)
LF (ASCII Line Feed character)	2 + 1 (one digit for quantity 1)
Total formatting characters required	19
Total space required (characters on each line)	25 + 19 + 19 = 63
ASCII (*) character	1 (ASCII character)
Repeat (*) 40 times	5 (repeat) + 2 (number of repeats)
CR	2 + 1 (one digit for quantity 1)
LF (ASCII Line Feed character)	2 + 1 (one digit for quantity 1)
Total space for line of asterisks	14
Grand total of characters (19 + 63 + 14)	96

Character Description	Character Total
Total characters remaining in this template (1,000 – 96)	904

- For template space calculation:

Regardless of the number of characters in an IND570 terminal data field, a template uses only eight characters (the field code).

Justification uses four to six characters that are not used if the field remains unjustified.

#### Repeat Print Notification

Output templates used for demand printing transactions have the option of being designated with a “DUPLICATE” header or footer if they are generated through the Repeat Print softkey.

```

DUPLICATE
GROSSBERG TRUCKING CO.
  CHAMPAIGN, ILLINOIS
    DAILY WEIGHT TOTALS
*****

```

or

```

GROSSBERG TRUCKING CO.
  CHAMPAIGN, ILLINOIS
    DAILY WEIGHT TOTALS
*****
DUPLICATE

```

## C.5. Communication Outputs

### C.5.1. Demand Output Mode

The Demand Output mode transmits data only when the IND570 terminal receives a demand output (Print) request. Print requests are sent to the IND570 terminal when:

- The operator presses the terminal PRINT key
- The operator presses any of the Custom Print Trigger  softkeys
- A discrete input selected as print or customer print trigger is activated
- An ASCII “P” is sent through a command input port
- Auto print is enabled and all conditions for auto print are met
- A PLC command to print is received
- The shared data command for “Print” is triggered

When a print is triggered, data is transmitted in a string which is configured in the template editing portion of setup (refer to section C.4, **Output Templates**). Demand Output mode is typically used when sending data to a printer, a PC or a USB memory stick a transactional basis.

### C.5.2. Custom Triggers

There are three programmable custom triggers in the Connections section of setup that can be used to “trigger” a specific demand output. A custom trigger can be used to provide a specialized “print” key that sends a specific output template to a specific port. Use of the custom triggers along with the terminals main PRINT function provides good flexibility in configuring on-demand data transmissions.

Activation of a custom print trigger will not trigger alibi logging, totalization or transaction counter updates.

- While it is not prohibited, it is recommended that custom print triggers only be used to transmit output templates that do not contain metrologically sensitive data (weight data).

### C.5.3. Ethernet Demand Output

If a demand output connection (or Reports connection) to Ethernet is made in the connections section of setup, a remote device may “register” to receive the data through the Ethernet port. In order to do this, the remote device must login to the shared data server and send the command to register for the data. The login can be any valid username and password for the terminal.

- When a user logs into the shared data server, he or she acquires the level of access for the username and password used. All levels of users can receive a demand string.

If a demand output connection to EPrint is made in the Connections section of setup, a remote device is not required to “register” with the Shared Data Server to receive the data through the Ethernet port. The data string simply contains the assigned template’s information. The EPrint connection is made via the secondary TCP/IP port at the user-defined port number. Refer to Chapter 3, **Configuration** for more details.

#### C.5.3.1. Registering for the Demand Output

The “printout” command allows the client to define a Demand Print Stream as a callback field. The Demand Print Streams include demand print (triggered by the scale) and custom triggers (triggers 1, 2, and 3). The console print server sends a message to the client at each print output. Since print messages can span multiple message blocks (depending upon size), the start of the print message has a <dprint> tag and the end of the message has a </dprint > tag. After registering for the demand output, the client will receive the appropriate data stream. The “ctimer” command specifies the minimum time between repeated callback messages. The “xprintout” command removes the registration from the terminal and the communication will stop.

- The “xgroup all” command will also terminate any demand output registrations.

#### C.5.3.2. Sequence Example 1

1. Enter the menu tree of setup.
2. In the Connections sub-block of the Communications block of setup, create a connection for Demand Output assignment to the Ethernet port triggered by Scale using Template 2.

3. Ensure that the IP and Gateway addresses are programmed properly.
4. Login to the shared data server from the client, (refer to the “user” command in section C.10.3.1).
5. Register to receive the demand data by entering the “printout 1” command.
6. The IND570 will acknowledge the registration with a message [00Gxxx~number PRINTOUT streams=1]. Now, whenever a demand print is generated, the Template 2 data will be sent to the client.

```
00P004 <dprint>Scale 1
01:33:10
06/Sep/2005
  17.08 lb
  17.08 lb T
  0.00 lb N
</dprint>
```

The “xprintout” command allows the client to remove the print output callback registration thus stopping the demand output.

#### **C.5.3.3. Sequence Example 2**

1. Enter the menu tree of setup.
2. In the Connections sub-block of the Communications block of setup, create a connection for Demand Output assignment to the Ethernet port triggered by Trigger 1 using Template 1.
3. Ensure that the IP and Gateway addresses are programmed properly.
4. Login to the shared data server from the client, (refer to the “user” command in section C.10.3.1).
5. Register to receive the demand data by entering the “printout 1” command.
6. The IND570 will acknowledge the registration with a message [00Gxxx~number PRINTOUT streams=1]. Now, whenever the custom trigger is initiated (by a programmed discrete input or PLC command), the Template 1 data will be sent to the client.

```
00P004 <dprint> 17.08 lb
  17.08 lb T
  0.00 lb N
</dprint>
```

The “xprintout” command allows the client to remove the print output callback registration thus stopping the demand output.



## C.6. Continuous Output Mode

The Continuous Output mode of the IND570 can be used to continuously send weight data and scale status information to a remote device such as a PC or a remote display.

### C.6.1. Standard Continuous Output

Continuous Output is also commonly known as MT Continuous or Mettler-Toledo Continuous. The fixed format data output consists of 17 or 18 bytes depending on whether or not the checksum character is enabled or disabled. The checksum is available on all ports. Non-significant weight data and tare data digits are transmitted as spaces. The continuous output mode provides compatibility with METTLER TOLEDO products that require real-time weight data. Table C-6 shows continuous format output.

**Table C-6: Continuous Output Format**

Character	Status <sup>2</sup>				Indicated Weight <sup>3</sup>					Tare Weight <sup>4</sup>					17	18		
	1	2	3	4	5	6	7	8	9	10	11	12	13	14			15	16
Data	STX <sup>1</sup>	SWA	SWB	SWC	MSD	-	-	-	-	LSD	MSD	-	-	-	-	LSD	CR <sup>5</sup>	CHK <sup>6</sup>

1. ASCII Start of Text character (02 hex), always transmitted.
2. Status words. Refer to Table C-7, Table C-8, and Table C-9 for details.
3. Displayed weight. Either gross or net weight. Six digits, no decimal point or sign. Insignificant leading zeroes are replaced with spaces.
4. Tare weight. Six digits of tare weight data. No decimal point in field.
5. ASCII Carriage Return <CR> character (0D hex).
6. Checksum, transmitted only if enabled in setup. Checksum is used to detect errors in the transmission of data. Checksum is defined as the 2's complement of the seven low order bits of the binary sum of all characters preceding the checksum character, including the <STX> and <CR> characters.

Table C-7, Table C-8, and Table C-9 detail the standard status bytes for standard continuous output.

**Table C-7: Status Word A Bit Definitions**

Bits 2, 1, and 0			
2	1	0	Decimal Point Location
0	0	0	XXXXX00
0	0	1	XXXXX0
0	1	0	XXXXXX
0	1	1	XXXXX.X
1	0	0	XXXX.XX
1	0	1	XXX.XXX

Bits 2, 1, and 0			
1	1	0	XX.XXXX
1	1	1	X.XXXXX
Bits 4 and 3			
4	3	<b>Build Code</b>	
0	1	X1	
1	0	X2	
1	1	X5	
<b>Bit 5</b>			Always = 1
<b>Bit 6</b>			Always = 0

**Table C-8: Status Word B Bit Definitions**

Status Bits	Function
Bit 0	Gross = 0, Net = 1
Bit 1	Sign, Positive = 0, Negative = 1
Bit 2	Out of Range = 1 (Over capacity or Under Zero)
Bit 3	Motion = 1, Stable = 0
Bit 4	lb = 0, kg = 1 (see also Status Byte 3, bits 0-2)
Bit 5	Always = 1
Bit 6	Zero Not Captured = 1

**Table C-9: Status Word C Bit Definitions**

Bits 2, 1, and 0			Weight Description
2	1	0	
0	0	0	lb or kg, selected by Status Byte B, bit 4
0	0	1	grams (g)
0	1	0	metric tons (t)
0	1	1	ounces (oz)
1	0	0	troy ounces (ozt)
1	0	1	penny weight (dwt)
1	1	0	tons (ton)
1	1	1	custom units

<b>Bit 3</b>	Print Request = 1
<b>Bit 4</b>	Expand Data x 10 = 1, Normal = 0
<b>Bit 5</b>	Always = 1
<b>Bit 6</b>	Always = 0

### C.6.2. Continuous Extended Output

Continuous Extended Output is a 24 byte message string that is an extension of the standard 17 bytes continuous output format. An optional checksum is can be enabled or disabled on all ports. The additional bytes serve to provide a node address and, optionally, custom application bits.

The IND570 terminal supports only the point-to-point application of the extended continuous format. The multi-drop application is not supported.

Table C-10 describes the continuous extended output format. The output takes the form shown here:

<SOH><ADR><SB-1><SB-2><SB-3><SB-4><WWWWWWWWW><TTTTTTT><CR><CKS>

**Table C-10: Format of Continuous – Extended Output**

	Status						Indicated Weight									Tare Weight									
Character	1	2	3	4	5	6	7	8	9	10	11	12	13	14	15	16	17	18	19	20	21	22	23	24	25
Data	SOH	ADR	SB1	SB2	SB3	SB4	W	W	W	W	W	W	W	W	W	T	T	T	T	T	T	T	T	CR	CKS
Note	A	B	C				D									E								F	G

1. ASCII Start of Header character (01H)
2. Address character – always 1(31H)
3. Status Bytes 1 to 4. Refer to Table C-11, Table C-12, Table C-13 and Table C-14.
4. Displayed weight (gross or net). Nine (9) ASCII digits including negative sign, decimal point. Leading zeros are set to spaces (20H). A minus sign (2DH) is sent immediately before the MSD for negative weights. Digits sent when data is invalid can be weight, zeros, or spaces (they should be ignored by receiving device). This field may also contain asynchronous error codes, when the data invalid bit is set.
5. Tare weight. Eight (8) ASCII digits including decimal point. Leading zeros set to spaces (20H).
6. ASCII carriage return (ODH).
7. Optional checksum. This character is the 2's complement of the sum of the 7 least significant bits of all preceding characters including the <SOH> and <CR>. The checksum character is transmitted with the same parity as all other characters.

Table C-11, Table C-12, Table C-13 and Table C-14 indicate the functions of status bytes 1, 2, 3 and 4.

**Table C-11: Status Byte 1 Definitions**

Bit 3	Bit 2	Bit 1	Bit 0	Units
0	0	0	0	None

Bit 3	Bit 2	Bit 1	Bit 0	Units
0	0	0	1	pounds
0	0	1	0	kilograms
0	0	1	1	grams
0	1	0	0	metric tons
0	1	0	1	tons
0	1	1	0	troy ounces
0	1	1	1	pennyweight
1	0	0	0	ounces
1	0	0	1	custom
1	0	1	0	reserved
1	0	1	1	reserved
1	1	0	0	reserved
1	1	0	1	reserved
1	1	1	0	reserved
1	1	1	1	reserved
<b>Bit 4</b>		Center of zero = 1		
<b>Bit 5</b>		Always = 1		
<b>Bit 6</b>		Weight in motion = 1		

**Table C-12: Status Byte 2 Definitions**

Bit	Description	
<b>Bit 0</b>	Gross or net mode, Net = 1	
<b>Bit 2</b>	<b>Bit 1</b>	<b>Tare type</b>
0	0	No tare
0	1	Auto or semi-auto tare
1	0	Preset tare
1	1	Tare memory
<b>Bit 4</b>	<b>Bit 3</b>	<b>Weight range</b>
0	0	Single range
0	1	Weight range 1
1	0	Weight range 2
1	1	Weight range 3
<b>Bit 5</b>	Always = 1	
<b>Bit 6</b>	Expanded by x10 = 1	

**Table C-13: Status Byte 3 Definitions**

Bit	Description
<b>0</b>	Data invalid = 1
<b>1</b>	Out of range under zero = 1
<b>2</b>	Out of range over capacity = 1
<b>3</b>	In power up (zero not captured) = 1

Bit	Description
4	Print initiated = 1
5	Always = 1
6	Below MinWeigh threshold = 1

**Table C-14: Status Byte 4 Definitions**

Bit	Description
0	Application Bit 1 (as0135)
1	Application Bit 2 (as0136)
2	Application Bit 3 (as0137)
3	Application Bit 4 (as0138)
4	Application Bit 5 (as0139)
5	Always = 1
6	Application Bit 6 (as0140)

■ Additional Notes on Continuous Extended Output

- If a tare weight has been identified as a Tare Memory type in Status Byte 2, it indicates that the value in the tare field might be a gross weight or a tare weight depending upon the application. This would be used when the terminal is programmed for net sign correction and the gross and tare weights have not been determined yet.
- The Data Invalid bit in Status Byte 3 indicates an overcapacity value, an under zero condition, or other conditions that indicate the weight value may not be valid. Any device reading the continuous output must monitor the Data Invalid bit and handle the data accordingly.
- The application bits in Status Byte 4 are used for specific functions by other terminals and are not use in the IND570 terminal.

**C.6.3. Continuous Template Output**

If Continuous Template is selected as the assignment for a connection, a custom string of data can be configured using one of the five available templates. When Continuous Template is assigned to an output port, the output rate will depend on the size of the template and the baud rate selected. The rate will vary from approximately once per second up to approximately 20 times per second. Refer to Table C-15 for estimated output rates of a 160 byte template.

**Table C-15: Continuous Template Output Rate**

Baud Rate	Outputs/Second	Baud Rate	Outputs/Second
300	1	9600	10
600	2	19200	12
1200	4	38400	14
2400	6	57600	16
4800	8	115200	18

The template is configured as explained in Chapter 3, **Configuration**, and this template has the same 1,000 byte size restrictions as described in section C.4, **Output Templates**. For optimum performance, the template used in continuous output should not exceed 200 characters.

#### **C.6.4. Ethernet Continuous Output**

If a continuous output type of connection to Eprint is made in the connections section of setup, a remote device is not required “register” with the Shared Data server, to receive data through the Ethernet port. The data string simply contains the assigned continuous output or template information. The Eprint connection is made via the secondary TCP/IP port at the user-defined secondary port number (configured in setup at **Communication>Network>Port**).

If a continuous output or continuous template output connection to Ethernet 1 is made in the connections section of setup, a remote device must “register” to receive the data through the Ethernet port. In order to do this, the remote device must login to the shared data server and send the command to “register” for the data. The login can be any valid username and password for the terminal.

- When a user logs onto the shared data server, they acquire the level of access for the username and password used. All levels of users can receive a continuous string.

##### **C.6.4.1. Registering for the Continuous Output**

The “contout” command allows the client to define the continuous output string as a callback field. The Console Print Server sends a message to the client at each continuous output. The continuous output message is either in the Standard METTLER TOLEDO Continuous Output format or in a continuous template format. The “ctimer” command specifies the minimum time between repeated callback messages. The “xcontout” command removes the registration from the terminal and the communication will stop.

- The “xgroup all” command will also terminate any continuous output registrations.

##### **C.6.4.2. Sequence Example**

1. Enter the menu tree of setup.
2. In the Connections sub-block of the Communications block of setup, create a connection for Continuous Output assignment to the Ethernet port triggered by Scale.
3. Ensure that the IP and Gateway addresses are programmed properly.
4. Login to the shared data server from the client, (refer to the “user” command in section C.10.3.1).
5. Register to receive the continuous data by entering the “contout” command.
6. The IND570 will acknowledge the registration with a message [00Gxxx~number CONTOUT streams=1]. Now, whenever a continuous output string is generated by the IND570, the data will be sent to the client.

```
00C148 14! 354 236
>
00C149 14! 354 236
>
```

```
00C150 14! 354 236
>
00C151 14! 354 236
```

The “xcontout” command allows the client to remove the continuous output callback registration thus stopping the continuous output.

The output rate of a Continuous type output over Ethernet is 20Hz by default. This rate cannot be modified through the terminal setup menu. However, the output rate can be modified by a Shared Data write to a field in the “cs” block of Shared Data. Please refer to the **IND570 Shared Data Reference**, available for download at [www.mt.com/IND570](http://www.mt.com/IND570), for specifics.

## C.7. Standard Interface Command Set (SICS) Protocol

The IND570 terminal supports the METTLER TOLEDO Standard Interface Command Set (MT-SICS), which is divided into four levels (0, 1, 2, 3), depending on the functionality of the device. The IND570 terminal supports parts of levels 0 and 1.

- MT-SICS level 0 – Command set for even the simplest device.
- MT-SICS level 1 – Extension of the command set for standard devices.

A feature of this concept is that the commands combined in MT-SICS level 0 and 1 are identical for all devices. Both the simplest weighing device to the fully expanded weighing workstation recognize the commands of MT-SICS levels 0 and 1.

### C.7.1. Version Number of the MT-SICS

Each level of the MT-SICS has its own version number, which can be requested with the command I1 from level 0. The IND570 supports:

- MT-SICS level 0, version 2.2x (except the I5 and ZI commands)
- MT-SICS level 1, version 2.2x

### C.7.2. Command Formats

Each command received by the scale via the data interface is acknowledged by a response of the device to the transmitter. Commands and responses are data strings with a fixed format. Commands sent to the IND570 terminal comprise one or more characters of the ASCII character set. Enter commands only in uppercase.

The parameters of the command must be separated from one another and from the command name by a space (ASCII 32 dec., in the examples shown in this section, a space is represented as \_).

Each command must be terminated by CR LF (ASCII 13 dec., 10 dec.)

The characters CR and LF, which can be inputted using the **ENTER** or **RETURN** key of most entry keypads, are not listed in this description. However, it is essential they be included for communication with the IND570 terminal.

### C.7.2.1. SICS Command Example

Command to tare the IND570 terminal:

"TA\_20.00\_lb" (The command terminator CR LF is not shown.)

### C.7.3. Response Formats

All responses sent by the IND570 terminal to the transmitter to acknowledge the received commands have one of the following formats:

- Response with weight value
- Response without weight value
- Error message

#### C.7.3.1. Format of the Response with Weight Value

A general description of the response with weight value as follows:



**ID** Response identification.

— Space (ASCII 32 dec.)

**Status** Status of the IND570 terminal. Refer to the description of the commands and responses in the sections below.

**Weight Value** Weighing result, shown as a number with 10 digits, including sign directly in front of the first digit. The weight value appears right justified. Preceding zeroes are suppressed with the exception of the zero to the left of the decimal point.

**Unit** Weight unit displayed.

**CR** Carriage Return (ASCII 13 dec.)

**LF** Line Feed (ASCII 10 dec.)

#### C.7.3.1.1. Example

Response with a stable weight value of 0.256 kg:

S \_ S \_ \_ \_ \_ \_ 0.256 \_ kg

■ CR LF is not shown

#### C.7.3.2. Format of the Response Without Weight Value

A general description of the response without weight value is as follows:





<b>ID</b>	Response identification.
–	Space (ASCII 32 dec.)
<b>Status</b>	Status of the IND570 terminal. Refer to the description of the commands and responses in the sections below.
<b>Parameters</b>	Command-dependent response code.
<b>CR</b>	Carriage Return (ASCII 13 dec.)
<b>LF</b>	Line Feed (ASCII 10 dec.)
■	CR LF is not shown in response

#### C.7.4. Error Messages

**ID   C<sub>R</sub>   L<sub>F</sub>**

ID – Error Identification

There are four different error messages. The identification always comprises two characters:

ES – Syntax error: The IND570 terminal has not recognized the received command.

ET – Transmission error: The scale has received a “faulty” command, such as a parity error.

EL – Logical error: The command is understood, the parameter is incorrect.

EI – Internal Error:

The command is understood but cannot be executed at this time.

CR – Carriage return (ASCII 13 dec.)

LF – Line Feed (ASCII 10 dec.)

■ CR LF is not shown in actual response

#### C.7.5. Tips for the Programmer

Tips for programming the IND570 terminal SICS protocol include:

##### C.7.5.1. Command and Response

Improve the dependability of application software by having the program evaluate the response of the IND570 terminal to a command. The response is the acknowledgment that the IND570 terminal has received the command.

##### C.7.5.2. Reset

When establishing communication between the IND570 terminal and system, send a reset command to the IND570 terminal to enable a start from a determined state. When the IND570 terminal or system is switched on or off, faulty characters can be received or sent.

##### C.7.5.3. Quotation Marks (“ ”)

Quotation marks included in the command responses are used to designate fields and will always be sent.

### C.7.6. Commands and Responses MT-SICS Level 0

The IND570 terminal receives a command from the system computer and acknowledges the command with an appropriate response. The following sections contain a detailed description of the command set in alphabetical order with the associated responses.

- Commands and responses are closed with CR and LF. These termination characters are not shown in the following description, but they must always be entered with commands or sent with responses.

The commands of MT-SICS level 0 are available with even the simplest devices that support the METTLER TOLEDO Standard Interface Command Set. Level 0 commands include:

IO	Inquiry of all implemented MT-SICS commands
I1	Inquiry of MT-SICS level and MT-SICS versions
I2	Inquiry of balance data
I3	Inquiry of balance SW version and type definition number
I4	Inquiry of serial number
S	Send stable weight value
SI	Send weight value immediately
SIR	Send weight value immediately and repeat
Z	Zero
@	Reset (clear out serial buffer)

The following are detailed descriptions of these Level 0 commands:

#### C.7.6.1. IO – INQUIRY OF ALL IMPLEMENTED MT-SICS COMMANDS

Command: IO – Inquiry of all implemented MT-SICS commands

Response:	IO B 0 "IO"	Level 0 "IO" command implemented
	IO B 0 "I1"	Level 0 "I1" command implemented
	IO B 0 "I2"	Level 0 "I2" command implemented
	IO B 0 "I3"	Level 0 "I3" command implemented
	IO B 0 "I4"	Level 0 "I4" command implemented
	IO B 0 "S"	Level 0 "S" command implemented
	IO B 0 "SI"	Level 0 "SI" command implemented
	IO B 0 "SIR"	Level 0 "SIR" command implemented
	IO B 0 "Z"	Level 0 "Z" command implemented
	IO B 0 "@"	Level 0 "@" command implemented

IO B 1 "D"	Level 1 "D" command implemented
IO B 1 "DW"	Level 1 "DW" command implemented
IO B 1 "K"	Level 1 "K1-K3" commands implemented
IO B 1 "SR"	Level 1 "SR" command implemented
IO B 1 "T"	Level 1 "T" command implemented
IO B 1 "TA"	Level 1 "TA" command implemented
IO B 1 "TAC"	Level 1 "TAC" command implemented
IO B 1 "TI"	Level 1 "TI" command implemented

Error Response: IO I - Cannot execute command at this time.

**C.7.6.2. I1 – INQUIRY OF MT-SICS LEVEL AND MT-SICS VERSIONS**

Command: I1 – Inquiry of MT-SICS level and MT-SICS versions

Response: I 1 \_ A \_ "1" \_ "2.2x" \_ "2.2x" \_ " " \_ " "

"1" Level 1 fully implemented

2.2x Level 0, version V2.2x

2.2x Level 1, version V2.2x

" " No MT-SICS 2 commands

" " No MT-SICS 3 commands

Error Response: I1 \_ I – Command understood, not executable at present.

- In the case of the MT-SICS level, only fully implemented levels are listed. In this case, only level 1 is fully implemented so level 0 is not specified.
- In the case of the MT-SICS version, all levels are specified even those only partially implemented.

**C.7.6.3. I2 – INQUIRY OF DATA**

Command: I2 – Inquiry of data.

Response: I2 \_ A \_ "IND570 \_ Standard \_ 50.00 kg"

Response: I2 \_ A \_ "IND570 \_ 570Fill \_ 50.00 kg"

- IND570 - Model number of terminal
- Standard - Basic model with no special application software
- 570Fill - Sent when an IND570 with Fill-570 installed is queried
- 50.00 kg - Capacity and primary unit of the base connected to the IND570

Error Response: I2 \_ I – Command understood, not executable at present.

- The number of characters of “text” depends on the application software and scale capacity.

#### **C.7.6.4. I3 – INQUIRY OF SW VERSION AND TYPE DEFINITION NUMBER**

Command I3: Inquiry of SW version number(s) and type definition number.

Response: I3 \_ A \_ “1.00”

1.00 – Firmware version of the IND570

Error Response: I3 \_ I – Command understood, not executable at present.

- The number of characters of “text” depends on the revision and device type.

#### **C.7.6.5. I4 – INQUIRY OF SERIAL NUMBER**

Command: I4 – Inquiry of serial number.

Response: I4 \_ A \_ “text”

Serial number as “text” (content of shared data xs0105 in IND570 terminal)

Error Response: I4 \_ I – Command understood, not executable at present.

##### **Example**

Command: I 4 – Inquiry of serial number

Response: I 4 \_ A \_ “B234589528”

- The serial number response is the content of the terminal serial number as entered in the setup.

#### **C.7.6.6. S – SEND STABLE WEIGHT VALUE**

Command: S – Send the current stable net weight.

Response:

S \_ S \_ WeightValue \_ Unit – Current stable weight value in current displayed units

S \_ I – The command is understood but cannot be executed at this time. (IND570 terminal is currently executing another command such as taring, or stability was not reached before timeout expired.)

S \_ + – IND570 in overload range.

S \_ - – IND570 in underload range.

##### **Example**

Command: S – Send a stable weight value.

Response: S \_ S \_ \_ \_ \_ 100.00 \_ kg. – The current, stable weight value is 100.00 kg.

- The terminal will wait for up to 3 seconds after receiving an “S” command for no-motion. If motion does not settle within this time, the command is aborted.

**C.7.6.7. SI – SEND WEIGHT VALUE IMMEDIATELY**

Command: SI – Send the current net weight value regardless of scale stability.

Response:

S \_ S \_ WeightValue \_ Unit – Stable weight value.

S \_ D \_ WeightValue \_ Unit – Non-stable weight value.

S \_ I – The command is understood but cannot be executed at this time. (scale currently executing another command).

S \_ + – IND570 in overload range.

S \_ - – IND570 in underload range.

**Example**

Command: SI – Send current weight value.

Response: S \_ D \_ \_ \_ \_ \_ 129.07 \_ kg – The current weight value is unstable and is 129.07kg.

- The response to the command SI is the last internal weight value (stable or not stable) before receipt of the command SI.
- Weight value is in the current displayed units.

**C.7.6.8. SIR – SEND WEIGHT VALUE IMMEDIATELY AND REPEAT**

Command: SIR – Send the net weight values repeatedly, regardless of scale stability.

Response:

S \_ S \_ WeightValue \_ Unit – Stable weight value.

S \_ D \_ WeightValue \_ Unit – Non-stable weight value.

S \_ I – The command is understood but cannot be executed at this time. (IND570 terminal is executing another command, such as tare).

S \_ + – IND570 in overload range.

S \_ - – IND570 in underload range.

**Example**

Command: SIR – Send current weight values at intervals.

Response:

S \_ D \_ \_ \_ \_ \_ 129.07 \_ kg

S \_ D \_ \_ \_ \_ \_ 129.08 \_ kg

S \_ D \_ \_ \_ \_ \_ 129.09 \_ kg

S \_ D \_ \_ \_ \_ \_ 129.09 \_ kg

S \_ D \_ \_ \_ \_ \_ 114.87 \_ kg

- The scale sends stable or non-stable weight values at intervals.
- SIR is overwritten and cancelled by the commands S, SI, SR, and @.
- The number of weight values per second depends on the scale type and will vary from approximately 6 (older IDNet bases) to approximately 18 (analog bases).
- Weight value is in the current displayed units.

#### **C.7.6.9. Z – ZERO**

Command: Z – Zero the scale.

Response:

Z \_ A – The following then holds:

Scale is in gross mode

Zero setting performed, (stability criterion and zero setting range complied with).

Z \_ I – The command is understood but cannot be executed at this time. (IND570 terminal is currently executing another command, such as tare, or timeout as stability was not reached.)

Z \_ + – Upper limit of zero setting range exceeded.

Z \_ - – Lower limit of zero setting range exceeded.

#### **Example**

Command: Z – Zero.

Response: Z \_ A – Zero setting performed.

- If enabled in setup a tare value will be cleared during zero setting.
- The zero point determined during switching on is not influenced by this command (the measurement ranges remain unchanged).
- The duration of the timeout is approximately one second.

#### **C.7.6.10. @ – RESET**

Command: @ – Reset the scale to the condition found after switching on, but without a zero setting being performed.

Response:

I 4 \_ A \_ "text" – Serial number of the scale, the scale is ready for operation.

#### **Example**

Command: @

Response: I4 \_ A \_ "123456-6GG" – The IND570 terminal is reset and sends the serial number.

- All commands awaiting responses are canceled.

- The "reset" command is always executed.
- A reset command received by the IND570 terminal during the calibration and test procedure cannot be processed.

### C.7.7. Commands and Responses MT-SICS Level 1

The following commands of MT-SICS level 1 are available:

- D – Display (display text string on IND570 display)
- DW – Weight Display (return to standard weight display - clear text transmitted with "D" command)
- K – Key control
- SR – Send weight value on weight change (Send and Repeat)
- T – Tare
- TA – Set tare value
- TAC – Clear tare value
- TI – Tare Immediately

#### C.7.7.1. D – WRITE TO TERMINAL DISPLAY

Command: D

D\_"text" (" " are required for proper command execution)

D " " (clears previously transmitted text from the Data line)

Response:

D\_A – Text appears unabridged, left-aligned in Data line just above the softkeys

D\_R – The end of the text appears in Data line. The start of the text is cut off and marked by the symbol "\*".

D\_I – Command is understood but cannot be executed at this time. (the IND570 terminal is currently executing another command, such as tare, or timeout as stability was not reached.)

D\_L – Command understood, parameter wrong.

#### Example

Command: D\_"HELLO"

Response: D\_A – "HELLO" appears in the Data line.

- The maximum number of characters of "text" visible in the Data line is 30. Above 30 characters, beginning characters in the string will be dropped represented with a "\*".

#### C.7.7.2. DW – DISPLAY STANDARD WEIGHT DISPLAY

Command: DW – Returns display to previous settings/status.

Response:

DW\_A – Display showing previous settings/status.

DW\_I – Command understood, parameter wrong.

### C.7.7.3.

#### K – KEY CONTROL

Command: K\_1 – When a key is pressed, execute the corresponding function, but do not send a reply.

K\_2 – When a key is pressed, do not execute the corresponding function and send nothing.

K\_3 – When a key is pressed, do not execute the key function but send the corresponding key code.

Key codes supported by K\_3 command:

Key	Key code	Key	Key code
Softkey 1	1	Enter	13
Softkey 2	2	1	49
Softkey 3	3	2	50
Softkey 4	4	3	51
Softkey 5	5	4	52
Clear	8	5	53
Zero	30	6	54
Tare	24	7	55
Print	23	8	56
Left	16	9	57
Right	18	0	48
Up	17	Shift	25
Down	19	Decimal	46

K\_4 –When a key is pressed, execute the corresponding function and send the key code.

Key codes supported by K\_4 command:

Key	Key code
Tare	1
Zero	2
Print	3

Response:

K\_A – Key control command understood and successfully executed.



K\_I – Key control command understood but not executable at present (e.g. terminal in setup mode)

K\_L – Command understood, parameter wrong.

### Example

Command: K\_1 (followed by press of TARE key on terminal keypad)

Response: Tare executed. No further response from terminal.

Command: K\_3 (followed by press of TARE key on terminal keypad)

Response: K\_C\_24. Tare is not executed on the terminal. "Keypad disabled" appears in terminal system line.

- K\_1 is the factory setting (default value).
- K\_1 is active after the reset (@) command.
- Only one K command is active at any one time.

#### C.7.7.4.

### SR – SEND WEIGHT VALUE ON WEIGHT CHANGE (SEND AND REPEAT)

Command: SR

S\_R\_PresetValue\_Unit – Send the current stable weight value and then continuously after every weight change greater or equal to the preset value a non-stable value followed by the next stable value, range = 1d to maximum load.

SR – If no preset value is entered, the weight change must be at least 12.5% of the last stable weight value, minimum = 30d.

Response:

S\_S\_WeightValue\_Unit – Current, stable weight value. Weight change.

S\_D\_WeightValue\_Unit – Non-stable weight value.

S\_S\_WeightValue\_Unit – Next stable weight value.

S\_I – The command is understood but cannot be executed at this time. (the IND570 terminal is currently executing another command, such as tare, or timeout as stability was not reached.)

S\_L – Command understood, parameter wrong.

S\_+ – IND570 in overload range.

S\_- – IND570 in underload range.

### Example

Command: S\_R\_0.50\_kg – Send the current stable weight value followed by every load change  $\geq 0.50$  kg.

Response:

S\_S\_\_\_\_\_100.00\_kg – Scale stable.

S \_ D \_ \_ \_ \_ \_ 115.23 \_ kg – More than 0.50 kg loaded.

S \_ S \_ \_ \_ \_ \_ 200.00 \_ kg – Scale again stable.

- SR is overwritten and cancelled by the commands S, SI, SIR, @ and hardware break.
- If, following a non-stable weight value, stability has not been reached within the timeout interval, the response "S \_ I " is sent and then a non-stable weight value. Timeout then starts again from the beginning.
- The preset value must be entered in the first unit that is the weight unit displayed after the IND570 terminal has been switched on.

#### **C.7.7.5. T – Tare**

Command: T – Tare a stable weight value

Response:

T\_S\_Weight\Value\_Unit – Tare performed. Stability criterion and tare range comply with settings. Current Tare weight value in current units is returned.

T\_ I – Tare not performed (scale is executing another command, zero setting, or stability timeout reached.)

T\_+ – Upper limit of tare range exceeded.

T\_- – Lower limit of tare range exceeded.

#### **Example**

Command: T

Response: T \_ S \_ \_ \_ \_ \_ 100.00\_kg – The IND570 has accepted a tare value of 100.00 kg.

- The new tare weight value overwrites tare memory.
- The duration of the timeout depends on the scale type and its settings. If motion does not settle within this time, the command is aborted.
- Clearing tare value: Refer to section C.7.7.7, the TAC command.

#### **C.7.7.6. TA – INQUIRE/ENTER TARE VALUE**

Command: TA – Inquiry of tare weight value

TA \_ Tare Preset Value \_ Unit – Entry of a tare value.

Response:

T A \_ A \_ TareWeight\Value \_ Unit – Current Tare weight value.

T A \_ I – The command is understood but cannot be executed at this time.(the IND570 terminal is currently executing another command, such as zero setting).

T A \_ L – Command understood, parameter wrong.

#### **Example**

Command: T A \_ 10.00 \_ kg – Load a preset tare of 10 kg.

Response: T A \_ A \_ \_ \_ \_ 10.00\_k g – The IND570 has accepted the 10.00 kg tare value.

- The existing tare will be overwritten by the preset tare weight value.
- The IND570 terminal will automatically round the inputted tare value to the current readability.
- The preset value must be entered in the current units.

#### **C.7.7.7. TAC – CLEAR TARE VALUE**

Command: TAC – Clear tare value.

Response:

TAC \_ A – Tare value cleared.

TAC \_ I – The command is understood but cannot be executed at this time. (the IND570 terminal is currently executing another command, such as zero setting, or timeout as stability was not reached).

#### **C.7.7.8. TI – TARE IMMEDIATELY**

Command: TI – Tare immediately, (store the current weight value, which can be stable or non-stable as tare weight value).

Response:

T I \_ S \_ WeightValue \_ Unit – Tare performed, stable tare value.

T I \_ D \_ WeightValue \_ Unit – Tare performed, non-stable tare value.

T I \_ I – The command is understood but cannot be executed at this time. (The IND570 terminal is currently executing another command, such as zero setting.)

T I \_ L – The command is understood, the parameter is wrong.

T I \_ + – Upper limit of tare range exceeded.

T I \_ - – Lower limit of tare range exceeded.

#### **Example**

Command: TI – Tare.

Response: T I \_ D \_ \_ \_ \_ 117.57 \_ kg – The tare memory holds a non-stable (dynamic) weight value.

- Any previous tare value will be overwritten by the new tare weight value.
- Even during a non-stable (dynamic) condition, a tare weight value can be determined. However, the tare value determined in this manner may not be accurate.
- The stored tare weight value is sent in the current units.

## C.8. Remote Discrete I/O (ARM100)

The IND570 provides the ability to expand the discrete input and output control to remote ARM100 devices. This ability is required when more than five inputs or eight outputs are used (these are limits of the internal discrete I/O options) or it may be beneficial to have all of the I/O external to the IND570 based on the application. A total of three sets of I/O are supported in the IND570. This could be configured as an internal discrete I/O option and two remote modules or all three sets of I/O could be ARM100 remote I/O modules.

The communication link from the IND570 terminal to the ARM100 remote discrete I/O module is an RTU-based RS-485 communication protocol. During power-up, if remote discrete I/O has been enabled, communication will be established between the IND570 terminal and the remote modules. Any communication errors will be shown on the system line of the IND570.

If the RS-485 link between the ARM100(s) and the IND570 is interrupted or disabled, the IND570 disables all active I/O as a precaution.

Since the communication link is RS-485, only COM1 and the optional COM3 may be programmed for use with the ARM100 (COM2 is RS-232 only). This communication uses both the input and output portions of the port so it cannot be shared with any other connections. When "Remote Discrete I/O" is selected as the assignment for COM1 or COM3, the communication parameters are automatically preset by the terminal and cannot be changed from the front panel - they can only be viewed. The parameters are:

- Baud Rate: 57600
- Data bits: 8
- Parity: None
- Flow Control: None
- Interface: RS-485

After wiring the ARM100 modules per the details in the **IND570 Installation Manual**, and selecting the Remote I/O assignment in the connections portion of setup, the remote modules should be operational and ready for assignment of the individual inputs and outputs.

When assigning functions to remote discrete I/O locations, the remote modules are addressed by 1.0.x for module #1, 2.0.x for module #2, and 3.0.x for module #3. Each module provides four inputs and six dry-contact relay outputs.

### Example

Tare assigned to discrete I/O input address 1.0.1.

This indicates that when input #1 is turned on in remote module #1, a tare will be taken.

## C.9. Report Printing

In order to print reports of IND570 memory tables, data logs and test results, a connection must be made with an assignment of **Reports**. When the Reports assignment is associated with a serial, Ethernet port, or USB port whenever a report is printed, it will be routed to the assigned port.

The format of the printed report is selectable in setup so that all reports have the same general format (width, header, etc.) Additional printable fields can be configured for the individual tare table and target table reports. The settings unique to these reports are found in setup at **Communication > Reports**.

The following reports can be printed from their respective view screens:

- Tare Table
- Target Table
- Message Table
- Totals Report
- Service Information Recall
- Terminal Status
- GWP and Calibration Test Results
- GWP Log
- Change Log
- Error Log
- Maintenance Log

The following reports can be viewed and printed using the REPORTS softkey :

- Alibi Memory
- Tare Table
- Target Table

### C.9.1. Table Reports

The Alibi Memory, Tare Table, and Target Table can be viewed and printed by an operator using pressing the REPORTS softkey . Results of the table view for the Tare Table and Target Table can be printed directly from the Reports page; the Alibi memory file can be printed once its view is accessed. The table report structures are based on the fields defined in the table and report configuration. Configuring the format of all printed reports is described in Chapter 3, **Configuration**.

In order to access the report function, the REPORTS softkey  must be added to the selection of softkeys on the home page.

### C.9.1.1. Viewing and Printing Tables





1. Press the REPORTS softkey . The Reports Selection Screen displays (Figure C-5). Only tables that have been enabled in setup are shown. The Tare Table will always be shown.



Figure C-5: View Reports Screen

2. Select the table to view from the Type selection box, or press the PRINT softkey  to print either the Tare or Target Table. Because the Alibi table is likely to be large, it cannot be printed directly from this screen; the table must be filtered and the results shown in the Alibi Search View screen before a print can be initiated. A "Reports" connection must be configured to enable the report print. Note that the available softkeys will change based on the selection of the type of report.
3. After selecting the report, press the VIEW TABLE softkey .
4. Use the Search Field selection boxes and associated data fields to enter specific search information to limit the search, or use the default "find all" character, the asterisk (\*) to view all records.
5. Press the Search softkey  to view the results of the search. Each of the tables can be printed from its Search View screen.

A sample of a 40-column wide report for each is shown in the following sections.

- All reports (except for the Totals Report, Calibration Test and GWP Test reports) can be printing in 40-column or 80-column wide format. The settings at **Communication > Reports > Format** determine if all reports are printed in a 40-column width or an 80-column width format.

## C.9.2. Report Examples

### C.9.2.1. Alibi Table

The alibi table can be viewed, printed or saved to USB memory. Alibi memory is viewed in the same way as a search and view of any other table in the terminal. It is accessible from the dedicated ALIBI softkey **Alibi**, the REPORTS softkey , the **USB** softkey or through the menu tree at **Application > Memory > Alibi**.



#### C.9.2.1.1. 40 Column Example

```
Alibi Memory Report
17:25:26      23/May/2014

23-May-2014   17:25:01      0000022
31.6 kg      0 kg T       31.6 kg N
```

```
*****
23-May-2014      17:26:38      0000023
26.09 kg        0 kg T      26.09 kg N
*****
23-May-2014      17:29:15      0000024
45.22 kg        0 kg T      45.22 kg N
*****
```

**C.9.2.2. Tare Table Report**

The tare table can be viewed, printed or transferred with the USB file transfer function. It is accessible from the dedicated TARE TABLE softkey , the REPORTS softkey , the **USB** softkey or through the menu tree at **Application > Memory > Tare Table**.

In the following report examples, all available fields were programmed to print. A (\*) record separator was selected for these reports.



**C.9.2.2.1. 40 Column Example**

If the first field on a line were disabled, it would not be printed and the field to the right would be shifted left. If a field on the right of a line were disabled, it would not print and that space would be blank. If all fields on a specific line were disabled, the complete line would be removed from the report.

Tare Memory Report

```
ID: 1              T: 26.4 kg
Desc: Blue Box #4
n:   54            Total:  52954.3 kg
*****
ID: 5              T:  3.7 kg
Desc: Green Bag #29
n:    7            Total:  25593.4 kg
*****
ID: 6              T: 23.3 kg
Desc: B16 Pallet
n:    0            Total:         0 kg
*****
```

**C.9.2.3. Target Table Report**

The target table can be viewed or printed. It is accessible from the dedicated TARGET TABLE softkey , the REPORTS softkey , the **USB** softkey or through the menu tree at **Application > Memory > Target Table**.

In the following report examples, all available fields were programmed to print. A (\*) record separator was selected for these reports. If Target Table Totalization is enabled at **Application > Memory > Target Table**, the n and Total fields are automatically printed in the report.

**C.9.2.3.1. 40 Column Report Example**

If the first field on a line were disabled, it would not be printed and the field to the right would be shifted left. If a field on the right of a line were disabled, it would not print and that space would be blank. If all fields on a specific line were disabled, the complete line would be removed from the report.

#### Target Memory Report

```
ID: 1                Target:  11.00 kg
Spill:   0.55         Fine:    0.4
+Tol:    0.1          -Tol:    0.1
Desc: White RT4 Gran
n:       9            Total:   99.19 kg
*****
ID: 2                Target:  12.35 kg
Spill:   0.48         Fine:    0.6
+Tol:    0.2          -Tol:    0.2
Desc: Mixture #7728
n:      17            Total:  209.95 kg
*****
ID: 3                Target:  23.85 kg
Spill:   0.3          Fine:    0.8
+Tol:    0.3          -Tol:    0.1
Desc: Yellow #40 Pel
n:      14            Total:  332.54 kg
*****
```

#### C.9.2.4. Message Table Report

The message table contains text that can be used in print templates. There are 99 records and each record can be up to 100 characters long. In the view of the message table, only the first 20 characters of the message string are shown. The message table report can only be printed from the Message Table sub-block at **Application > Memory** using the PRINT softkey . An example of the 40 column wide printed report is shown next. The 80 column report will also wrap if the line exceeds the 80 character limit.

##### C.9.2.4.1. 40 Column Example

Message Report

```
1 James Carey
*****
2 Communications
*****
3 101 East Main Street
*****
4 This is an example of what the view
of a string of more than forty characte
rs would look like in a report
*****
```

#### C.9.2.5. Totals Report

The totals report will print only the fields that have been enabled for the totalizing function. If the subtotal feature has been disabled, then that field will not display or print. The example below includes both the subtotal and grand total fields. The report format is always in a 40 column width for the totals report.

##### C.9.2.5.1. 40 Column Example

```
                                Totals report
14:25:39                        20/Jul/2007
Subtotal:
```



```
n = 6                               86.19 kg
Grand Total:
n = 27                              372.76 kg
```

**C.9.2.6. Service Information Recall Report**

The Service Info Recall report can be printed from the Service Info Recall view screen.

**C.9.2.6.1. 40 Column Report Example**

Service Information Report

For service, please contact:  
 METTLER TOLEDO  
 www.mt.com

```
-----
Cal. & GWP Expiration
! Calibration
  Date 01-26-2015
  No. Transactions 000000
-----
```

Service Alerts: (!)

```
2015/01/26 12:01:21 000080
  Calibration expired. Run Calibration Test.
```

```
-----
S/N: B23456893
IND570
METTLER TOLEDO
MEZZANINE HOPPER SCALE
-----
```

**C.9.2.7. Terminal Status Report**

The Terminal Status report can be printed from the Terminal Status view screen.

**C.9.2.7.1. 40 Column Report Example**

TERMINAL STATUS REPORT

```
Battery:                3.0V   3.0V
Excitation:              9.9V   9.9V
Signal Quality:          124.75
Current SDS Logins:      0
Total Weighments:        21
Peak Weight:             50.23kg
Average Peak Load:      26.615kg
Platform Overloads:      4
Platform Underloads:     59
Zero Commands:           7
Zero Command Failures:   3
Time On:                  0.14 Days
Use Time:                  0.11 Days
Internal Flash: 7.38MB/7.39MB Free/Total
USB Memory: 3976MB/3982MB Free/Total
-----
```

For service, please contact:  
 METTLER TOLEDO  
 www.mt.com

```
-----
Cal. & GWP Expiration
! Calibration
```

Date 01-26-2015  
No. Transactions 000000

-----  
Service Alerts: (!)  
2015/01/26 12:01:21 000080  
Calibration expired. Run Calibration Test.  
-----

Connected Devices  
Floor Scale  
2156  
S/N 2437737  
-----

SYSTEM INFO RECALL

Model: IND570  
S/N: B23456893  
Term. ID #1: IND570  
Term. ID #2: METTLER TOLEDO  
Term. ID #3: MEZZANINE HOPPER SCALE  
Base S/N: 02547784BR  
Software  
Boot: 30101168 1.00.0004  
Standard: 30094864 2.00.0023  
Fill-570: 1.00.0092  
Hardware  
Analog L/C  
Opt: E-Net  
Opt: Ethernet/IP (V2.16)

**C.9.2.8. Calibration Test Report**

A Calibration Test Report can be printed at the completion of all of the steps in a successful or failed calibration test procedure. Details on how to setup and run a stored calibration test can be found in Chapter 3, **Configuration**.

After progressing through all of the steps in the calibration test procedure, press the PRINT softkey  to print the calibration test report.

**C.9.2.8.1. Calibration Report Example**

```
Calibration Test Report  
  
15:23:44      12/Sept/2012  
  
IND570  
METTLER TOLEDO  
IND570  
Scale: B206688276  
  
User: COBURN  
  
Test Weight(s):  
      ID              Weight  
-----  
              523352      50  
              523369      50  
              523377      50  
              523362      50  
              523368      50
```

Weight Unit: kg

Warning Limit Status: PASSED

Test Status: PASSED

Warning +/-	Control +/-	Target	Actual	OK
0.0	0.0	0.0	0.0	-
0.2	0.5	50.0	50.0	-
0.4	0.8	100.0	100.0	-
0.6	1.2	150.0	150.0	-

**C.9.2.9. GWP Test Reports**

Test Reports for the GWP Tests of Sensitivity, Repeatability and Eccentricity can be printed at the completion of all of the steps in a successful or failed GWP test procedure. Details on how to setup and run a stored GWP test can be found in Chapter 2, **Operation** and Chapter 3, **Configuration**.

After progressing through all of the steps in the GWP test procedures the PRINT softkey  to print the GWP test report. An example of the GWP Repeatability Test report is show in the next section. Similar reports exist for the GWP Sensitivity and Eccentricity test results.

**C.9.2.9.1. GWP Report Example**

```

Repeatability Test Report

09:26:30          13/Sept/2012

IND570
METTLER TOLEDO
IND570
Scale: B206688276

User: JOZEFOWICZ

Test Weight(s):
      ID                      Weight
-----
                    523352          50
                    523369          50
                    523377          50
                    523362          50
                    523368          50

Weight Unit: kg

Warning Limit Status: PASSED
Test Status: PASSED

Warning Limit +/-: 0.10 kg
Control Limit +/-: 0.20 kg
Calculated Repeatability: 0.00 kg

Test Data
Target  Actual  Difference
-----

```

0.0	0.0	-
50.0	50.0	0.0
0.0	0.0	-
50.0	50.0	0.0
0.0	0.0	-
50.0	50.0	0.0
0.0	0.0	-
50.0	50.0	0.0
0.0	0.0	-
50.0	50.0	0.0

### **C.9.2.10. GWP Log Report**

The GWP Log can be viewed or printed through the menu tree at **Maintenance > Configure/View > GWP Log**.

#### **C.9.2.10.1. 40 Column Report Example**

GWP Log Report

18:03:47 23/May/2014

Date: 23-May-2014  
 Time: 17:53:59  
 User ID: COBURN  
 GWP Test: SENSITIVITY  
 Warning: FAILED  
 Status: FAILED

Date: 23-May-2014  
 Time: 17:54:47  
 User ID: Jozsefowicz  
 GWP Test: ECCENTRICITY  
 Warning: PASSED  
 Status: PASSED

## **C.10. Shared Data Access**

The majority of setup parameters, triggers and statuses in the IND570 are stored and routed through "Shared Data". This is a system of memory mapping that permits remote clients to send commands and receive data from the terminal. In order to access the shared data variables in the IND570, a remote client must login to the Shared Data Server. Access is provided through either the COM1 serial port or through the optional Ethernet port. Regardless of the method used, the same access is provided and the login procedure is very similar.

### **C.10.1. Shared Data Server Login**

Shared data access is available from the COM1 serial port, the optional WiFi port, and the optional Ethernet port.

#### **C.10.1.1. To Login to the Shared Data Server via COM1**

1. To enable communication with the Shared Data Server:

Delete all connections to the COM1 port of the IND570. In setup at **Communication > Serial**, ensure that port settings for COM1 are:

- 115.2 K baud
- 8 data bits
- No parity
- 1 stop bit

*or*

Move switch SW2-1 to its ON position. This permits communication with the Shared Data Server without deleting any connections that have been configured in setup. Setting SW2-1 to ON will cause the message "Test Mode" to appear in the system line until SW2-1 is turned OFF.

- To restore access to configured COM1 connections, remember to return SW2-1 to its original, OFF, position once Shared Data Server communication is ended.

*or*

At **Communication > Connections**, set the assignment of COM1 as "Shared Data Server". This setting allows communication with the Shared Data Server over COM1 without setting SW 2-1 to the ON position. At **Communication > Serial**, ensure that port settings for COM1 are:

- 115.2 K baud
- 8 data bits
- No parity
- 1 stop bit

*or*

From an external device already connected to COM1, send LOGON<CR><LF> to the IND570. This command will interrupt the normal operation of COM1 and temporarily switch it to a Shared Data Server connection. The message "COM1 – Shared Data Server" will be displayed in the system line while the terminal is in this mode. The shared data server will be available at the port settings already being used – there is no need to reset them. Skip steps 2 and 3 below.

2. Program the serial port of the remote device for:
  - 115.2 K baud
  - 8 data bits
  - No parity
  - 1 stop bit
3. Connect an RS-232 cable (or RS-422 or RS-485) between the remote client PC and the IND570 COM1 port.
4. Open a program to communicate with the IND570 (such as HyperTerminal).
5. Type: **user xxxxx** where **xxxxx** is a valid username programmed in the **Terminal > User** branch of the setup menu tree. The access level assigned to this username will determine which shared data variables will be accessible.

- a. The default user login is "admin".
6. If a password is required for the username entered in step 5, the terminal will display: **51 Enter password**. If no password is required, skip to step 8.
7. Type: **pass xxxxx** where **xxxxx** is the valid password for the username entered in step 5.
8. Response from IND570: **12 Access OK**.
9. The remote client is now logged onto the Shared Data Server.

#### **C.10.1.2. To Login to the Shared Data Server via Ethernet**

The shared data server is available via port 1701. For applications that have no access to port 1701, a second port can be enabled. To enable the second port, enter the desired port number at the **Communication > Network > Secondary Port** branch of the menu tree.

- To access the secondary port as the Shared Data Server, make sure there are no assignments for the EPRINT port. The EPRINT port also uses the secondary port and if there is an EPRINT assignment, the shared data server cannot be accessed on the secondary port.
1. Program appropriate IP and Gateway addresses into the IND570 in the **Communication > Network** branch of the menu tree.
  2. Connect a crossover cable between the remote client PC and the IND570.
  3. Open a program (such as HyperTerminal) in the client PC to communicate with the IND570.
  4. Create a TCP/IP connection to the IP address programmed in the IND570 at port 1701, or the port assigned using shared data variable xs0138.
  5. If the IP and Gateway addresses and the cable connection are correct, the IND570 will display **Ready for user**.
  6. Type: **user xxxxx** where **xxxxx** is a valid username programmed in the **Terminal > Users** branch of the setup menu tree. The access level of the username used will determine which shared data variables can be accessed.
    - The default user login is "admin".
  7. If a password is required for the username in the previous step, the terminal will display: **51 Enter password**. If no password is required, skip to step 9.
  8. Type: **pass xxxxx** where **xxxxx** is the valid password for the username entered in step 6.
  9. Response from IND570: **12 Access OK**.
  10. The remote client PC is now logged onto the Shared Data Server.

#### **C.10.1.3. To Log in to the Shared Data Server via WiFi**

The shared data server is available via the port programmed (default 1701). For applications that cannot access port 1701, the port number can be changed in setup at **Communication > Network > WiFi Port**.

- If no WiFi port assignment is made on the connections page, then the shared data server will be available at the programmed WiFi port.

- If an assignment is made for the WiFi port on the connections page, then the shared data server will no longer be available at the programmed WiFi port.
1. Program appropriate IP and Gateway addresses into the IND570 in setup at **Communication > WiFi Module**.
  2. Connect the remote client PC to the same network that includes the IND570 WiFi access point.
  3. In the client PC, open a program (such as HyperTerminal) to communicate with the IND570.
  4. Create a TCP/IP connection to the WiFi IP address programmed in the IND570 at port 1701, or to the port assigned using the WiFi Port setup step.
  5. If the IP and Gateway addresses and the network connection are correct, the PC will display **Ready for user**.
  6. Type: **user xxxxx** where **xxxxx** is a valid username programmed in setup at **Terminal > Users**. The access level of the username used will determine which shared data variables can be accessed.
  - The default user login is "admin".
  7. If a password is required for the username in the previous step, the terminal will display: **51 Enter password**. If no password is required, skip to step 9.
  8. Type: **pass xxxxx** where **xxxxx** is the valid password for the username entered in step 6.
  9. The IND570 will respond: **12 Access OK**.
  10. The remote client PC is now logged onto the Shared Data Server.

## C.10.2. Shared Data Server Logout

A specific sequence must be followed when exiting from Shared data access on the COM1 serial port and the optional Ethernet port. If the port is not closed properly, it will remain "busy" and will no longer be available for login. There are a maximum of five shared data server connections available in the IND570. If all of these ports are "busy" it will not be possible to login to the Shared Data Server. Cycling power on the IND570 will reset all ports.

### C.10.2.1. To Exit the Shared Data Server Using COM1

When data exchange with the Shared Data Server is complete, send the command "Quit". This will clear the Shared Data Server connection and allow reuse of this connection later.

If connection to the Shared Data Server was made by moving switch SW2-1 to its ON position, move SW2-1 back OFF at this time. This allows the COM1 port to be used for the assignment originally programmed again.

If connection to the Shared Data Server was made by using the LOGON command, after sending the "Quit" command, a LOGOF<CR><LF> command must be sent to reset the serial port back to its original use. The serial port can't be used as its original assignment until the "LOGOF" command is sent or until the terminal is powered off then back on again.

If the connection to the Shared Data Server was made by clearing all COM1 assignments or assigning COM1 as Shared Data Server, the COM1 port can now be reprogrammed as required.

### C.10.2.2. To Exit the Shared Data Server Using Ethernet

When data exchange with the shared data server is complete, send the command "Quit". This will clear the shared data server connection and allow reuse of this connection later.

### C.10.2.3. To Exit the Shared Data Server Using WiFi

When data exchange with the shared data server is complete, type: **Quit**. This will end the shared data server connection and allow it to be reused later.

- The shared data server can only accept five concurrent connections. Closing the PC program without sending the **quit** command will leave the connection open, and may prevent later access.

## C.10.3. Shared Data Server Commands

After connecting to the Shared Data Server in the IND570, several commands are available for use by the client. All commands can be given in either upper- or lower-case letters. The quotation marks shown are for clarity only and should not be transmitted. The valid commands are described in the following sections.

- **Response Format:** "read", "write", and "callback" message responses have a formatted header. The first two characters indicate the status. "00" is the success status. "99" is a failure status. The next character is the type of message, "R", "W", or "C". The next three characters are a sequence number, which cycles from 001 to 999, and then starts over again.

### C.10.3.1. "user" Command

A client must login to the SDSV using the "user" command before accessing Shared Data. The server validates the username and sends a response message back to the user. The SDSV responds with [Access OK] if no password is required or [Enter password] if a password is required.

A client can use only the "user", "pass", "help" and "quit" commands before successfully logging on.

**Format:** user username

**Response 1:** 12 Access OK

**Response 2:** 51 Enter Password

### C.10.3.2. "pass" Command

The user enters a password using the "pass" command. If the password is valid, the server displays the [Access OK] message. If not valid, the server displays the [No access] message.

**Format:** pass password

**Response:** 12 Access OK

### C.10.3.3. "help" Command

The "help" command returns the list of the valid commands for the IND570.



**Format:** help

**Response:** 02 USER PASS QUIT READ R WRITE W SYSTEM CALLBACK XCALLBACK  
GROUP RGROUP XGROUP CTIMER LOAD SAVE HELP NOOP  
CONTOUT XCOUNTOUT PRINTOUT XPRINTOUT

#### C.10.3.4. "quit" Command

The "quit" command terminates the TCP/IP connection.

**Format:** quit

**Response:** 52 Closing connection

#### C.10.3.5. "read" Command

The "read" command allows the client to read a list of one or more Shared Data fields. An individual field or an entire block can be read. If more than one field is requested, the fields should be separated by a space. If successful, the server responds with a separated list of values in ASCII format. The server separates individually requested fields with a "~"; and Shared Data separates items within a block with a "^". If an error is detected, the server responds with an error message. The maximum length of the reply message is 1,024 characters.

**Format:** read SDV#1 SDV#2

**Example 1:** read wt0101 wt0103

**Response 1:** 00R003~ 17.08~lb~

- The 003 that follows the R in this response example is an incremental counter that indicates the count of the interaction between the client and the Shared Data server. This number continues to increment regardless of the type of event (read, write, group, etc.)

**Example 2:** read sp0100 (reads entire block)

**Response 2:**

```
00R012~XP/0163M^1^^78^20.500000^0^0^0^1.200000^3.500000^0.150000^0.050000^
0^0.000000^0.000000^0^0^0^0^0^0^1^0.000000^0.000000^0.000000^0.000
000^~
```

- The 'read' command can be abbreviated to the letter "r" if desired.

#### C.10.3.6. "write" Command

The "write" command allows the client to write a list of one or more Shared Data fields. A single field or an entire block can be written. The maximum length of the write message is 1,024 characters. Items within a list of writes must be separated with a "~". You must separate items within a block with a "^".

**Format:** write SDVblock#1=value1^value2^ value3  
write SDV#1=value1~SDV#2=value2~SDV#3=value3

**Example 1:** write ak0100=abc^def^hij^lmn (writes fields into a block)

**Response 2:** 00W006~OK

**Example 2:** write aj0101=12.56~aj0150=987.653 (writes fields within a list)

Response 2: 00W007~OK

■ The “write” command can be abbreviated to the letter “w” if desired.

### **C.10.3.7. “system” Command**

The “system” command returns a description of the IND570 terminal. This is the same information that is shown on the Recall System Information screen of the IND570.

**Format:** system

**Response:**

00S001~ SYSTEM INFO RECALL

Model: IND570

S/N: B234589528

ID1: IND570

ID2: METTLER TOLEDO

ID3:

Software

Boot: 30101168 1.00.0002

Standard: 1.00.0027

Fill-570: 1.50

Hardware

Analog L/C

E-Net/USB

Opt: E-Net

Opt: Ethernet/IP(V2. 4)

### **C.10.3.8. “noop” Command**

The “noop” command performs no task; it checks communication and returns an [OK] response message.

**Format:** noop

**Response:** 00OK

### **C.10.3.9. “callback” Command**

The “callback” command allows the client to define one or more fields for which the Shared Data Server sends a message to the client when the value of the callback field changes. Only certain SDV may be included in a callback command. These SDV are noted by an “rc” or “rt” status in the column after the structure column in the Shared Data Reference Manual. These are mainly SDV that monitor triggers used in the terminal. SDV with a status of “na” are not real-time SDV and cannot be used in callbacks.

■ The **IND570 Shared Data Reference** is available for download at [www.mt.com/IND570](http://www.mt.com/IND570).

The callback message contains one or more changed field names and the new value for each field. A maximum of twelve callback fields can be specified. The "ctimer" command specifies the minimum time between repeated callback messages.

**Format:** callback SDV#1 SDV#2

**Example:** callback st0102 st0103 st0104

**Response 1:** 00B001~OK

**Response 2:** 00C005~st0102=0^st0103=1^st0104=1 (sent when all of the SDV change)

**Response 3:** 00C006~st0104=0 (sent when only st0104 changes)

#### C.10.3.10. "xcallback" Command

The "xcallback" command allows the client to remove one or more callback fields from the list of current SDV.

**Format:** xcallback SDV#1 SDV#2 or xcallback all (removes all callbacks)

**Example:** xcallback st0102 (removes st0102 SDV from callback)

**Response:** 00X008~OK

#### C.10.3.11. "group" Command

The "group" command allows the client to define a group of callback fields. The Shared Data Server sends a message to the client when the value of any field in the group changes. The group callback message contains the group number and the values of all fields in the group in the defined order. The "ctimer" command specifies the minimum time between repeated callback messages. The maximum number of groups is six, and the maximum number of fields in a group is twelve.

**Format:** group n SDV#1 SDV#2 SDV#3 (where n = the number of the group 1–6)

**Example:** group 5 st0103 st0104 st0107 (groups target feeding and tolerance SDV into one group)

**Response 1:** 00B019~OK

**Response 2:** 00C026~group5=0^1^0 (indicates status of all 3 SDV in group 5 whenever any one of them changes)

#### C.10.3.12. "rgroup" Command

The "rgroup" command allows the client to define a group of fields. The client can use the group number to read the entire group at once using the READ command. The maximum number of groups is six, and the maximum number of fields in a group is twelve.

**Format:** rgroup n SDV#1 SDV#2 (where n = the number of the group 1–6)

**Example:** rgroup 3 di0101 di0102 di0103 di0104 (groups all discrete inputs into one group that can be read with a single read command)

**Response:** 0G008~group=3, number fields=4

**Read Example:** r 3

**Response:** 00R009~1~0~1~0~

#### **C.10.3.13. "xgroup" Command**

The "xgroup" command allows the client to remove one or all groups.

**Format:** xgroup n (where n = the group number 1 - 6) or XGROUP all (removes all groups, including "contout" and "printout")

**Example:** xgroup 5 (cancels group 5)

**Response:** 00X011~group=5

#### **C.10.3.14. "contout" Command**

The "contout" command allows the client to define an available continuous output string as a callback field. The continuous output message can be any of the following formats:

- Standard METTLER TOLEDO Continuous Output
- Extended METTLER TOLEDO Continuous Output
- Continuous custom template

The "ctimer" command specifies the minimum time between repeated callback messages. The "xcontout" command removes the registration from the terminal and the communication will stop.

**Format:** contout

**Response:** 00G600~number CONTOUT streams=1

When a continuous output occurs to the Ethernet port, the data will be sent to the client formatted as selected in setup.

**Data:** 00C004 14! 354 236

#### **C.10.3.15. "xcontout" Command**

The "xcontout" command allows the client to remove the continuous output callback, thus ending the registration so no further continuous outputs will be available.

**Format:** xcontout

**Response:** 00X070~CONTOUT

#### **C.10.3.16. "printout" Command**

The "printout" command allows the client to define a Demand Output data stream as a callback field. The Demand Output data streams include demand outputs triggered by the scale PRINT and custom triggers 1, 2 and 3. Since print messages can span multiple message blocks (depending upon size), the start of the print message has a <dprint> tag and the end of the message has a

</dprint > tag. After registering for the demand output, the client will receive the appropriate data stream.

The "ctimer" command specifies the minimum time between repeated callback messages.

The "xprintout" command removes the registration from the terminal and the communication will stop.

**Format:** printout

**Response:** 00G008~number PRINTOUT streams=1

When a demand output occurs to the Ethernet port, the data will be sent to the client formatted by the selected template. There will be <dprint> and </dprint> delimiters for the string.

**Data:** 00P004 <dprint> 22.08 lb  
17.06 lb T  
5.02 lb N  
</dprint>

#### C.10.3.17. "xprintout" Command

The "xprintout" command allows the client to remove the print output callback, thus ending the registration so no further demand outputs will be available.

**Format:** xprintout

**Response:** 00X070~PRINTOUT

#### C.10.3.18. "ctimer" Command

The "ctimer" command allows the client to set the minimum time between repeated callback messages in milliseconds. The minimum allowable setting is 50 milliseconds and the maximum is 60 seconds. The default value is 500 milliseconds.

**Format:** ctimer n (where n is the number of milliseconds)

**Example:** ctimer 1000 (set the callback timing to 1 second)

**Response:** 00T862~new timeout=1000

#### C.10.3.19. "csave" Command

The "csave" command saves the current callback and group settings into Shared Data for use later with the "cload" command.

**Format:** csave

**Response:** 00L004~OK

#### C.10.3.20. "cload" Command

The "cload" command loads the callback and group settings from Shared Data into the shared data server. The terminal will begin to service the loaded callback and group commands.

**Format:** cload

**Response:** 00L001~OK

#### **C.10.4. Using Shared Data to Select Target Table and Tare Table Records**

Target and Tare records can be recalled from their respective memory tables using the Shared Data Server commands.

The following section outlines the sequence of steps that must followed to recall memory table records using SDV.

##### **C.10.4.1. Recalling a Target Table Record or Tare Table Record to Active Status:**

To recall a Target Table or Tare Table record from a memory table, the first step is to specify the Tare or Target record ID. Then a command is issued to recall this specified record ID from either the Tare Table or the Target Table.

1. Log into Shared Data server as directed in previous sections.
2. Using Shared Data field qc0190, write the numeric ID of the record that you wish to recall from either the Target Table or the Tare Table. Numeric ID is a maximum two or three digit value (1-199) depending on which table is accessed.
3. Format: **w qc0190 X** (where X is the desired record ID)
4. Next, write a 1, 6, 11 or a 16 to Shared Data field qc0189. Writing a "1" will recall the record ID written to qc0190 from the Tare Table and set it as the active tare value. Writing a "6" will recall the record ID written to qc0190 from the Target Table and set it as the active target values.
  - Note: Writing "11" into qc0189 will set the record ID as the active Weigh-in Target ID for the Fill-570. Writing "16" into qc0189 will set the record ID as the active Weigh-out Target ID for the Fill-570.
5. The terminal will then load the identified record ID from the specified table for use.

#### **C.10.5. Ethernet Continuous Output**

If a continuous output type of connection to Eprint is made in the connections section of setup, a remote device is not required "register" with the Shared Data server, to receive data through the Ethernet port. The data string simply contains the assigned continuous output or template information. The Eprint connection is made via the secondary TCP/IP port at the user-defined secondary port number (configured in setup at Communication>Network>Port).

If a continuous output or continuous template output connection to Ethernet 1 is made in the connections section of setup, a remote device must "register" to receive the data through the Ethernet port. In order to do this, the remote device must login to the shared data server and send the command to "register" for the data. The login can be any valid username and password for the terminal.

- When a user logs onto the shared data server, they acquire the level of access for the username and password used. All levels of users can receive a continuous string.

### C.10.5.1. Registering for the Continuous Output

The "contout" command allows the client to define the continuous output string as a callback field. The Console Print Server sends a message to the client at each continuous output. The continuous output message is either in the Standard METTLER TOLEDO Continuous Output format or in a continuous template format. The "ctimer" command specifies the minimum time between repeated callback messages. The "xcontout" command removes the registration from the terminal and the communication will stop.

- The "xgroup all" command will also terminate any continuous output registrations.

### C.10.5.2. Sequence Example

1. Enter the setup menu tree.
2. In the Connections sub-block of the Communications block of setup, create a connection for Continuous Output assignment to the Ethernet port triggered by Scale.
3. Ensure that the IP and Gateway addresses are programmed properly.
4. Login to the shared data server from the client, (refer to the "user" command in section C.10.3.1).
5. Register to receive the continuous data by entering the "contout" command.
6. The IND570 will acknowledge the registration with a message [00Gxxx~number CONTOUT streams=1]. Now, whenever a continuous output string is generated by the IND570, the data will be sent to the client.

```
00C148 14! 354 236
>
00C149 14! 354 236
>
00C150 14! 354 236
>
00C151 14! 354 236
```

The "xcontout" command allows the client to remove the continuous output callback registration thus stopping the continuous output.

The output rate of a Continuous type output over Ethernet is 20Hz by default. This rate cannot be modified through the terminal setup menu. However, the output rate can be modified by a Shared Data write to a field in the "cs" block of Shared Data. Please refer to the [IND570 Shared Data Reference](#), available for download at [www.mt.com/IND570](http://www.mt.com/IND570), for specifics.

## C.11. File Transfer

The IND570 provides the ability to transfer files via Ethernet and WiFi using FTP (file transfer protocol) and via serial (COM1) using the 1K Xmodem protocol and the shared data server. Files can be transferred using the following commands.

- **fget** (serial) or **get** (Ethernet/WiFi) – all files can be read using this command

- **fput** (serial) or **put** (Ethernet/WiFi) – only certain files can be downloaded back to the IND570 terminal

In order to access any files from the IND570 via Ethernet or WiFi, the client must login to the FTP server. Valid usernames and passwords are entered in the setup under Communications, Network, FTP and each username is assigned an access level. All access levels can read files but only maintenance and administrator levels can write new files to the terminal (refer to Chapter 3, **Configuration** for further information about configuring FTP usernames, passwords, and access levels).

- The default login for the FTP server is username: **admin**, password: **admin**

Table C-16 indicates the path for the available files that can be accessed using Ethernet, WiFi or Serial file transfer.

**Table C-16: Access to Files via FTP**

Location	File Name	Description	Read from IND570	Write to IND570
gen:\	bkram.dmt	Setup parameters in battery backed RAM	✓	✓
	e2prom1.dmt	Scale calibration data	✓	✓
	flash.dmt	Setup parameters in flash	✓	✓
	intouch.xml	InTouch configuration	✓	✓
	change.csv	Change log	✓	
	errlog.csv	Error log	✓	
	gwplog.csv	GWP log	✓	
	maint.csv	Maintenance log	✓	
	systeminfo.txt	System Information	✓	
ram:\	caltest1.txt	Calibration test sequence	✓	✓
	caltw1.txt	Calibration test weight list	✓	✓
	eccfest1.txt	Eccentricity test sequence	✓	✓
	eccw1.txt	Eccentricity test weight list	✓	✓
	reptest1.txt	Repeatability test sequence	✓	✓
	reptw1.txt	Repeatability test weight list	✓	✓
	saver.bmp	Custom screen saver graphic	✓	✓
	senstest1.txt	Sensitivity test sequence	✓	✓
	senstw1.txt	Sensitivity test weight list	✓	✓
flash2:\	a1.csv	Tare table	✓	✓
	a2.csv	Target table	✓	✓
	a3.csv	TaskExpert table 3	✓	✓
		Permanent ID table (only in Drive-570)	✓	✓
	a4.csv	TaskExpert table 4	✓	✓
		Temporary ID table (only in Drive-570)	✓	✓
	cont.csv	Container tare table (only in Fill-570)	✓	✓
a5.csv	TaskExpert table 5	✓	✓	



Location	File Name	Description	Read from IND570	Write to IND570
	formula.csv	Formula table (Fill pac - A5)	✓	✓
	a6.csv	TaskExpert table 6	✓	✓
	a7.csv	TaskExpert table 7	✓	✓
	a8.csv	TaskExpert table 8	✓	✓
		Transaction table (Vehicle pac)	✓	
	a9.csv	TaskExpert table 9	✓	✓
	.cpt .bmp	TaskExpert custom program files and bitmaps (Includes application pacs created with TaskExpert such as Drive-570)	✓	✓
	cust.txt	Custom language files for display messages	✓	✓

### C.11.1. FTP over Ethernet or WiFi Example

The following procedure describes how one might upload the calibration test to a PC running Microsoft Windows, modify the file, and then download it again to the terminal.

A valid username and password from the FTP server of the IND570 terminal is required. Refer to Chapter 3, **Configuration**, Communication, Network, FTP.

The client must also know the IP address of the IND570 and a valid network connection established between the client and the terminal is required before beginning.

- For a wired Ethernet connection, refer to section C.1.2.1, **Ethernet Connection to a PC** earlier in this appendix.
  - For a WiFi connection, the IND570 must be connected to a wireless access point on the same network as the one to which the PC.
1. Open the command prompt window in the client PC and type: **ftp**
  2. Press ENTER. The command line should now display: **ftp>**.
  3. To open the FTP connection, type **open xxx.xxx.xxx.xxx** where the xxx.xxx.xxx.xxx represents the IP address of the IND570 terminal.
  4. Press ENTER. The display should indicate that service is ready and prompt for the username.
  5. Enter the username from the IND570 FTP user list.
  6. Press ENTER. If the username is valid, the display will prompt for a password.
  7. Enter the password for the username used.
  8. Press ENTER. If the login procedure was successful, the prompt line will now display: **ftp>**
  9. Enter the command: **get ram:\caltest1.cfg**
  10. Press ENTER. This command will upload the calibration test procedure to the directory that was showing in the command prompt line before the FTP program was started. The client screen should indicate that the transfer was successful.
  11. Modify the file as required. Refer to Appendix C for the file structure.

12. Download the modified file to the IND570 by typing:

```
put caltest1.cfg ram:\caltest.cfg
```

The client screen should indicate that the transfer was successful.

13. After the transfer is complete, type: **quit**

14. Press ENTER to exit the FTP process. An acknowledgment message: **Bye** displays.

15. Type: **exit**

16. Press ENTER to close the command line screen and return to Windows.

### C.11.2. File Transfer via COM1 Example

The following procedure describes how one might download a new Switch Units soffkey graphic (select.bmp) to an IND570 using a PC running HyperTerminal.

A valid username and password from the Shared Data Server of the IND570 terminal is required. Refer to the **Terminal, Users** section of Chapter 3, **Configuration**.

1. Connect a serial cable between the PC serial port and the IND570 terminal COM1 port.
2. Match the serial port parameters between the IND570 terminal and the PC then create a serial port connection to the IND570 terminal in HyperTerminal.
3. Login to the Shared Data Server per instructions given previously in the Shared Data Server Login section of this chapter using a valid username and password (if requested).
4. After logging into the Shared Data Server, the HyperTerminal display should show **Access OK**.
5. In HyperTerminal, type **fput flash2:\select.bmp**.
6. HyperTerminal should show OK on the screen then begin showing a series of capital letter "C"s indicating the IND570 terminal is ready to receive the file from the PC (Figure C-6).
7. In HyperTerminal, click on **Transfer** in the header ribbon then select "Send File" from the drop down box.

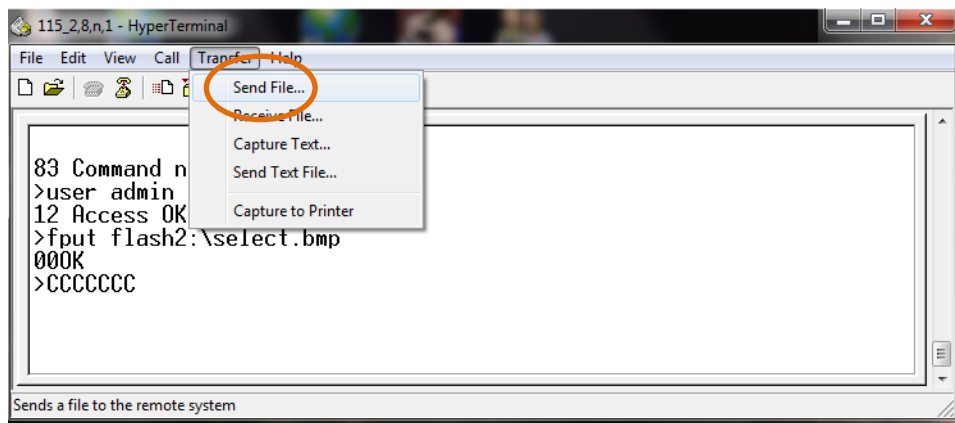

**Figure C-6: HyperTerminal Starting Display**

8. A pop-up box for sending files will be shown (Figure C-7).

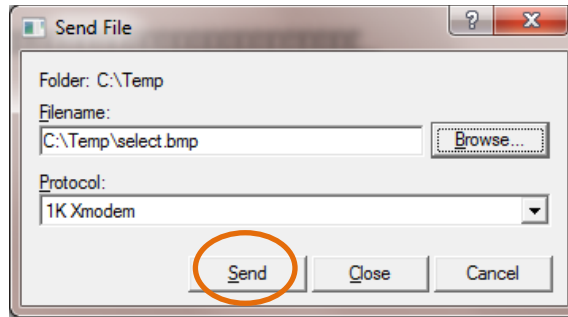

**Figure C-7: Serial File Transfer Screen**

9. In the pop-up box, to the right of the **Filename** box, use the Browse button to locate the file to be sent (select.bmp) then click on the "Open" button at the bottom of the browse window.
10. Select "1K Xmodem" in the Protocol drop-down box then click the "Send" button.
11. The Send File window will close and a transfer window will open. This window shows the progress of the file transfer (Figure C-8).

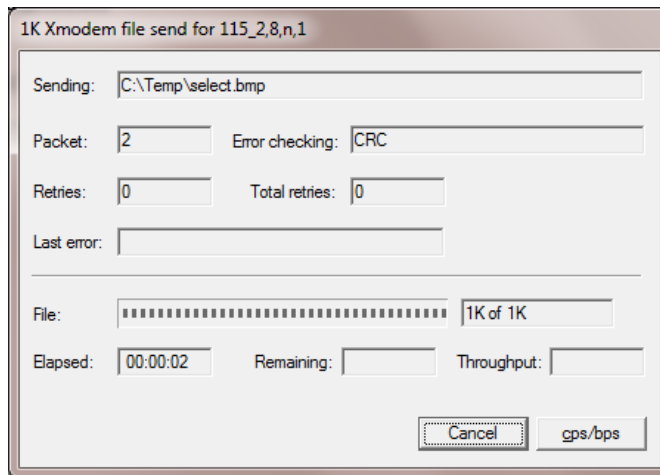

**Figure C-8: Windows Transfer Window**

12. When the file transfer is complete, the transfer window will close and HyperTerminal will show <OK> on the display (Figure C-9).

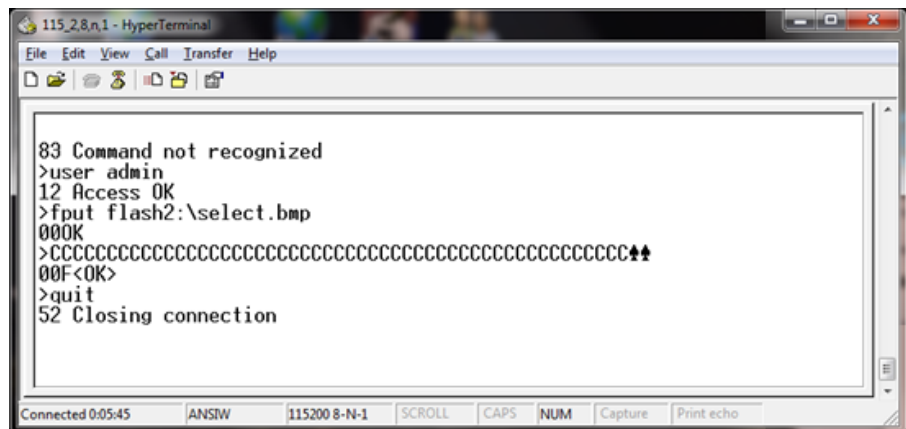

**Figure C-9: HyperTerminal Final Display**

13. After the transfer is complete, type **Quit** which will end the Shared Data Server session and follow the instructions for exiting the Shared Data Server connection provided earlier in this chapter.

## **C.12. Remote Display**

Refer to Chapter 4, **Applications**, for full details on configuring the IND570 to function as a remote terminal or remote display.

# D GEO Codes

The GEO code feature provided in the IND570 terminal permits calibration readjustment due to changes in elevation or latitude without reapplying test weights. This adjustment assumes a previously accurate calibration was done with the GEO code set properly for that original location and that the GEO code for the new location can be accurately determined. The procedure for using this feature is as follows.

## D.1. Original Site Calibration

1. Use the GEO code chart (Table D-1) on the following pages to determine the GEO code for the current altitude and location at which the scale will be calibrated.
2. Enter that GEO value into the GEO code parameter in setup at **Scale > Calibration**.
3. Immediately after entering the GEO code, perform a zero and span adjustment using accurate test weights.
4. Exit the setup menu tree.
5. The scale can now be used in its new location.

## D.2. New Site GEO Code Adjustment

When a terminal is to be reinstalled at a different geographic location, gravitational and altitude changes can be accounted for by following these steps. Note that this procedure is not necessary if an on-site recalibration is performed.

1. Use the GEO code chart (Table D-1) on the following pages to determine the GEO code for the new altitude and location at which the scale will be used.
2. Enter that GEO value into the GEO code parameter in Setup at **Scale > Calibration**.
3. Immediately after entering the GEO code, exit the setup menu tree. DO NOT perform a normal calibration.

The calibration has now been adjusted for the differences in gravity from the original site of calibration to the new site of use.

- Using the GEO code value for calibration adjustment is not as accurate as re-applying certified test weights and re-calibrating the scale in a new location.

**Table D-1: GEO Adjustment Values**

Latitude North or South, in Degrees and Minutes	Height Above Sea Level, in Meters										
	0	325	650	975	1300	1625	1950	2275	2600	2925	3250
	325	650	975	1300	1625	1950	2275	2600	2925	3250	3575
	Height Above Sea Level, in Feet										
	0	1060	2130	3200	4260	5330	6400	7460	8530	9600	10660
1060	2130	3200	4260	5330	6400	7460	8530	9600	10660	11730	
0° 0'–5° 46'	5	4	4	3	3	2	2	1	1	0	0
5° 46'–9° 52'	5	5	4	4	3	3	2	2	1	1	0
9° 52'–12° 44'	6	5	5	4	4	3	3	2	2	1	1
12° 44'–15° 6'	6	6	5	5	4	4	3	3	2	2	1
15° 6'–17° 0'	7	6	6	5	5	4	4	3	3	2	2
17° 10'–19° 2'	7	7	6	6	5	5	4	4	3	3	2
19° 2'–20° 45'	8	7	7	6	6	5	5	4	4	3	3
20° 45'–22° 22'	8	8	7	7	6	6	5	5	4	4	3
22° 22'–23° 54'	9	8	8	7	7	6	6	5	5	4	4
23° 54'–25° 21'	9	9	8	8	7	7	6	6	5	5	4
25° 21'–26° 45'	10	9	9	8	8	7	7	6	6	5	5
26° 45'–28° 6'	10	10	9	9	8	8	7	7	6	6	5
28° 6'–29° 25'	11	10	10	9	9	8	8	7	7	6	6
29° 25'–30° 41'	11	11	10	10	9	9	8	8	7	7	6
30° 41'–31° 56'	12	11	11	10	10	9	9	8	8	7	7
31° 56'–33° 9'	12	12	11	11	10	10	9	9	8	8	7
33° 9'–34° 21'	13	12	12	11	11	10	10	9	9	8	8
34° 21'–35° 31'	13	13	12	12	11	11	10	10	9	9	8
35° 31'–36° 41'	14	13	13	12	12	11	11	10	10	9	9
36° 41'–37° 50'	14	14	13	13	12	12	11	11	10	10	9
37° 50'–38° 58'	15	14	14	13	13	12	12	11	11	10	10
38° 58'–40° 5'	15	15	14	14	13	13	12	12	11	11	10
40° 5'–41° 12'	16	15	15	14	14	13	13	12	12	11	11
41° 12'–42° 19'	16	16	15	15	14	14	13	13	12	12	11
42° 19'–43° 26'	17	16	16	15	15	14	14	13	13	12	12
43° 26'–44° 32'	17	17	16	16	15	15	14	14	13	13	12
44° 32'–45° 38'	18	17	17	16	16	15	15	14	14	13	13

Latitude North or South, in Degrees and Minutes	Height Above Sea Level, in Meters										
	0	325	650	975	1300	1625	1950	2275	2600	2925	3250
	325	650	975	1300	1625	1950	2275	2600	2925	3250	3575
	Height Above Sea Level, in Feet										
	0	1060	2130	3200	4260	5330	6400	7460	8530	9600	10660
1060	2130	3200	4260	5330	6400	7460	8530	9600	10660	11730	
45° 38'–46° 45'	18	18	17	17	16	16	15	15	14	14	13
46° 45'–47° 51'	19	18	18	17	17	16	16	15	15	14	14
47° 51'–48° 58'	19	19	18	18	17	17	16	16	15	15	14
48° 58'–50° 6'	20	19	19	18	18	17	17	16	16	15	15
50° 6'–51° 13'	20	20	19	19	18	18	17	17	16	16	15
51° 13'–52° 22'	21	20	20	19	19	18	18	17	17	16	16
52° 22'–53° 31'	21	21	20	20	19	19	18	18	17	17	16
53° 31'–54° 41'	22	21	21	20	20	19	19	18	18	17	17
54° 41'–55° 52'	22	22	21	21	20	20	19	19	18	18	17
55° 52'–57° 4'	23	22	22	21	21	20	20	19	19	18	18
57° 4'–58° 17'	23	23	22	22	21	21	20	20	19	19	18
58° 17'–59° 32'	24	23	23	22	22	21	21	20	20	19	19
59° 32'–60° 49'	24	24	23	23	22	22	21	21	20	20	19
60° 49'–62° 9'	25	24	24	23	23	22	22	21	21	20	20
62° 9'–63° 30'	25	25	24	24	23	23	22	22	21	21	20
63° 30'–64° 55'	26	25	25	24	24	23	23	22	22	21	21
64° 55'–66° 24'	26	26	25	25	24	24	23	23	22	22	21
66° 24'–67° 57'	27	26	26	25	25	24	24	23	23	22	22
67° 57'–69° 35'	27	27	26	26	25	25	24	24	23	23	22
69° 5'–71° 21'	28	27	27	26	26	25	25	24	24	23	23
71° 21'–73° 16'	28	28	27	27	26	26	25	25	24	24	23
73° 16'–75° 24'	29	28	28	27	27	26	26	25	25	24	24
75° 24'–77° 52'	29	29	28	28	27	27	26	26	25	25	24
77° 52'–80° 56'	30	29	29	28	28	27	27	26	26	25	25
80° 56'–85° 45'	30	30	29	29	28	28	27	27	26	26	25
85° 45'–90° 00'	31	30	30	29	29	28	28	27	27	26	26

## METTLER TOLEDO Service

### To protect your METTLER TOLEDO product's future:

Congratulations on choosing the quality and precision of METTLER TOLEDO. Proper use according to these instructions and regular calibration and maintenance by our factory-trained service team ensure dependable and accurate operation, protecting your investment. Contact us about a METTLER TOLEDO service agreement tailored to your needs and budget.

We invite you to register your product at [www.mt.com/productregistration](http://www.mt.com/productregistration) so we can contact you about enhancements, updates and important notifications concerning your product.

[www.mt.com/IND570](http://www.mt.com/IND570)

For more information

**Mettler-Toledo, LLC**  
1900 Polaris Parkway  
Columbus, OH 43240

© 2019 Mettler-Toledo, LLC  
30205308 Rev. 13, 07/2019



30205308